

DENON

SUPER AUDIO CD PLAYER

DCD-CX3

Owner's Manual

Manuel de l'Utilisateur

Manual del usuario

SAFETY PRECAUTIONS



CAUTION
RISK OF ELECTRIC SHOCK
DO NOT OPEN



CAUTION:
TO REDUCE THE RISK OF ELECTRIC SHOCK, DO NOT REMOVE COVER (OR BACK). NO USER-SERVICEABLE PARTS INSIDE. REFER SERVICING TO QUALIFIED SERVICE PERSONNEL.

The lightning flash with arrowhead symbol, within an equilateral triangle, is intended to alert the user to the presence of uninsulated "dangerous voltage" within the product's enclosure that may be of sufficient magnitude to constitute a risk of electric shock to persons.

The exclamation point within an equilateral triangle is intended to alert the user to the presence of important operating and maintenance (servicing) instructions in the literature accompanying the appliance.

WARNING:
TO REDUCE THE RISK OF FIRE OR ELECTRIC SHOCK, DO NOT EXPOSE THIS APPLIANCE TO RAIN OR MOISTURE.

CAUTION:
USE OF CONTROLS OR ADJUSTMENTS OR PERFORMANCE OF PROCEDURES OTHER THAN THOSE SPECIFIED HEREIN MAY RESULT IN HAZARDOUS RADIATION EXPOSURE. THIS PRODUCT SHOULD NOT BE ADJUSTED OR REPAIRED BY ANYONE EXCEPT PROPERLY QUALIFIED SERVICE PERSONNEL.

Laser Class (IEC 60825-1:2001)

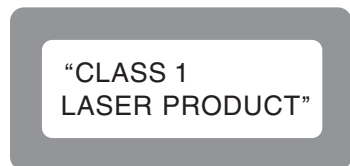

Copyrights / Droits d'auteur / Derechos de Autor

- It is prohibited by law to reproduce, broadcast, rent or play discs in public without the consent of the copyright holder.
- La reproduction, la diffusion, la location, le prêt ou la lecture publique de ces disques sont interdits sans le consentement du détenteur des droits d'auteur.
- De acuerdo con las leyes está prohibido reproducir, emitir, alquilar o interpretar discos en público sin la autorización del propietario de los derechos de autor.

IMPOTANT SAFETY INSTRUCTIONS

1. Read these instructions.
2. Keep these instructions.
3. Heed all warnings.
4. Follow all instructions.
5. Do not use this apparatus near water.
6. Clean only with dry cloth.
7. Do not block any ventilation openings. Install in accordance with the manufacturer's instructions.
8. Do not install near any heat sources such as radiators, heat registers, stoves, or other apparatus (including amplifiers) that produce heat.
9. Do not defeat the safety purpose of the polarized or grounding-type plug. A polarized plug has two blades with one wider than the other. A grounding type plug has two blades and a third grounding prong. The wide blade or the third prong are provided for your safety. If the provided plug does not fit into your outlet, consult an electrician for replacement of the obsolete outlet.
10. Protect the power cord from being walked on or pinched particularly at plugs, convenience receptacles, and the point where they exit from the apparatus.
11. Only use attachments/accessories specified by the manufacturer.
12. Use only with the cart, stand, tripod, bracket, or table specified by the manufacturer, or sold with the apparatus. When a cart is used, use caution when moving the cart/apparatus combination to avoid injury from tip-over.
13. Unplug this apparatus during lightning storms or when unused for long periods of time.
14. Refer all servicing to qualified service personnel. Servicing is required when the apparatus has been damaged in any way, such as power-supply cord or plug is damaged, liquid has been spilled or objects have fallen into the apparatus, the apparatus has been exposed to rain or moisture, does not operate normally, or has been dropped.
15. Batteries shall not be exposed to excessive heat such as sunshine, fire or the like.



CAUTION:

- The ventilation should not be impeded by covering the ventilation openings with items, such as newspapers, tablecloths, curtains, etc.
- No naked flame sources, such as lighted candles, should be placed on the unit.
- Observe and follow local regulations regarding battery disposal.
- Do not expose the unit to dripping or splashing fluids.
- Do not place objects filled with liquids, such as vases, on the unit.

ATTENTION:

- La ventilation ne doit pas être gênée en recouvrant les ouvertures de la ventilation avec des objets tels que journaux, rideaux, tissus, etc.
- Aucune flamme nue, par exemple une bougie, ne doit être placée sur l'appareil.
- Veillez à respecter les lois en vigueur lorsque vous jetez les piles usagées.
- L'appareil ne doit pas être exposé à l'eau ou à l'humidité.
- Ne pas poser d'objet contenant du liquide, par exemple un vase, sur l'appareil.

PRECAUCIÓN:

- La ventilación no debe quedar obstruida por haberse cubierto las aperturas con objetos como periódicos, manteles, cortinas, etc.
- No debe colocarse sobre el aparato ninguna fuente inflamable sin protección, como velas encendidas.
- A la hora de deshacerse de las pilas, respete la normativa para el cuidado del medio ambiente.
- No exponer el aparato al goteo o salpicaduras cuando se utilice.
- No colocar sobre el aparato objetos llenos de líquido, como jarros.

CAUTION:

To completely disconnect this product from the mains, disconnect the plug from the wall socket outlet. The mains plug is used to completely interrupt the power supply to the unit and must be within easy access by the user.

PRECAUTION:

Pour déconnecter complètement ce produit du courant secteur, débranchez la prise de la prise murale. La prise secteur est utilisée pour couper complètement l'alimentation de l'appareil et l'utilisateur doit pouvoir y accéder facilement.

PRECAUCIÓN:

Para desconectar completamente este producto de la alimentación eléctrica, desconecte el enchufe del enchufe de la pared. El enchufe de la alimentación eléctrica se utiliza para interrumpir por completo el suministro de alimentación eléctrica a la unidad y debe de encontrarse en un lugar al que el usuario tenga fácil acceso.

FCC INFORMATION (For US customers)

1. PRODUCT

This product complies with Part 15 of the FCC Rules. Operation is subject to the following two conditions: (1) this product may not cause harmful interference, and (2) this product must accept any interference received, including interference that may cause undesired operation.

2. IMPORTANT NOTICE: DO NOT MODIFY THIS PRODUCT

This product, when installed as indicated in the instructions contained in this manual, meets FCC requirements. Modification not expressly approved by DENON may void your authority, granted by the FCC, to use the product.

3. NOTE







This product has been tested and found to comply with the limits for a Class B digital device, pursuant to Part 15 of the FCC Rules. These limits are designed to provide reasonable protection against harmful interference in a residential installation.

This product generates, uses and can radiate radio frequency energy and, if not installed and used in accordance with the instructions, may cause harmful interference to radio communications. However, there is no guarantee that interference will not occur in a particular installation. If this product does cause harmful interference to radio or television reception, which can be determined by turning the product OFF and ON, the user is encouraged to try to correct the interference by one or more of the following measures:

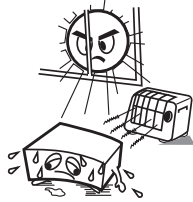
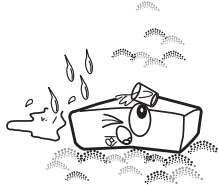
- Reorient or relocate the receiving antenna.
- Increase the separation between the equipment and receiver.
- Connect the product into an outlet on a circuit different from that to which the receiver is connected.
- Consult the local retailer authorized to distribute this type of product or an experienced radio/TV technician for help.

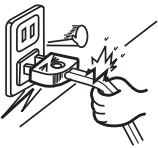
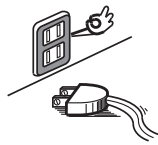
This Class B digital apparatus complies with Canadian ICES-003.
Cet appareil numérique de la classe B est conforme à la norme NMB-003 du Canada.

NOTE ON USE / OBSERVATIONS RELATIVES A L'UTILISATION / NOTAS SOBRE EL USO

| | | |
|--|---|--|
|  <ul style="list-style-type: none"> • Avoid high temperatures. Allow for sufficient heat dispersion when installed in a rack. • Éviter des températures élevées. Tenir compte d'une dispersion de chaleur suffisante lors de l'installation sur une étagère. • Evite altas temperaturas. Permite la suficiente dispersión del calor cuando está instalado en la consola. |  <ul style="list-style-type: none"> • Keep the unit free from moisture, water, and dust. • Protéger l'appareil contre l'humidité, l'eau et la poussière. • Mantenga el equipo libre de humedad, agua y polvo. |  <ul style="list-style-type: none"> • Do not let foreign objects into the unit. • Ne pas laisser des objets étrangers dans l'appareil. • No deje objetos extraños dentro del equipo. |
|  <ul style="list-style-type: none"> • Handle the power cord carefully. Hold the plug when unplugging the cord. • Manipuler le cordon d'alimentation avec précaution. Tenir la prise lors du débranchement du cordon. • Maneje el cordón de energía con cuidado. Sostenga el enchufe cuando desconecte el cordón de energía. |  <ul style="list-style-type: none"> • Unplug the power cord when not using the unit for long periods of time. • Débrancher le cordon d'alimentation lorsque l'appareil n'est pas utilisé pendant de longues périodes. • Desconecte el cordón de energía cuando no utilice el equipo por mucho tiempo. |  <ul style="list-style-type: none"> • Do not let insecticides, benzene, and thinner come in contact with the unit. • Ne pas mettre en contact des insecticides, du benzène et un diluant avec l'appareil. • No permita el contacto de insecticidas, gasolina y diluyentes con el equipo. |
|  <ul style="list-style-type: none"> • Do not obstruct the ventilation holes. • Ne pas obstruer les trous d'aération. • No obstruya los orificios de ventilación. | <p>* (For apparatuses with ventilation holes)</p> |  <ul style="list-style-type: none"> • Never disassemble or modify the unit in any way. • Ne jamais démonter ou modifier l'appareil d'une manière ou d'une autre. • Nunca desarme o modifique el equipo de ninguna manera. |

Contents

| | |
|--|---|
| Getting Started | |
| Accessories | 1 |
| Cautions on Handling | 2 |
| Cautions on Installation | 2 |
| About Discs | 2 |
| Discs that can be Played | 2 |
| Holding Discs | 3 |
| Loading Discs | 3 |
| Cautions on Loading Discs | 3 |
| Cautions on Handling | 3 |
| Cautions on Storing Discs | 3 |
| Cleaning Discs | 3 |
| About the Remote Control Unit | 4 |
| Inserting the Batteries | 4 |
| Operating range of the Remote Control Unit | 4 |
| Part Names and Functions | 5 |
| Front Panel | 5 |
| Display | 5 |
| Rear Panel | 5 |
| Remote Control Unit | 6 |
| Connections | |
| Cable Indications | 6 |
| Analog Connections | 7 |
| Digital Connections | 7 |
| Connecting the Power Cord | 7 |

| | |
|---|-------|
| Operations | |
| Before Playing | 8 |
| Turning the Power On | 8 |
| Setting the Layer to be Played with Priority | 8 |
| Loading Discs | 8 |
| Playing Discs with Even Higher Sound Quality (Pure Direct Mode) | 9 |
| Normal Playback | 9 |
| Various Types of Playback | 9 |
| Listening to Specific Tracks in a Specific Order (Programmed Playback) | 9, 10 |
| Listening in Random Order (Random Playback) | 10 |
| Listening to Tracks Repeatedly (Repeat Playback) | 10 |
| Displaying Text (Super Audio CDs only) | 10 |
| Displaying the Track Title | 10 |
| Displaying the Album Title | 10 |
| Displaying the Album's Artist Name | 10 |
| Playing Music files | 11 |
| Before Playing MP3 or WMA files | 11 |
| Creating MP3 and WMA files Compatible with the DCD-CX3 | 11 |
| Playing MP3 or WMA files | 12 |
| Listening to MP3 or WMA files in Random Order (Random Playback) | 12 |
| Listening to MP3 or WMA files Repeatedly (Repeat Folder/Disc Playback) | 12 |
| Using the Timer Play Function | 13 |
| Troubleshooting | |
| | 13 |
| Specifications | |
| | 14 |

Getting Started

Thank you for purchasing this DENON product. To ensure proper operation, please read these operating instructions carefully before using the product.
After reading them, be sure to keep them for future reference.

Accessories

Check that the following parts are supplied with the product.

| | |
|--|---|
| ① Owner's manual | 1 |
| ② Warranty (for North America model only) | 1 |
| ③ Service station list | 1 |
| ④ Power cord (Cord length: Approx. 6.5 ft / 2 m) | 1 |
| ⑤ Remote control (RC-1059) | 1 |
| ⑥ R03/AAA batteries | 2 |
| ⑦ Audio cable (Cable length: Approx. 3 ft / 1.0 m) | 1 |

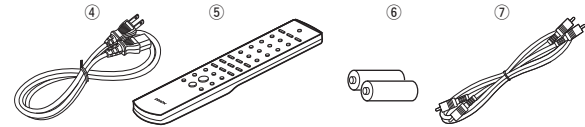

Cautions on Handling

• Before turning the power switch on

Check once again that all connections are correct and that there are no problems with the connection cables.

• Power is supplied to some of the circuitry even when the unit is set to the standby mode. When traveling or leaving home for long periods of time, be sure to unplug the Power cord from the power outlet.

• Sufficiently ventilate the place of installation

If the unit is left in a room full of the smoke from cigarettes, etc., for long periods of time, the surface of the optical pickup could get dirty, in which case it will not be able to read the signals properly.

• About condensation

If there is a major difference in temperature between the inside of the unit and the surroundings, condensation (dew) may form on the operating parts inside the unit, causing the unit not to operate properly.

If this happens, let the unit sit for an hour or two with the power turned off and wait until there is little difference in temperature before using the unit.

• Cautions on using mobile phones

Using a mobile phone near this unit may result in noise. If so, move the mobile phone away from this unit when it is in use.

• Moving the unit

First eject the disc, turn off the power, then unplug the power cord from the power outlet.

Next, disconnect the connection cables to other system units before moving the unit.

• Note that the illustrations in these instructions may differ from the actual unit for explanation purposes.

NOTE

This product uses a semiconductor laser. To ensure stable operation, it is recommended to use the product indoors at a temperature of 5 °C (41 °F) ~ 35 °C (95 °F).

Cautions on Installation

Note:

For proper heat dispersal, do not install this unit in a confined space, such as a bookcase or similar enclosure.

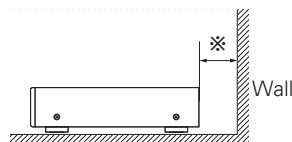
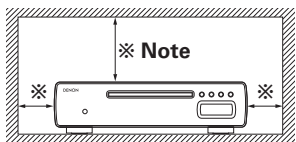

About Discs

Discs that can be Played

1 Super Audio CDs

Super Audio CDs marked with the logotypes indicated below can be played on this unit.



SUPER AUDIO CD



There are three types of Super Audio CDs:

- ① Single layer disc
Single layer Super Audio CD with only an HD layer.
- ② Dual layer disc
Super Audio CD with a double HD layer, offering extended playing time and high sound quality.
- ③ Hybrid disc
Two-layer Super Audio CD with an HD layer and a CD layer.
The signals on the CD layer can be played on a regular CD player.

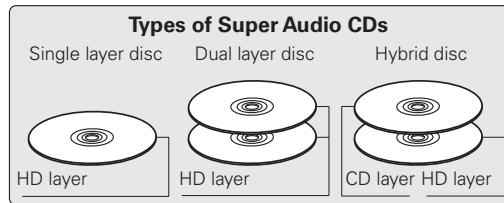

※ What is the HD layer?

The HD layer is a layer of high density signals for Super Audio CDs.

※ What is the CD layer?

The CD layer is the layer of signals that can be read on a regular CD player.



This unit is not compatible with multi-channel playback.

2 Music CDs

Discs marked with the logotype below can be played in this unit. Discs with special shapes (heart-shaped discs, octagonal discs, etc.) cannot be played. Do not attempt to play them, as doing so can damage the product.



3 CD-R/CD-RW

Some discs and some recording formats may not be playable. Non-finalized discs cannot be played.

※ What is finalization?

Finalization is the process that makes recorded CD-R/CD-RW discs playable on compatible players.

Holding Discs

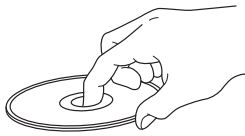

Do not touch the signal surface.

Loading Discs

- Set the disc with the labeled side facing up.
- Make sure the disc tray is fully open when inserting the disc.
- Place the discs flatly, 12 cm discs in the outer tray guide (Figure 1), 8 cm discs in the inner tray guide (Figure 2).

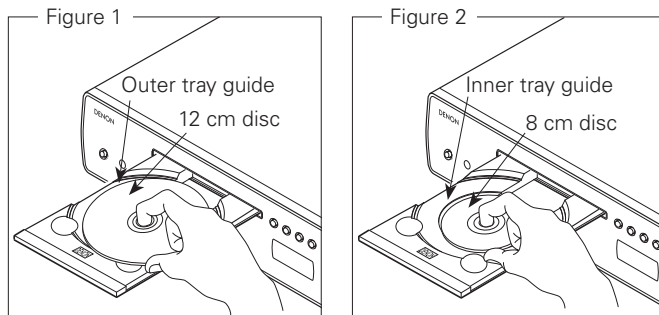

- Place 8 cm discs in the inner tray guide without using an adapter.



- "00:00" is displayed if a disc that cannot be played is loaded.
- "NO DISC" is displayed if the disc is loaded upside-down or if no disc is loaded.

Cautions on Loading Discs

- Only load one disc at a time. Loading two or more discs can damage the unit or scratch the discs.
- Do not use cracked or warped discs or discs that have been repaired with adhesive, etc.
- Do not use discs on which the sticky part of cellophane tape or labels is exposed or on which there are traces of where labels have been removed. Such discs can get caught inside the player and damage it.

Cautions on Handling

- Do not get fingerprints, oil or dirt on discs.
- Take special care not to scratch discs when removing them from their cases.
- Do not bend or heat discs.
- Do not enlarge the hole at the center.
- Do not write on the labeled (printed) surface with ball-point pens, pencils, etc., or stick new labels on discs.
- Water droplets may form on discs if they are moved suddenly from a cold place (outdoors for example) to a warm place, but do not try to dry them off using a hairdryer, etc.

Cautions on Storing Discs

- Be sure to remove discs after using them.
- Be sure to store discs in their cases to protect them from dust, scratches, warping, etc.
- Do not store discs in the following places:
 1. Places exposed to direct sunlight for long periods of time
 2. Dusty or humid places
 3. Places exposed to heat from heating appliances, etc.

Cleaning Discs

- If there are fingerprints or dirt on discs, wipe them off before using the disc. Fingerprints and dirt can impair sound quality and cause interruptions in playback.
- Use a commercially available disc cleaning set or a soft cloth to clean discs.

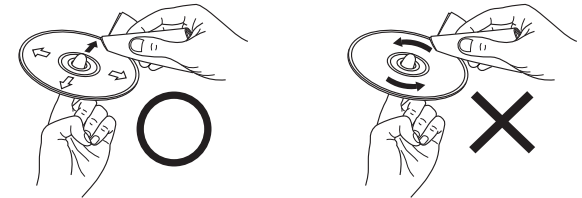

Gently wipe the disc from the inside towards the outside.

Do not wipe with a circular motion.

NOTE

Do not use record spray, antistatic agents, or benzene, thinner or other solvents.

About the Remote Control Unit

Inserting the Batteries

- ① Remove the remote control unit's rear cover.
- ② Set two R03/AAA batteries in the battery compartment in the indicated direction.

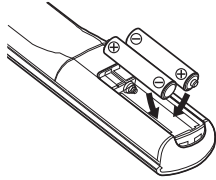
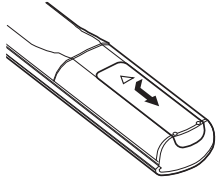

- ③ Put the rear cover back on.

NOTE

- Replace the batteries with new ones if the set does not operate even when the remote control unit is operated close to the unit.
- The supplied batteries are only for verifying operation.
- When inserting the batteries, be sure to do so in the proper direction, following the “+” and “-” marks in the battery compartment.
- To prevent damage or leakage of battery fluid:
 - Do not use a new battery together with an old one.
 - Do not use two different types of batteries.
 - Do not attempt to charge dry batteries.
 - Do not short-circuit, disassemble, heat or dispose of batteries in flames.
- If the battery fluid should leak, carefully wipe the fluid off the inside of the battery compartment and insert new batteries.
- Remove the batteries from the remote control unit if it will not be in use for long periods.

Operating Range of the Remote Control Unit

Point the remote control unit at the remote sensor when operating it.

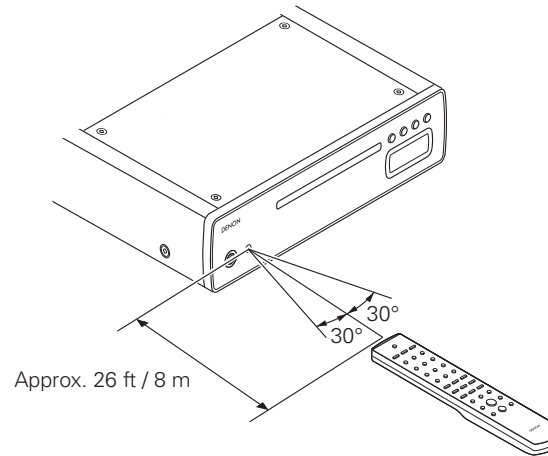

NOTE

The set may function improperly or the remote control unit may not operate if the remote control sensor is exposed to direct sunlight, strong artificial light from an inverter type fluorescent lamp or infrared light.

Part Names and Functions

For buttons not explained here, see the page indicated in parentheses ().

Front Panel

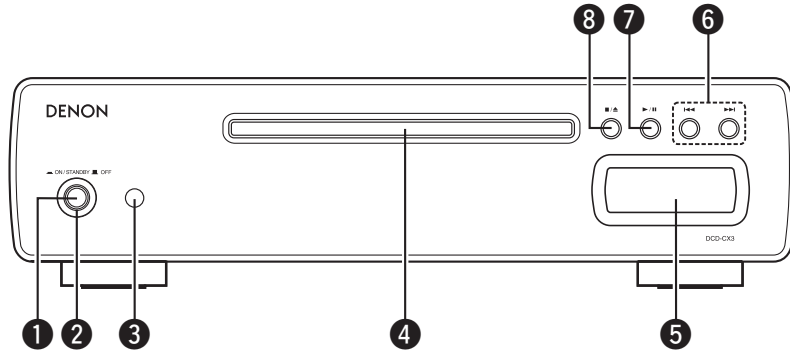

- ① Power switch (ON/STANDBY OFF) (8)
- ② Power indicator (8)
- ③ Remote control sensor (4)
- ④ Disc tray (3)
- ⑤ Display
- ⑥ Skip buttons (I◀◀, ▶▶I) (9, 12)
- ⑦ Play/Pause button (▶/||) (9, 10, 12)
- ⑧ Stop / Disc tray open/close button (■/▲) (8 ~ 10)

Display

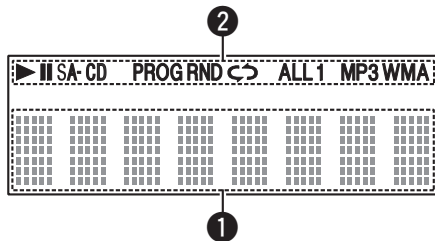

- ① Information display (8 ~ 12)
Various information is displayed here, depending on the operation mode.
- ② Mode indicators (9 ~ 12)

Rear Panel

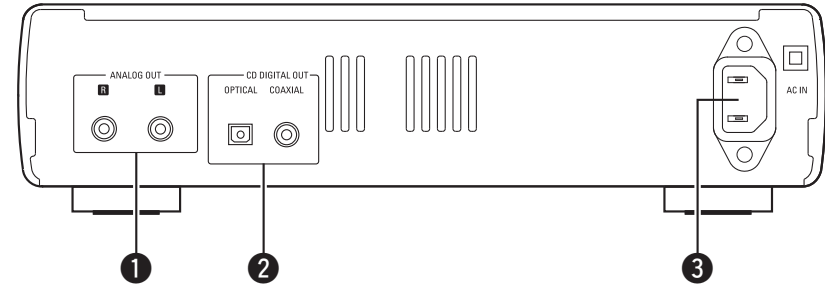

- ① ANALOG OUT terminals (7)
- ② CD DIGITAL OUT terminals (OPTICAL/COAXIAL) (7)
- ③ AC inlet (AC IN) (7)

Remote Control Unit

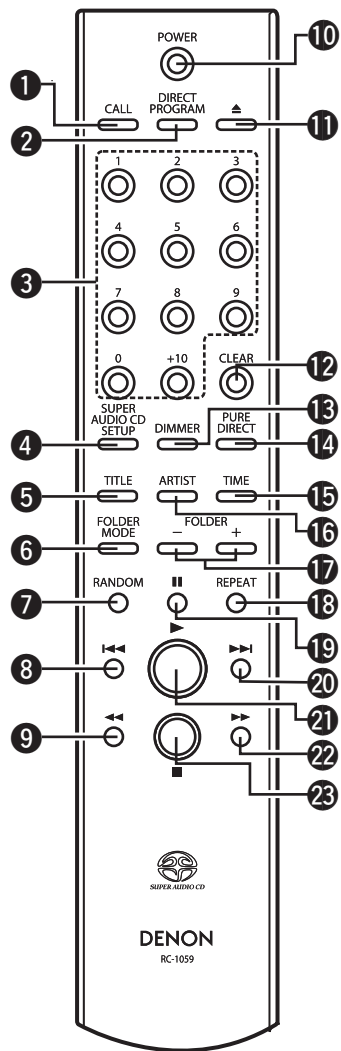

- 1 CALL button (10)
- 2 DIRECT/PROGRAM button (10)
- 3 Number buttons (0 ~ 9, +10) (9)
- 4 SUPER AUDIO CD SETUP button (8, 9)
- 5 TITLE button (10, 12)
- 6 FOLDER MODE button (11, 12)
- 7 RANDOM button (10, 12)
- 8 Skip button (I◀◀) (9, 12)
- 9 Search button (◀◀) (9)
- 10 POWER button (8)
- 11 Disc tray open/close button (▲) (8 ~ 10)
- 12 CLEAR button (10)
- 13 DIMMER button
Switches the brightness of the display.
Bright → Dark
Display off
- ※ The brightness of the DRA-CX3's display changes together with the brightness of the DCD-CX3's display.
- 14 PURE DIRECT button (9)
- 15 TIME button (9 ~ 12)
- 16 ARTIST button (10, 12)
- 17 FOLDER buttons (12)
- 18 REPEAT button (10, 12)
- 19 Pause button (II) (9)
- 20 Skip button (▶▶I) (9, 12)
- 21 Play button (▶) (9, 10, 12)
- 22 Search button (▶▶) (9)
- 23 Stop button (■) (9)



- The skip buttons (I◀◀ and ▶▶I) and +10 button operate continuously when held in.
- The **POWER**, **PURE DIRECT** and **DIMMER** buttons function for the DENON DRA-CX3 stereo receiver as well, so the DRA-CX3 can be operated simultaneously with the DCD-CX3. When the two units have different settings, press and hold in the button for at least 2 seconds to reset them both to the default setting, then make the desired setting.
- The default settings are "on" for the power, "bright" for the dimmer and "off" for the pure direct mode.





Connections

NOTE

- Do not plug in the power cord until all connections have been completed.
- When making connections, also refer to the operating instructions of the other components.
- Be sure to connect the left and right channels properly (left with left, right with right).
- Do not bundle power cords together with connection cables. Doing so can result in humming or noise.

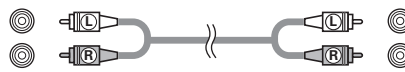
Cable Indications

Connect using the connection cables shown below.

| Audio cables | Signal direction |
|---|--|
| <p>Analog connections</p>  <p>RCA pin-plug cable</p> | <p>Audio signal:</p>  |
| <p>Digital connections (Coaxial)</p> <p>(Orange) </p> <p>Coaxial cable (75 Ω/ohms pin-plug cable)</p> | |
| <p>Digital connections (Optical)</p>  <p>Optical fiber cable</p> | |

Getting Started
Connections
Operations
Troubleshooting
Specifications

Analog Connections

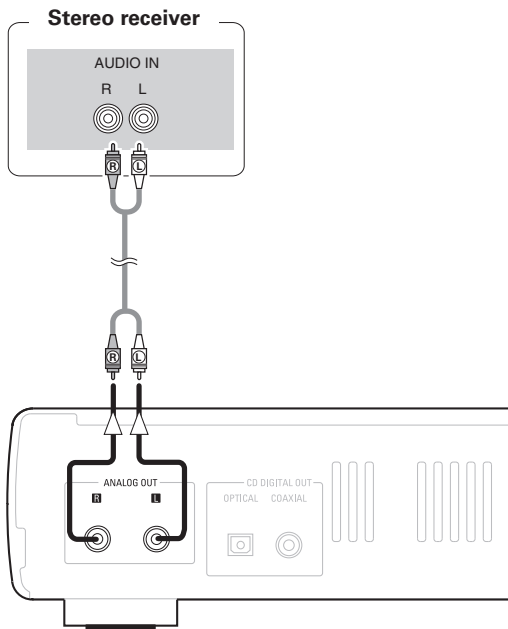

Digital Connections

- Connect either the “COAXIAL” or the “OPTICAL” digital output terminal.
- There is a protective cap covering the optical digital output terminal. After removing the protective cap, insert the plug firmly until it locks.

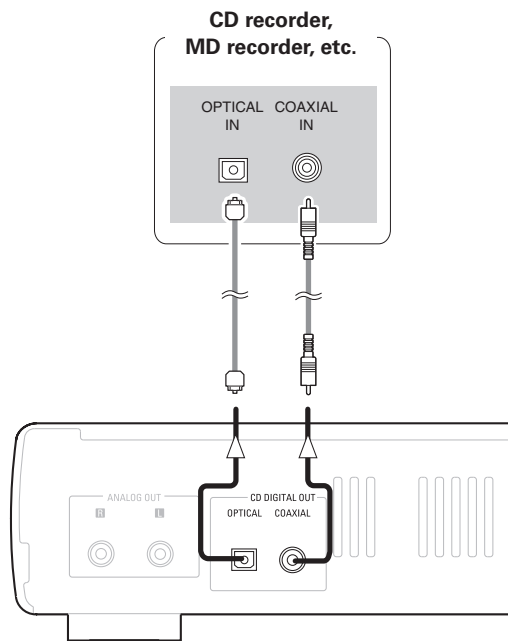

No digital signals are output for Super Audio CDs.

- ❑ **When connecting the optical digital output connector with an optical transmission cable (commercially available)**

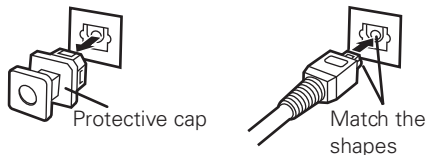

Remove the protective cap, match the shapes, then insert firmly all the way in.



Store the protective cap in a safe place so as not to lose it, and use it when not using the terminal.

Connecting the Power Cord

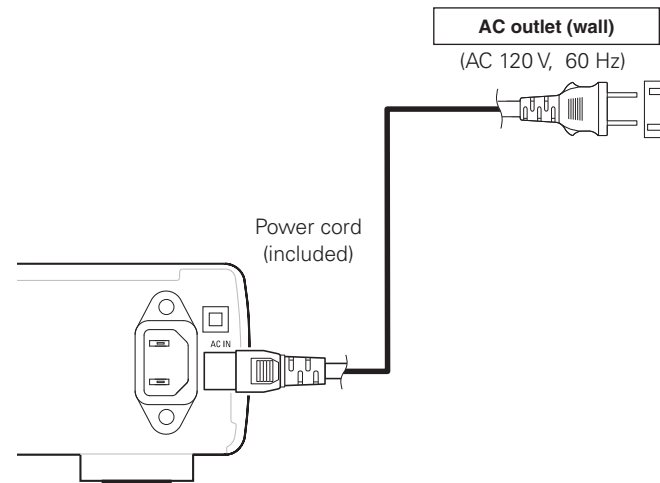

NOTE

- Insert the plugs securely. Incomplete connections will result in the generation of noise.
- Do not unplug the power cord while the set is operating.

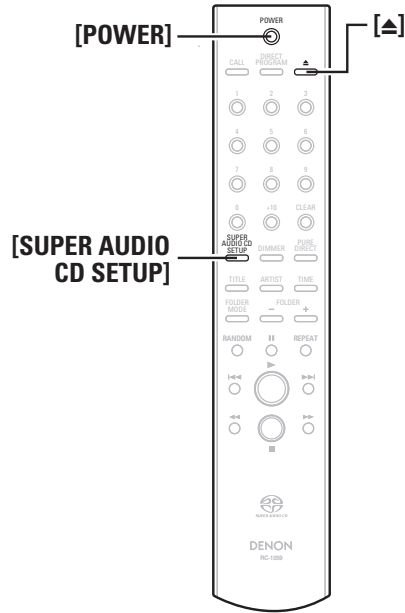
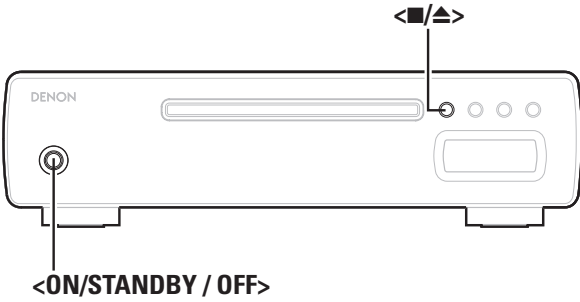

Operations

Before Playing

Turning the Power On

Press **<ON/STANDBY / OFF>**.

- When a disc is loaded, playback starts automatically.
- When no disc is loaded, "NO DISC" is displayed.

Setting the power to the standby mode:

Press **[POWER]**.

Canceling the standby mode:

Press **[POWER]** again.

Turning the power off:

Press **<ON/STANDBY / OFF>** again.



Power indicator

Power on Red **Standby** Orange

NOTE

Be sure to stop playback before turning the power off.

Setting the Layer to be Played with Priority

- The layer that is played with priority when the disc is loaded can be set.
- Upon purchase, the priority layer is set to the "SA-CD"

With "NO DISC" displayed, press **[SUPER AUDIO CD SETUP]** to switch the layer.

SA-CD ↔ CD

SA-CD:

The SA-CD layer mode for Super Audio CDs

CD:

The CD layer mode for Super Audio CDs



- This setting is stored in the DCD-CX3's memory and is not canceled even when the disc tray is opened or closed or the power is turned on or off. To change the setting, perform the above procedure again.
- The priority layer cannot be set when a disc is loaded or when "OPEN" is displayed.

Loading Discs

In the stop mode, press **<■/▲>** or **[▲]** to open the disc tray.

To close the disc tray:

Press **<■/▲>** again or press **[▲]**.

NOTE

- The power must be on when opening and closing the disc tray.
- Do not push the disc tray in by hand when the power is off. Doing so can damage it.
- Do not insert foreign objects into the disc tray. Doing so will damage it.

About the button names in these explanations

< > : Buttons on the main unit

[] : Buttons on the remote control unit

Button name only:

Buttons on the main unit and remote control unit

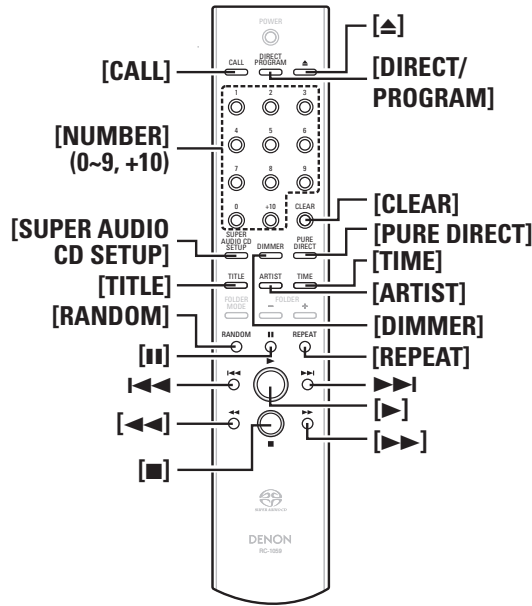
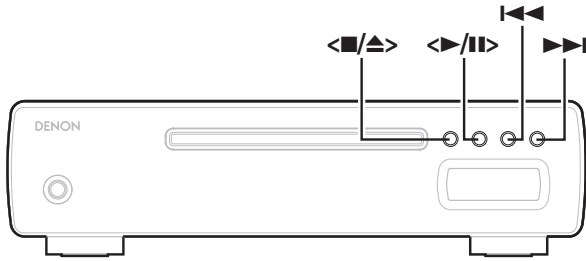

About the button names in these explanations
 < > : Buttons on the main unit
 [] : Buttons on the remote control unit
Button name only:
 Buttons on the main unit and remote control unit

Playing Discs with Even Higher Sound Quality (Pure Direct Mode)

Press **[PURE DIRECT]**.

- The digital output is turned off.
- The display is turned off.

(Some indicators are displayed when nothing is being played and when no disc is loaded.)

[DIMMER] does not function when in the pure direct mode.

Canceling the Pure Direct mode:
 Press **[PURE DIRECT]** again.

Normal Playback

1 For Super Audio CDs:
 If necessary, press **[SUPER AUDIO CD SETUP]** to switch the playback layer.

※ It is not possible to switch to a layer not recorded on the disc.

2 Press <>/||> or [▶].
 • The “▶” indicator lights and playback starts.

※ Once all the tracks on the disc have been played, the stop mode is set.

※ **[TIME]** can be used to switch the information displayed.

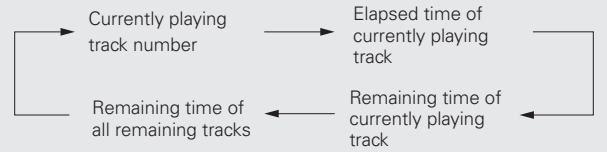

※ In the stop mode, the display switches between the total number of tracks and the total time.

Stopping playback:
 Press <|/> or [■].

Stopping playback temporarily:
 Press <>/||> or [||].

※ To resume playback, press <>/||> or [▶].

Fast-forwarding and fast-reversing (searching):
 During playback, press and hold in [▶▶] or [◀◀].

• Normal playback resumes when the button is released.
 • The sound may be interrupted for a brief moment when resuming normal playback after searching.

Moving to the beginning of tracks (skipping):
 Press [▶▶] or [◀◀] during playback.

※ The operation is as follows if the button is held in:
 ▶▶: Repeated skipping to the beginning of subsequent tracks
 ◀◀: Repeated skipping to the beginning of previous tracks

Finding tracks directly:
 Press **[NUMBER]** (0 ~ 9, +10) to select the track.

※ For track numbers 1 to 9, press the corresponding button ([1] to [9]).
 For track numbers 10 and on, first press **[+10]** then press buttons [0] to [9].

Example: Track 4 : [4]
Example: Track 12 : [+10] [2]
Example: Track 20 : [+10] [+10] [0]

Various Types of Playback

Listening to Specific Tracks in a Specific Order (Programmed Playback)

Up to 20 tracks can be programmed.

1 In the stop mode, press [DIRECT/PROGRAM].
 The “PROG” indicator lights.

2 Press [NUMBER] (0 ~ 9, +10) to select the tracks.
Example: To program tracks 3, 12, 7 to play in that order:
 [3] [+10] [2] [7]

3 Press <>/||> or [▶].
 The tracks are played in the programmed order.

❑ Checking the order of the programmed tracks:

- In the stop mode, press [CALL] repeatedly.
- The track numbers are displayed in the programmed order.

※ The total time of the tracks can be checked by pressing [TIME].

❑ Clearing the last programmed track:

In the stop mode, press [CLEAR].

❑ Clearing all the programmed tracks:

- ① In the stop mode, press [DIRECT/PROGRAM].
- ② Press <■/▲> or [▲] to open the disc tray.



- Direct searching is not possible during programmed playback.
- "--:--" is displayed if the total programmed time exceeds 99 minutes, 59 seconds.
- Programmed playback is not possible with MP3 and WMA files.

Listening in Random Order (Random Playback)

1 In the stop mode, press [RANDOM].

The "RND" indicator lights.

2 Press <▶/||> or [▶].

- During normal playback:
Tracks are selected and played automatically in random order.
- In the 1-track repeat mode:
A track is selected automatically and that track is played repeatedly.
- During the all-track repeat mode:
All the tracks are played once in random order, then played again repeatedly, each time in a different random order.

❑ Canceling random playback:

In the stop mode, press [RANDOM].



Direct searching is not possible during random playback.

Listening to Tracks Repeatedly (Repeat Playback)

Listening to a specific track repeatedly (1-track repeat playback)

During playback, press [REPEAT] once.

The "C D 1" indicator lights and that track is played repeatedly.

❑ Canceling 1-track repeat playback:

- ① Press [REPEAT] twice.
- ② Press <■/▲> or [▲] to open the disc tray.



In the stop mode, the 1-track repeat mode can be set by pressing [REPEAT] once. Press <▶/||> or [▶] to start playback.

Listening to all the tracks repeatedly (All-track repeat playback)

1 Press [REPEAT] twice.

The "C D ALL" indicator lights.

2 Press <▶/||> or [▶].

- During normal playback:
All the tracks are played repeatedly.
- In the random playback mode:
The tracks are played once each in random order, then played again in a different order.

❑ Canceling all-track repeat playback:

- ① Press [REPEAT] again.
- ② Press <■/▲> or [▲] to open the disc tray.

Displaying Text (Super Audio CDs only)

When a Super Audio CD containing text is loaded, the text data recorded on the disc (album title, artist name and track title) can be displayed in the stop or play mode.

Displaying the Track Title

Press [TITLE] during playback.

※ If the track switches while the title is displayed, the title of the new track is displayed.

Displaying the Album Title

In the stop mode, press [TITLE].

Displaying the Album's Artist Name

In the stop mode, press [ARTIST].

❑ Switching the display to the total recorded time while text data is displayed:

Press [TIME].



If a disc not containing text data is loaded, "NO TEXT" is displayed when [TITLE] or [ARTIST] is pressed.

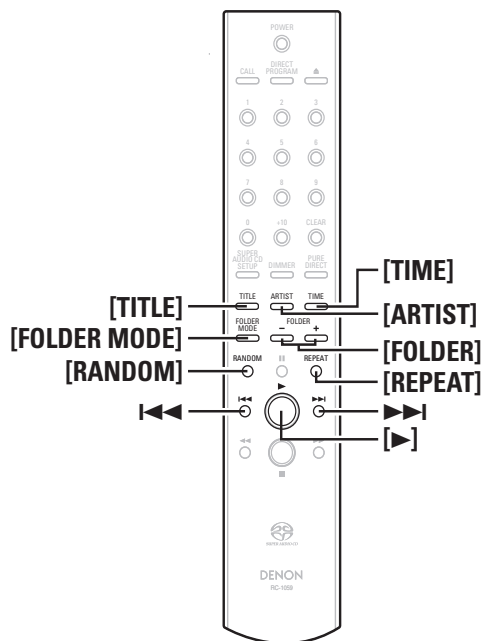
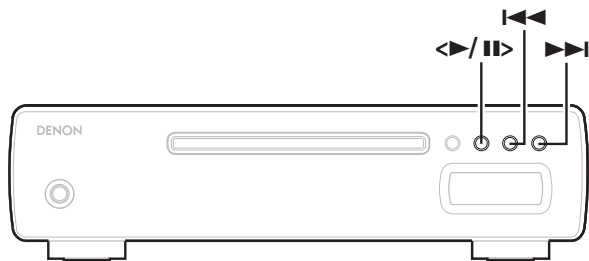

Playing Music files

Before Playing MP3 or WMA files

There are many music distribution sites on the Internet allowing you to download music files in MP3 or WMA (Windows Media® Audio) format. The music (files) downloaded from such sites can be stored on CD-R or CD-RW discs and played on the DCD-CX3.

※ “Windows Media” and “Windows” are registered trademarks or trademarks in the United States and other countries of Microsoft Corporation of the United States.

Creating MP3 and WMA files Compatible with the DCD-CX3

- When writing MP3 or WMA files on a CD-R or CD-RW disc, set the writing software’s format to “ISO9660 Level 1”. The files may not play properly if they are recorded in other formats.
- The maximum number of files and folders that can be played is 1000 (total of the number of folders and files). The maximum number of folders is 255.
- The DCD-CX3 is not compatible with packet write software or playlists.
- Also refer to the instructions of the software used to create the MP3 or WMA files.
- Be sure to give the extension “MP3” or “WMA” to the MP3 or WMA files. Files with other extensions or with no extensions cannot be played.

※ According to copyright laws, recordings you have made should only be used for your personal enjoyment and must not be used in other ways without the consent of the copyright holder.

[Playable MP3 and WMA files]

| File format | Sampling frequency (kHz) | Bit rate (kbps) | Extension |
|-------------|--------------------------|-----------------|-----------|
| MP3 | 32, 44.1, 48 | 32 ~ 320 | .MP3 |
| WMA | 32, 44.1, 48 | 64 ~ 160 | .WMA |

- The DCD-CX3 is compatible with the “MPEG-1 Audio Layer-3” standards. It is not compatible with the “MPEG-2 Audio Layer-3”, “MPEG-2.5 Audio Layer-3”, “MP1”, “MP2” or “MP3 PRO” standards.
- The DCD-CX3 is not compatible with ID3-Tag or meta-tag technology.
- When playing MP3 and WMA files, the digital output is converted to PCM. The signals are output with the same sampling frequency as when they were written.
- With the DCD-CX3, the folder and file names can be displayed like titles. Up to 8 characters consisting of numbers, letters and the underscore can be displayed. Characters that cannot be displayed are replaced with asterisks.
- Copyright-protected files cannot be played. Note that depending on the software used for burning and other conditions, some files may not play or display correctly.
- The positions of the folders or files may have been changed by the writing software when burning the MP3/WMA files onto the CD-R/CD-RW disc, so the files may not play in the expected order.
- JPEG and DivX® files are handled as files but cannot be played.

Folder mode and disc mode settings:

Press **[FOLDER MODE]** to switch the range of the files to be played.

• Folder mode

The “WMA” or “MP3” indicator flashes.
The files in the selected folder are played.

• Disc mode

The “WMA” or “MP3” indicator lights.
All the files on the disc are played.

About the button names in these explanations

- < > : Buttons on the main unit
- [] : Buttons on the remote control unit

Button name only:

Buttons on the main unit and remote control unit

Playing MP3 or WMA files

1 Load a CD-R or CD-RW disc containing music files in the MP3 or WMA format into the disc tray (☞ page 2).

2 Press **[FOLDER MODE]** to select the folder mode or disc mode.

※ Refer to "Folder mode and disc mode settings".

3 Press **<▶/||>** or **[▶]**.
Playback starts.

※ The file name or folder name can be displayed by pressing **[TITLE]** or **[ARTIST]**.



※ **[TIME]** can be used to switch the information displayed.

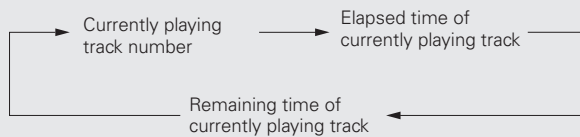

※ In the stop mode, only the total number of tracks is displayed.

Changing the folder to be played:

Press **[FOLDER]** and select the desired folder.

Changing the file to be played:

Press **◀◀** or **▶▶** to select the desired file.



When a folder is selected, playback switches to the first track of the selected folder.

Listening to MP3 or WMA files in Random Order (Random Playback)

1 Press **[FOLDER MODE]** to select the disc mode.

※ Refer to "Folder mode and disc mode settings" (☞ page 11).

2 Press **[RANDOM]**.
The "RND" indicator lights.

3 Press **<▶/||>** or **[▶]**.
Tracks are selected and played automatically in random order.

Canceling random playback:

In the stop mode, press **[RANDOM]**.

- The "RND" indicator turns off.



Random playback is not possible in the folder mode.

Listening to MP3 or WMA files Repeatedly (Repeat Folder/Disc Playback)

1 Press **[FOLDER MODE]** to select the folder mode or disc mode.

※ Refer to "Folder mode and disc mode settings" (☞ page 11).

2 Press **[REPEAT]** to select the repeat mode.

※ Using the folder mode:



※ Using the disc mode:

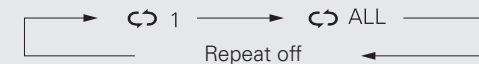

3 Press **<▶/||>** or **[▶]**.
Either the files in the selected folder or all the files on the disc are played repeatedly.

Canceling repeat folder/disc playback:

Press **[REPEAT]** until the "↻" indicator turns off.

Using the Timer Play Function

Also refer to the operating instructions of the audio timer.

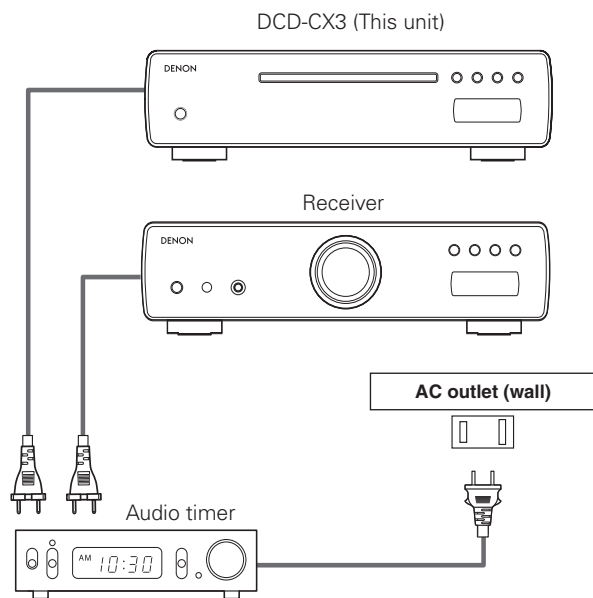

1 Turn on the power of the connected components.

2 Switch the receiver's input function to the function to which the player is connected.

3 Load a disc in the player.

4 Set the audio timer for the desired times.

5 Turn the timer "ON".

The power of the components connected to the timer turns off.

※ When the set time is reached, the power of the different components automatically turns on and playback starts from the first track.

Troubleshooting

If a problem should arise, first check the following:

1. Are the connections correct ?
2. Is the set being operated as described in the operating instructions ?
3. Are the other components operating properly ?

If this unit does not operate properly, check the items listed in the table below. Should the problem persist, there may be a malfunction. In this case, disconnect the power immediately and contact your store of purchase.

| Symptom | Cause | Measures | Page |
|---|--|---|--------|
| Disc tray does not open. | • The power is not on. | • Turn on the power. | 8 |
| "NO DISC" is displayed even though a disc is loaded. | • The disc is not properly loaded. | • Reload the disc. | 3 |
| "00 : 00" is displayed even though a disc is loaded. | • A disc other than a CD or Super Audio CD is loaded. | • Load a CD or Super Audio CD. | 3 |
| Playback does not start even when the ►/ button on the main unit or the ► button on the remote control unit is pressed. | • The disc is dirty or scratched. | • Wipe the dirt off the disc or replace the disc. | 3 |
| No sound is produced or sound is distorted. | • The output cables are not properly connected to the receiver. • The receiver's function setting or adjustments are not right. | • Check the connections. • Check the receiver's function and controls and adjust as necessary. | 7 - |
| No digital signals are output. | • For Super Audio CDs, no digital signals are output. • Turn the pure direct mode on. | • For Super Audio CDs, use the analog audio output signals. • Turn the pure direct mode off. | 7 9 |
| A specific section of the disc cannot be played properly. | • The disc is dirty or scratched. | • Wipe the dirt off the disc or replace the disc. | 3 |
| Programmed playback is not possible. | • The tracks have not been programmed properly. | • Program properly. | 9, 10 |
| A CD-R or CD-RW disc cannot be played. | • The disc has not been finalized. • The recording conditions are bad or the quality of the disc itself is poor. | • Finalize the disc then play it. • Use a properly recorded disc. | 2 2 |
| Files recorded in MP3 or WMA format cannot be played. | • You have selected a copyright-protected WMA file or a file that cannot be played normally. | • Press the ◀◀ or ▶▶ button to select a different file. | 11 |
| Set does not operate properly when remote control unit is operated. | • The batteries are spent. • The remote control unit is too far from the set. | • Replace the batteries with new ones. • Move the remote control unit closer to the set. | 4 4 |

Specifications

| | [Super Audio CD] | [CD] |
|---|--|-------------------------|
| <input type="checkbox"/> Audio performance | | |
| • Analog output | | |
| Channels: | 2 channels | 2 channels |
| Playable frequency range: | 2 Hz ~ 100 kHz | 2 Hz ~ 20 kHz |
| Playback frequency response: | 2 Hz ~ 50 kHz (-3 dB) | 2 Hz ~ 20 kHz |
| S/N: | 112 dB (Audible range) | 118 dB |
| Dynamic range: | 109 dB (Audible range) | 100 dB |
| Harmonic distortion: | 0.0007 % (1 kHz, Audible range) | 0.0017 % (1 kHz) |
| Wow & flutter: | Below measurable limits | Below measurable limits |
| Output level: | 2.0 V (10 kΩ/kohms) | 2.0 V (10 kΩ/kohms) |
| • Digital output | | |
| Coaxial: | - | 0.5 Vp-p / 75 Ω/ohms |
| Optical: | - | -15 ~ -21 dBm |
| Emission wavelength: | - | 660 nm |
| <input type="checkbox"/> Signal type: | 1-bit DSD | 16-bit linear PCM |
| <input type="checkbox"/> Sampling frequency: | 2.822 MHz | 44.1 kHz |
| <input type="checkbox"/> Usable discs: | Super Audio CD | Compact Disc |
| <input type="checkbox"/> General | | |
| Power supply: | AC 120 V, 60 Hz | |
| Power consumption: | 26 W | |
| | Standby: 0.2 W or less | |
| Maximum external dimensions: | 300 (W) x 80 (H) x 310 (D) mm (11-13/16" x 3-3/16" x 13-7/16") | |
| Weight: | 7.0 kg (15 lbs 7 oz) | |
| <input type="checkbox"/> Remote control unit (RC-1059) | | |
| Remote control method: | Infrared pulse method | |
| Batteries: | R03/AAA Type (two batteries) | |
| Maximum external dimensions: | 44 (W) x 233 (H) x 22 (D) mm (1-3/4" x 9-3/16" x 7/8") | |
| Weight: | 165 g (5.8 oz) (including batteries) | |

※ For purposes of improvement, specifications and design are subject to change without notice



DENON

www.denon.com

Denon Brand Company, D&M Holdings Inc.
Printed in Japan 5411 10026 004D

Free Manuals Download Website

<http://myh66.com>

<http://usermanuals.us>

<http://www.somanuals.com>

<http://www.4manuals.cc>

<http://www.manual-lib.com>

<http://www.404manual.com>

<http://www.luxmanual.com>

<http://aubethermostatmanual.com>

Golf course search by state

<http://golfingnear.com>

Email search by domain

<http://emailbydomain.com>

Auto manuals search

<http://auto.somanuals.com>

TV manuals search

<http://tv.somanuals.com>