

DENON

DVD VIDEO AUTO CHANGER

DVM-1845

OPERATING INSTRUCTIONS

MODE D'EMPLOI

INSTRUCCIONES DE FUNCIONAMIENTO

WARNING: TO REDUCE THE RISK OF FIRE OR ELECTRIC SHOCK, DO NOT EXPOSE THIS APPLIANCE TO RAIN OR MOISTURE.



CAUTION
RISK OF ELECTRIC SHOCK
DO NOT OPEN



CAUTION:

TO REDUCE THE RISK OF ELECTRIC SHOCK, DO NOT REMOVE COVER (OR BACK). NO USER SERVICEABLE PARTS INSIDE. REFER SERVICING TO QUALIFIED SERVICE PERSONNEL.



The lightning flash with arrowhead symbol, within an equilateral triangle, is intended to alert the user to the presence of uninsulated "dangerous voltage" within the product's enclosure that may be of sufficient magnitude to constitute a risk of electric shock to persons.



The exclamation point within an equilateral triangle is intended to alert the user to the presence of important operating and maintenance (servicing) instructions in the literature accompanying the appliance.

The caution marking is located on the rear of the cabinet.

IMPORTANT SAFEGUARDS

- 1) Read Instructions - All the safety and operating instructions should be read before the product is operated.
- 2) Retain Instructions - The safety and operating instructions should be retained for future reference.
- 3) Heed Warnings - All warnings on the product and in the operating instructions should be adhered to.
- 4) Follow Instructions - All operating and use instructions should be followed.
- 5) Cleaning - Unplug this product from the wall outlet before cleaning. Do not use liquid cleaners or aerosol cleaners. Use a damp cloth for cleaning.
- 6) Attachments - Do not use attachments not recommended by the product manufacturer as they may cause hazards.
- 7) Water and Moisture - Do not use this product near water - for example, near a bath tub, wash bowl, kitchen sink, or laundry tub; in a wet basement; or near a swimming pool; and the like.
- 8) Accessories - Do not place this product on an unstable cart, stand, tripod, bracket, or table. The product may fall, causing serious injury to a child or adult, and serious damage to the product. Use only with a cart, stand, tripod, bracket, or table recommended by the manufacturer, or sold with the product. Any mounting of the product should follow the manufacturer's instructions, and should use a mounting accessory recommended by the manufacturer.
- 9) A product and cart combination should be moved with care. Quick stops, excessive force, and uneven surfaces may cause the product and cart combination to overturn.
- 10) Ventilation - Slots and openings in the cabinet are provided for ventilation and to ensure reliable operation of the product and to protect it from overheating, and these openings must not be blocked or covered. The openings should never be blocked by placing the product on a bed, sofa, rug, or other similar surface. This product should not be placed in a built-in installation such as a bookcase or rack unless proper ventilation is provided or the manufacturer's instructions have been adhered to.
- 11) Power Sources - This product should be operated only from the type of power source indicated on the marking label. If you are not sure of the type of power supply to your home, consult your product dealer or local power company. For products intended to operate from battery power, or other sources, refer to the operating instructions.
- 12) Grounding or Polarization - This product may be equipped with a polarized alternating-current line plug (a plug having one blade wider than the other). This plug will fit into the power outlet only one way. This is a safety feature. If you are unable to insert the plug fully into the outlet, try reversing the plug. If the plug should still fail to fit, contact your electrician to replace your obsolete outlet. Do not defeat the safety purpose of the polarized plug.
- 13) Power-Cord Protection - Power-supply cords should be routed so that they are not likely to be walked on or pinched by items placed upon or against them, paying particular attention to cords at plugs, convenience receptacles, and the point where they exit from the product.
- 14) Lightning - For added protection for this product during a lightning storm, or when it is left unattended and unused for long periods of time, unplug it from the wall outlet. This will prevent damage to the product due to lightning and power-line surges.
- 15) Power lines - An outside antenna system should not be located in the vicinity of overhead power lines or other electric light or power circuits, or where it can fall into such power lines or circuits. When installing an outside antenna system, extreme care should be taken to keep from touching such power lines or circuits as contact with them might be fatal.
- 16) Overloading - Do not overload wall outlets, extension cords, or integral convenience receptacles as this can result in a risk of fire or electric shock.
- 17) Object and Liquid Entry - Never push objects of any kind into this product through openings as they may touch dangerous voltage points or short-out parts that could result in a fire or electric shock. Never spill liquid of any kind on the product.
- 18) Servicing - Do not attempt to service this product yourself as opening or removing covers may expose you to dangerous voltage or other hazards. Refer all servicing to qualified service personnel.
- 19) Damage Requiring Service - Unplug this product from the wall outlet and refer servicing to qualified service personnel under the following conditions:
 - a) When the power-supply cord or plug is damaged.
 - b) If liquid has been spilled, or objects have fallen into the product.
 - c) If the product has been exposed to rain or water.
 - d) If the product does not operate normally by following the operating instructions. Adjust only those controls that are covered by the operating instructions as an improper adjustment of other controls may result in damage and will often require extensive work by a qualified technician to restore the product to its normal operation.
 - e) If the product has been dropped or damaged in any way.
 - f) When the product exhibits a distinct change in performance - this indicates a need for service.
- 20) Replacement Parts - When replacement parts are required, be sure the service technician has used replacement parts specified by the manufacturer or have the same characteristics as the original part. Unauthorized substitutions may result in fire, electric shock, or other hazards.
- 21) Safety Check - Upon completion of any service or repairs to this product, ask the service technician to perform safety checks to determine that the product is in proper operating condition.
- 22) Heat - The product should be situated away from heat sources such as radiators, heat registers, stoves, or other products (including amplifiers) that produce heat.

PORTABLE CART WARNING
(Symbol provided by RETAC)



S3125A

PRECAUTIONS

Laser Safety

This unit employs a laser. Only a qualified service person should remove the cover or attempt to service this device, due to possible eye injury.

- CAUTION:** USE OF CONTROLS OR ADJUSTMENTS OR PERFORMANCE OF PROCEDURES OTHER THAN THOSE SPECIFIED HEREIN MAY RESULT IN HAZARDOUS RADIATION EXPOSURE.
- CAUTION:** VISIBLE AND INVISIBLE LASER RADIATION WHEN OPEN AND INTERLOCK DEFEATED. DO NOT STARE INTO BEAM.
- LOCATION:** INSIDE, NEAR THE DECK MECHANISM.

FCC WARNING- This equipment may generate or use radio frequency energy. Changes or modifications to this equipment may cause harmful interference unless the modifications are expressly approved in the manual. The user could lose the authority to operate this equipment if an unauthorized change or modification is made.

RADIO-TV INTERFERENCE

This equipment has been tested and found to comply with the limits for a Class B digital device, pursuant to Part 15 of the FCC Rules. These limits are designed to provide reasonable protection against harmful interference in a residential installation. This equipment generates, uses, and can radiate radio frequency energy and, if not installed and used in accordance with the instructions, may cause harmful interference to radio communications. However, there is no guarantee that interference will not occur in a particular installation. If this equipment does cause harmful interference to radio or television reception, which can be determined by turning the equipment off and on, the user is encouraged to try to correct the interference by one or more of the following measures:

- 1) Reorient or relocate the receiving antenna.
- 2) Increase the separation between the equipment and receiver.
- 3) Connect the equipment into an outlet on a circuit different from that to which the receiver is connected.
- 4) Consult the dealer or an experienced radio/TV technician for help.

This Class B digital apparatus complies with Canadian ICES-003.

CAUTION: TO PREVENT ELECTRIC SHOCK, MATCH WIDE BLADE OF PLUG TO WIDE SLOT, FULLY INSERT.

Non-use periods - Turn off the unit when it is not in use. Unplug the unit from the household AC outlet if it is not to be used for a long time. Unplug the unit during lightning storms.

Please read this operating instructions carefully before using your DVD player, and keep it for future reference.

Important

Use only discs marked with logos listed on page 6.

Power Supply

The main power supply is engaged when the main plug is plugged in a 120V, 60Hz AC outlet. To operate the unit, press the **ON/STANDBY** button to turn on the unit.

Warning

To avoid fire or electric shock, do not expose this unit to rain or moisture.

WARNING:
LIVE PARTS INSIDE.
DO NOT REMOVE ANY SCREWS.

Installation Location

For safety and optimum performance of this unit:

- Do not stand the unit up vertically. Install the unit in a horizontal and stable position. Do not place anything directly on top of the unit. Do not place the unit directly on top of the TV.
- Shield it from direct sunlight and keep it away from sources of intense heat. Avoid dusty or humid places. Avoid places with insufficient ventilation for proper heat dissipation. Do not block the ventilation holes on the sides of the unit. Avoid locations subject to strong vibration or strong magnetic fields.
- Be sure to remove a disc and unplug the AC power cord from the outlet before carrying the unit.

Cautions on Installation

Noise or disturbance of the picture may be generated if this unit or any other electronic equipment using microprocessors is used near a tuner or TV.

If this happens, take the following steps:

- Install this unit as far as possible from the tuner or TV.
- Set the antenna wires from the tuner or TV away from this unit's power cord and input/output connection cords.
- Noise or disturbance tends to occur particularly when using indoor antennas or 300Ω/ohms feeder wires. We recommend using outdoor antennas and 75Ω/ohms coaxial cables.

NOTE:

- For heat dispersal, do not install this equipment in a confined space such as a book case or similar unit.

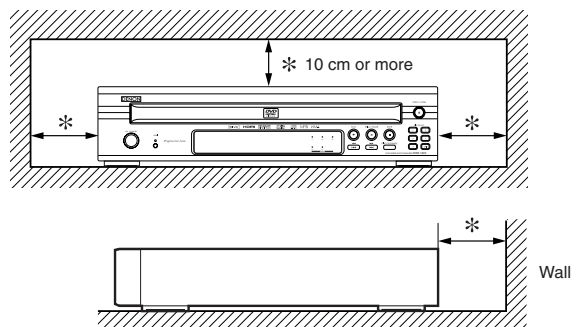

PRECAUTIONS

Dew Warning

Moisture condensation may occur inside the unit when it is moved from a cold place to a warm place, or after heating a cold room or under conditions of high humidity. Do not use the DVD Player at least for 2 hours until its inside is dry.

Avoid the Hazards of Electrical Shock and Fire

- Do not handle the power cord with wet hands.
- Do not pull on the power cord when disconnecting it from AC wall outlet. Grasp it by the plug.
- If, by accident, water is spilled on this unit, unplug the power cord immediately and take the unit to our Authorized Service Center for servicing.

Caution

- 1) Do not attempt to open the cabinet. There are no parts you can service inside. Refer all servicing to qualified service personnel.
- 2) Slot and openings in the cabinet and at the side or bottom are provided for ventilation. To ensure reliable operation and to protect the unit from overheating these opening must not be blocked or covered. Avoid enclosed spaces such as book cases unless proper ventilation is provided.
- 3) Keep the unit away from the radiator heat sources.
- 4) Avoid using near strong magnetic fields.
- 5) Do not push objects of any kind into this through the cabinet slot as they could touch current carrying parts or short circuit parts resulting in a fire or electric shock.
- 6) Never spill liquid of any kind on this unit.
If liquid is spilled into the unit, consult qualified service engineer.
- 7) Use this unit in a horizontal (flat) position only.
- 8) This equipment is in Stand-by mode when it turns off whilst the power cord is connected.
- 9) Keep the set free from moisture, water and dust.
- 10) Sufficiently ventilate the place of installation. If the unit is left in a room full of the smoke from cigarettes, etc., for long periods of time, the surface of the optical pickup could get dirty, in which case it will not be able to read the signals properly.
- 11) Store the operating instructions in a safe place. After reading the operating instructions, store them in a safe place as they could come in handy in the future.
- 12) Handle the power cord carefully. Hold the plug when unplugging the code.
- 13) All the safety cautions and operating instructions should be read before the DVD player is operated.
- 14) Use caution not to pinch your finger in the disc slot.
- 15) Do not put heavy objects on the AC power cord.
- 16) Keep the AC power cord away from heat appliances.
- 17) Be sure to remove a disc and unplug the AC power cord from the outlet before carrying the DVD player.
- 18) Do not put any pressure to the DVD player when carrying.
- 19) Do not use the DVD player outdoors.

TABLE OF CONTENTS

■ IMPORTANT SAFEGUARDS	2	Title / Chapter Search	19
■ PRECAUTIONS	3	By using the SEARCH MODE button	19
Laser Safety	3	By using the SKIP buttons ◀◀ ▶▶	19
Important	3	Track Search	19
Power Supply	3	By using the SEARCH MODE button	19
Warning	3	By using the SKIP buttons ◀◀ ▶▶	19
Installation Location	3	Time Search	19
Cautions on Installation	3	Marker Setup Screen	20
Dew Warning	4	Repeat	20
Avoid the Hazards of Electrical Shock and Fire	4	REPEAT TITLE / CHAPTER	20
Caution	4	REPEAT TRACK / GROUP / DISC	20
■ INTRODUCTION	5	A-B REPEAT	20
About Copyright	5	Program Playback	21
Notice for the Progressive Scan Outputs	5	Random Playback	22
Supplied Accessories	5	MP3 / JPEG / WMA Playback	22
Symbols Used in this Manual	5	DivX® Playback	24
■ ABOUT THE DISCS	6	DivX® Subtitle	24
Playable Discs	6	Changing the On-Screen Display	25
■ FEATURES	7	Slide Show Mode	26
■ FUNCTIONAL OVERVIEW	8	Dialog Speed	26
FRONT PANEL	8	Audio Language	26
REMOTE CONTROL	8	Subtitle Language	27
Tour of the Remote Control	9	Camera Angle	27
Front Panel Display	11	Picture Control	27
Displays During Operation	11	Stereo Sound Mode	28
Loading the Batteries	12	Virtual Surround	28
Using a Remote Control	12	Black Level Setting	28
■ CONNECTIONS	13	■ DVD SETUP	29
Description - Rear Panel	13	Language Setting	29
Connection to an Audio System	14	Display Setting	29
Connection to a TV (for video)	15	Audio Setting	30
Connection to a TV with an HDMI Compatible Port	16	Ratings Control	30
■ DISC PLAYBACK	17	RATING LEVEL	30
Basic Playback	17	IF YOU FORGET THE PASSWORD	30
CANCELING AND CALLING BACK PBC FUNCTION	17	CONTROL LEVELS	30
HDMI Setup	17	Others Setting	31
General Features	17	Reset to the Default Settings (except for Ratings Control)	31
Disc Menus	17	Language Code List	32
Title Menu	18	■ TROUBLESHOOTING GUIDE	33
CALLING UP A MENU SCREEN DURING PLAYBACK	18	■ SPECIFICATIONS	34
Still / Pause	18	■ MAINTENANCE	34
Resume	18		
Fast Forward / Reverse Search	18		
Slow Forward / Slow Reverse	18		
Step by Step Playback	18		
Zoom	19		

INTRODUCTION

The serial number of this product may be found on the back of the DVD player. No others have the same serial number as yours. You should record the number and other vital information here and retain this book as a permanent record of your purchase to aid identification in case of theft. Serial numbers are not kept on file.

Date of Purchase	
Dealer Purchase from	
Dealer Address	
Dealer Phone No.	
Model No.	
Serial No.	

About Copyright

Unauthorized copying, broadcasting, public performance and lending of discs are prohibited. This product incorporates copyright protection technology that is protected by U.S. patents and other intellectual property rights. Use of this copyright protection technology must be authorized by Macrovision, and is intended for home and other limited viewing uses only unless otherwise authorized by Macrovision. Reverse engineering or disassembly is prohibited.





U. S. Patent Nos, 4,631,603, 4,819,098, 4,907,093, 5,315,448 and 6,516,132.

Notice for the Progressive Scan Outputs

Consumers should note that not all high definition television sets are fully compatible with this product and may cause artifacts to be displayed in the picture. In case of picture problems with 525 progressive scan output, it is recommended that the user switch the connection to the 'standard definition' output. If there are questions regarding your TV set compatibility with this 525p DVD player, please contact our customer service center.

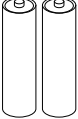
Supplied Accessories

Please check to make sure the following items are included with the main unit in the carton.

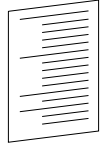
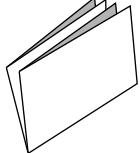
Remote control..... 1 	"AA" (R6P) batteries... 2 	Audio cable..... 1 	Video cable..... 1 	Operating Instructions... 1 	Service Station List..... 1 	Warranty Card..... 1 
--	--	---	---	--	---	---

Symbols Used in this Manual

The following symbols appear below in some headings and notes in this manual, with the following meanings.

DVD-V : Description refers to playback of DVD-Video discs. (including DVD-R/RW discs)

JPEG : Description refers to viewing of JPEG discs.

VCD : Description refers to playback of Video CDs.

WMA : Description refers to playback of discs formatted with WMA.

CD : Description refers to playback of Audio CDs.

DivX® : Description refers to playback of discs formatted with DivX®.

MP3 : Description refers to playback of discs formatted with MP3.

A NOTE ABOUT RECYCLING

This product's packaging materials are recyclable and can be reused. Please dispose of any materials in accordance with your local recycling regulations.

Batteries should never be thrown away or incinerated but disposed of in accordance with your local regulations concerning chemical wastes.



Make your contribution to the environment!!!

- Used up batteries do not belong in the dust bin.
- You can dispose of them at a collection point for used up batteries or special waste. Contact your council for details.

Playable Discs

Playable discs	Mark (logo)	Region code	Recorded signals	Disc size	Disc types
DVD-Video * 1, 2, 3, 5			Digital video (MPEG2)	12 cm or 8 cm	 Example: Title 1, Title 2 Chapter 1, Chapter 2, Chapter 3, Chapter 4, Chapter 1, Chapter 2
DVD-R DVD-RW * 1, 3, 4, 5, 6, 7, 8			DivX®		 Example: Group 1, Group 2 Track 1, Track 2, Track 3, Track 4, Track 5, Track 6 (DVD-R/RW only)
Video CD * 1, 3, 5, 9		—	Digital video with audio	12 cm or 8 cm	 Example: Track 1, Track 2, Track 3, Track 4, Track 5, Track 6
Audio CD * 3, 5		—	Digital audio		
CD-R CD-RW * 3, 4, 5, 7, 8, 10		—	Digital audio MP3 WMA*10 Digital picture (JPEG) DivX®		 Example: Group 1, Group 2 Track 1, Track 2, Track 3, Track 4, Track 5, Track 6
Picture CD * 3, 4, 5, 7, 8		—	JPEG	12 cm	

is a trademark of DVD Format/Logo Licensing Corporation.

is trademark of Eastman Kodak Company.

Windows Media and the Windows logo are trademarks or registered trademarks of Microsoft Corporation in the United States and/or other countries.

DivX, DivX Certified, and associated logos are trademarks of DivX, Inc. and are used under license.

If you cannot play back a disc which bears one of the marks above, check the following notes.

- *1: This unit conforms to the NTSC color system. Discs recorded in other color systems such as PAL cannot be played back.
- *2: Certain DVD discs do not operate as described in this manual due to the intentions of the disc's producers.
- *3: Scratched or stained discs may not be played back.
- *4: Some discs cannot be played back because of incompatible recording conditions, characteristics of the recorder or special properties of discs.
- *5: You can play back discs which bear the marks above. If you use nonstandardized discs, this unit may not play them back. Even if they are played back, the sound or video quality will be compromised.
- *6: Only the discs recorded in the video format and finalized can be played back. Unfinalized discs cannot be played back. Depending on the recording status of a disc, the disc may not be played back at all or normally (the picture or sound may be distorted, etc.).
- *7: If there is too much recordable space left on a disc (the used portion is less than 2 3/16 inches (55mm) across), it may not be played back properly.
- *8: Do not glue paper or put stickers on to the disc. These may damage the disc, and the unit may not read it correctly.
- *9: This unit conforms to ver.1.1 and ver.2.0 of Video CD standard, with PBC function.
 Ver.1.1 (without PBC function): You can enjoy playback picture as well as music CD.
 Ver.2.0 (with PBC function): While using a Video CD with PBC function, "Pbc" appears on the screen and the display.
NOTE: When playing back Video CDs with PBC function, some operations (e.g., track search and repeat tracks) cannot be performed. Cancel PBC function temporarily to perform those operations (refer to page 17).
- *10: This player cannot play back the disc contents protected by Windows Media Digital Rights Management (DRM).

What is PBC? "PBC" stands for Playback Control.
 You can play back interactive software using menu screens. Refer to instructions in the Video CD.

- **NEVER play back the following discs. Otherwise, malfunction may result!**
 DVD-RAM / CD-i / Photo CD / DVD with region codes other than 1 or ALL / DVD-ROM for personal computers / CD-ROM for personal computers
- **On the following disc, the sound MAY NOT be heard.**
 DVD-Audio / Super Audio CD
- *Any other discs without compatibility indications*

NOTES:

- Only the sound recorded on the normal CD layer can be delivered. (Super Audio CD)
- The sound recorded on the high density Super Audio CD layer cannot be delivered. (Super Audio CD)
- Disc with the Video zone can be played. (DVD-Audio)
- Disc only of the Audio zone cannot be played. (DVD-Audio)

CAUTION:

- Use caution not to pinch your finger in the disc slot.
- Be sure to remove a disc and unplug the AC power cord from the outlet before carrying the DVD player.

● **Progressive Scan system**

Unlike conventional interlace scanning, the progressive scan system provides less flickering and images in higher resolution than that of traditional (525i/480i) television signals.

● **Dolby Digital Sound**

By connecting this player to a Multi-Channel Dolby Digital decoder, you can enjoy high-quality Multi-Channel Dolby Digital surround sound as heard in the movie theaters.

● **DTS (Digital Theater System)**

When this player is connected to the DTS decoder, you can enjoy Multi-Channel surround system which reproduces the original sound as truthfully as possible. Multi-Channel surround system is developed by DTS, Inc.

● **HDMI (High Definition Multimedia Interface)**

You can enjoy clearer video output when connecting this player to a display equipment with an HDMI-compatible port.

● **Dialog Speed**

Playback in slightly faster or slower speed while keeping the sound quality as in the normal playback.

Dialog speed is available only on discs recorded in the Dolby Digital format.

● **Still/Fast/Slow/Step playback**

Various playback modes are available including still pictures, fast forward/reverse, slow motion and step frames.

● **Still Mode**

The resolution of pictures while in the still (pause) mode can be adjusted.

● **Random Playback for Audio CD, MP3, JPEG and WMA**

This player can shuffle the playback order of tracks in random order.

● **Program Playback for Audio CD, MP3, JPEG and WMA**

You can program the playback order of tracks in a desired order.

● **DVD menus in a desired language**

You can display DVD menus in a desired language, if available on a DVD.

● **Auto Power Off**

The power turns off automatically if there is no activity at the player or its remote for more than 30 minutes (refer to page 31).

● **Subtitles in a desired language**

You can select a desired language for subtitles if that language is available on the DVD and DivX®.

● **Selecting a camera angle**

You can select a desired camera angle if a disc contains sequences recorded from different angles.

● **Choices for audio language and sound mode**

You can select a desired audio language and sound mode if different languages and modes are available on a disc.

● **Ratings Control (Parental lock)**

You can set the control level to limit playback of discs which may not be suitable for children.

● **Automatic detection of discs**

This player automatically detects if a loaded disc is DVD-Video, Video CD, Audio CD, MP3, JPEG, WMA or DivX®.

● **Playing back an MP3 disc**

You can enjoy MP3 files which are recorded on CD-R/RW.

● **Direct Search**

You can search the desired title, chapter, and track with numeric button during playback or in stop mode.

● **On-screen display**

Information about the current operation can be displayed on a TV screen, allowing you to confirm the currently active functions (such as program playback) using the remote control.

● **Dimmer**

The brightness of the front panel display can be adjusted.

● **Screen Saver**

The screen saver program starts if there is no activity at the player or its remote for more than 5 minutes. The brightness of the display is darkened by 75%. The program is deactivated when there is any activity.

● **Picture Control**

Picture Control adjusts Brightness, Contrast, Color, Gamma Correction and Sharpness of the specific display.

● **Search**

Chapter search: Search for a desired chapter.
 Title search: Search for a desired title.
 Track search: Search for a desired track.
 Time search: Search for a desired time point or a title or a track.

● **Repeat**

Chapter: Repeated playback of a chapter of the disc.
 Title: Repeated playback of a title of the disc.
 Track: Repeated playback of a track of the disc.
 Disc: Repeated playback of the entire disc. (exclude DVD-Video)
 5 Disc: Repeated playback of Audio CD/MP3/JPEG/ WMA discs is possible.
 A-B: Repeated playback of a part between two points. (exclude MP3/JPEG/ WMA discs)
 Group: Repeated playback of a folder of MP3/JPEG/WMA/DivX® disc being played is possible.

● **Zoom**

2-time or 4-time magnified image can be displayed.

● **Marker**

Electric reference points designated by user can be called back.

● **Resume Playback**

User can resume playback from the point at which the playback has been stopped even if the power is turned off.

● **Component Video Out Jacks**

Jacks located on the back of the DVD Player which are used to send high-quality video to a TV via Component Video In Jacks.

● **Bit rate indication**

● **DRC (Dynamic Range Control)**

You can control the range of sound volume.

● **Displaying a JPEG picture**

Kodak Picture CDs can be played back. Still images stored in JPEG format on CD-R/RW can also be played back.

● **Reproducing WMA data**

You can enjoy WMA files which are recorded on CD-R/RW.

● **Reproducing DivX® data**

You can enjoy DivX® files which are recorded on DVD-R/RW or CD-R/RW.

- Official DivX® Certified product
- Plays all versions of DivX® video (including DivX® 6) with standard playback of DivX® media files.

“WMA” (Windows Media Audio) is an audio codec developed by Microsoft® in the United States of America.

FUNCTIONAL OVERVIEW

FRONT PANEL

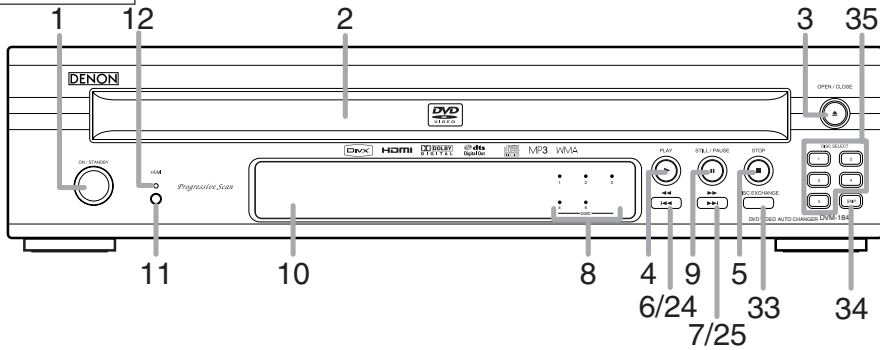

REMOTE CONTROL

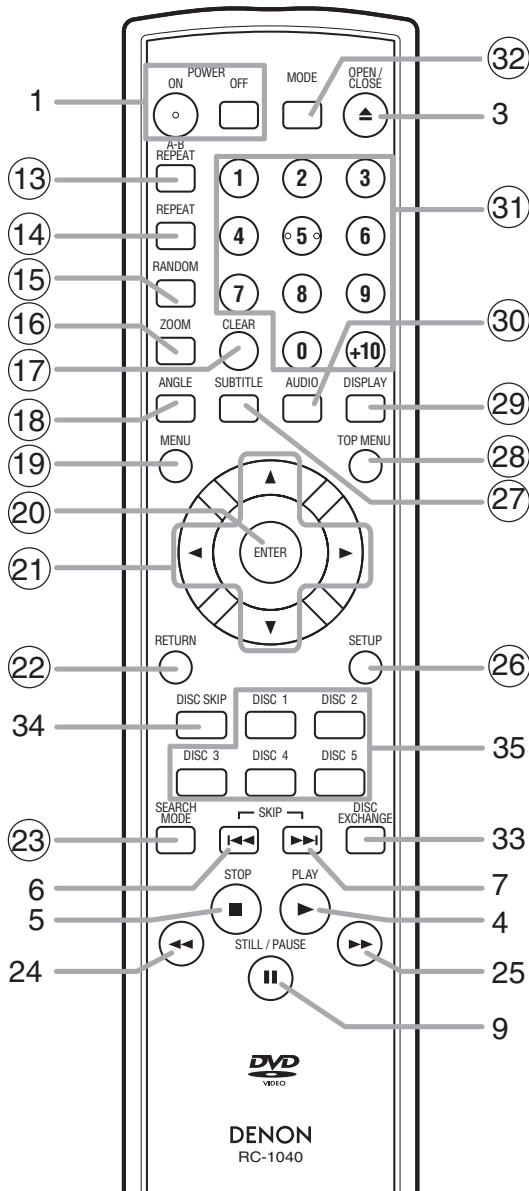









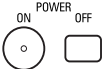

1. **ON/STANDBY (POWER ON/OFF) Buttons** [page 17]
2. **Disc loading tray**
3. **OPEN/CLOSE Button** [page 17]
4. **PLAY Button** [page 17]
5. **STOP Button** [page 17]
6. **◀◀(SKIP DOWN) Button** [page 19]
7. **▶▶(SKIP UP) Button** [page 19]
8. **Disc Indicator**
Green LED indicator lights up when playing discs, Red LED indicator lights up not playing discs. Lights off when discs not into the unit.
9. **STILL/PAUSE Button** [page 18]
10. **Display, Remote Sensor Window**
11. **HDMI Button** [page 17]
Press to set the HDMI connector's video signal output mode.
12. **HDMI indicator** [page 17]
Lights up when there is video signal output from the HDMI OUT jack.
13. **A-B REPEAT Button** [page 20]
14. **REPEAT Button** [page 20]
15. **RANDOM Button** [page 22]
16. **ZOOM Button** [page 19]
17. **CLEAR Button** [page 19]
18. **ANGLE Button** [page 23]
19. **MENU Button** [page 17]
20. **ENTER Button** [page 17]
21. **Cursor Buttons** [page 17]
22. **RETURN Button** [page 18]
23. **SEARCH MODE Button** [page 19]
24. **◀◀(Fast Reverse SEARCH) Button** [page 18]
Press more than 2 seconds when you use the front panel button for this function.
25. **▶▶(Fast Forward SEARCH) Button** [page 18]
Press more than 2 seconds when you use the front panel button for this function.
26. **SETUP Button** [page 29]
27. **SUBTITLE Button** [page 27]
28. **TOP MENU Button** [page 18]
29. **DISPLAY Button** [page 25]
30. **AUDIO Button** [page 26]
31. **Numeric Buttons** [page 17]
32. **MODE Button** [page 21]
33. **DISC EXCHANGE Button** [page 17]
Press to change discs during playback.
34. **DISC SKIP Button** [page 17]
Press to select a desired disc or disc tray.
35. **DISC NUMBER Buttons** [page 17]
Press to select a desired disc or disc tray directly.

The buttons with circled numbers can only be operated with the remote control.

FUNCTIONAL OVERVIEW





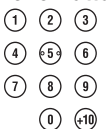









Tour of the Remote Control

Buttons on remote control work in different ways for DVD Video, Video CD, Audio CD, MP3, JPEG, WMA and DivX®. Refer to the following table for correct use.

	DVD-Video	Video CD	CD, MP3, JPEG, WMA	DivX®
POWER ON/OFF Buttons 	<ul style="list-style-type: none"> To turn on or standby the unit. 	<ul style="list-style-type: none"> To turn on or standby the unit. 	<ul style="list-style-type: none"> To turn on or standby the unit. 	<ul style="list-style-type: none"> To turn on or standby the unit.
A-B REPEAT Button 	<ul style="list-style-type: none"> To mark a segment between A and B for repeated playback. 	<ul style="list-style-type: none"> To mark a segment between A and B for repeated playback. 	<ul style="list-style-type: none"> To mark a segment between A and B for repeated playback. (CD) 	<ul style="list-style-type: none"> To mark a segment between A and B for repeated playback.
REPEAT Button 	<ul style="list-style-type: none"> To repeat playback of a title or chapter. 	<ul style="list-style-type: none"> To repeat playback of a track or disc. 	<ul style="list-style-type: none"> To repeat playback of a track or disc. (CD) To repeat playback of a track, group, or disc. (MP3, JPEG, WMA) 	<ul style="list-style-type: none"> To repeat playback of a track, group or disc.
RANDOM Button 	—	—	<ul style="list-style-type: none"> To play back tracks in random order. 	—
MODE Button 	<ul style="list-style-type: none"> To set Picture Control. To set Black level on/off. To activate the 3D sound (Virtual surround system). To set Dialog Speed. 	<ul style="list-style-type: none"> To set Picture Control. To set Black level on/off. To activate the 3D sound (Virtual surround system). 	<ul style="list-style-type: none"> To activate the 3D sound (Virtual surround system). (CD, MP3, WMA) To program a specific playback order. To activate the Slide Show mode. (JPEG) 	<ul style="list-style-type: none"> To set Picture Control. To set Black level on/off.
ZOOM Button 	<ul style="list-style-type: none"> To magnify part of the picture (x2/x4). 	<ul style="list-style-type: none"> To magnify part of the picture (x2). 	<ul style="list-style-type: none"> To magnify part of the picture (x2). (JPEG) 	<ul style="list-style-type: none"> To magnify part of the picture (x2).
ANGLE Button 	<ul style="list-style-type: none"> To access various camera angles on the disc. 	—	<ul style="list-style-type: none"> To rotate a picture. (JPEG) 	—
SUBTITLE Button 	<ul style="list-style-type: none"> To select a subtitle language on the disc. 	—	—	<ul style="list-style-type: none"> To select a subtitle language on the disc.
AUDIO Button 	<ul style="list-style-type: none"> To access various audio functions on the disc. 	<ul style="list-style-type: none"> To select STEREO, L-ch or R-ch. 	<ul style="list-style-type: none"> To select STEREO, L-ch or R-ch. (CD) 	<ul style="list-style-type: none"> To access various audio functions on the disc.
DISPLAY Button 	<ul style="list-style-type: none"> To display the current disc or HDMI mode. 	<ul style="list-style-type: none"> To display the current disc or HDMI mode. 	<ul style="list-style-type: none"> To display the current disc or HDMI mode. 	<ul style="list-style-type: none"> To display the current disc or HDMI mode.
SEARCH MODE Button 	<ul style="list-style-type: none"> To search for a title, chapter, time or marker. 	<ul style="list-style-type: none"> To search for a track, time or marker. 	<ul style="list-style-type: none"> To search for a track. To search for time or a marker. (CD) 	<ul style="list-style-type: none"> To search for a track or time.
OPEN/CLOSE Button 	<ul style="list-style-type: none"> To open or close the disc tray. 	<ul style="list-style-type: none"> To open or close the disc tray. 	<ul style="list-style-type: none"> To open or close the disc tray. 	<ul style="list-style-type: none"> To open or close the disc tray.
Numeric Buttons 	<ul style="list-style-type: none"> To select a title or chapter directly. 	<ul style="list-style-type: none"> To select a track directly. 	<ul style="list-style-type: none"> To select a track directly. 	<ul style="list-style-type: none"> To select a track directly.

FUNCTIONAL OVERVIEW

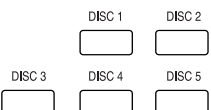
Tour of the Remote Control

	DVD-Video	Video CD	CD, MP3, JPEG, WMA	DivX®
CLEAR Button 	<ul style="list-style-type: none"> To clear the markers. To clear the numbers entered incorrectly. To cancel the A point for A-B Repeat. 	<ul style="list-style-type: none"> To clear the markers. To clear the numbers entered incorrectly. To cancel the A point for A-B Repeat. 	<ul style="list-style-type: none"> To clear the markers. (CD) To clear the numbers entered incorrectly. To cancel the A point for A-B Repeat. (CD) To remove status number in program input. 	<ul style="list-style-type: none"> To clear the numbers entered incorrectly. To cancel the A point for A-B Repeat.
MENU Button 	<ul style="list-style-type: none"> To call up the menu on a disc. 	—	<ul style="list-style-type: none"> To call up the file list. (MP3, JPEG, WMA) 	<ul style="list-style-type: none"> To call up the file list.
TOP MENU Button 	<ul style="list-style-type: none"> To call up the top menu on a disc. 	—	<ul style="list-style-type: none"> To return to the first item in the highest hierarchy of the file list. (MP3, JPEG, WMA) 	<ul style="list-style-type: none"> To return to the top file in the highest hierarchy of the file list.
ENTER, Cursor Buttons 	<ul style="list-style-type: none"> To move the cursor and determine its position. 	<ul style="list-style-type: none"> To move the cursor and determine its position. 	<ul style="list-style-type: none"> To move the cursor and determine its position. 	<ul style="list-style-type: none"> To move the cursor and determine its position.
RETURN Button 	<ul style="list-style-type: none"> To return to the previous operation in the setup menu. 	<ul style="list-style-type: none"> To return to the previous operation in the setup menu. 	<ul style="list-style-type: none"> To return to the previous operation in the setup menu. 	<ul style="list-style-type: none"> To return to the previous operation in the setup menu.
SETUP Button 	<ul style="list-style-type: none"> To call up the setup menu. 	<ul style="list-style-type: none"> To call up the setup menu. 	<ul style="list-style-type: none"> To call up the setup menu. 	<ul style="list-style-type: none"> To call up the setup menu.
SKIP Buttons 	<ul style="list-style-type: none"> To skip titles or chapters. 	<ul style="list-style-type: none"> To skip tracks. 	<ul style="list-style-type: none"> To skip tracks. 	<ul style="list-style-type: none"> To skip tracks.
SEARCH Buttons 	<ul style="list-style-type: none"> To search forward/backward through a disc. To begin slow forward/slow reverse in the pause mode. 	<ul style="list-style-type: none"> To search forward/backward through a disc. To begin slow forward in the pause mode. 	<ul style="list-style-type: none"> To begin fast forward/reverse search. (CD, MP3, WMA) 	<ul style="list-style-type: none"> To search forward/backward through a disc. To begin slow forward in the pause mode.
STOP Button 	<ul style="list-style-type: none"> To stop playback. 	<ul style="list-style-type: none"> To stop playback. 	<ul style="list-style-type: none"> To stop playback. 	<ul style="list-style-type: none"> To stop playback.
PLAY Button 	<ul style="list-style-type: none"> To begin playback. 	<ul style="list-style-type: none"> To begin playback. 	<ul style="list-style-type: none"> To begin playback. 	<ul style="list-style-type: none"> To begin playback.
STILL/PAUSE Button 	<ul style="list-style-type: none"> To pause playback. To advance playback frame by frame. 	<ul style="list-style-type: none"> To pause playback. To advance playback frame by frame. 	<ul style="list-style-type: none"> To pause playback. 	<ul style="list-style-type: none"> To pause playback. To advance playback frame by frame.
DISC SKIP Button 	<ul style="list-style-type: none"> To select a desired disc. 	<ul style="list-style-type: none"> To select a desired disc. 	<ul style="list-style-type: none"> To select a desired disc. 	<ul style="list-style-type: none"> To select a desired disc.
DISC NUMBER Buttons 	<ul style="list-style-type: none"> To select a desired disc directly. 	<ul style="list-style-type: none"> To select a desired disc directly. 	<ul style="list-style-type: none"> To select a desired disc directly. 	<ul style="list-style-type: none"> To select a desired disc directly.
DISC EXCHANGE Button 	<ul style="list-style-type: none"> To change discs during playback. 	<ul style="list-style-type: none"> To change discs during playback. 	<ul style="list-style-type: none"> To change discs during playback. 	<ul style="list-style-type: none"> To change discs during playback.

Front Panel Display

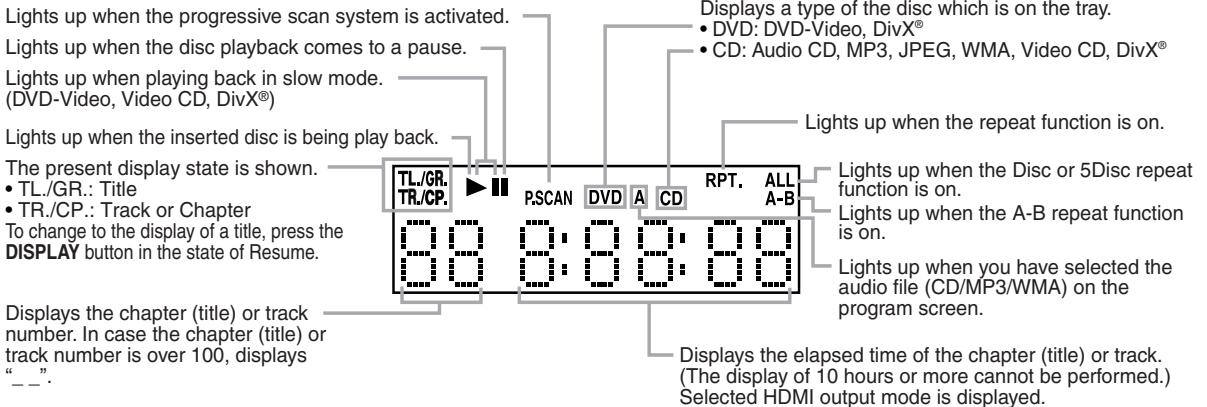

Displays During Operation

	Power on		HDMI output mode (OFF) is selected
	No disc inserted or cannot read		Program playback is set
	Tray open		Program playback setting disc is selected
	Tray closed		Program playback setting group (folder) is selected
	Loading the Disc		Program playback setting ALL CLEAR is selected
	Power off		Random playback is set
	HDMI output mode (480p) is selected		5 Disc random playback is set
	HDMI output mode (720p) is selected		Tray rotation
	HDMI output mode (1080i) is selected		AC cord plugged in
	HDMI output mode (1080p) is selected		

NOTES:

- The front panel display has blinked while setting the program playback.
- “P**●●●” is displayed on the front panel display while setting the program playback. (“**” is program number, “●●●” is track number.)
- “A” is displayed on front panel display while selecting the audio file (CD, MP3, WMA).
- “F-****” is displayed on the front panel display while selecting the group (folder). (“****” is group (folder) number.)
- “A-CLEAR” is displayed on the front panel display while selecting ALL CLEAR.
- “SHUFFLE” is displayed on the front panel display while setting the random playback.
- “5-SHUFF” is displayed on the front panel display while setting the 5 Disc random playback.

Loading the Batteries

1. Open the battery compartment cover.



2. Insert two "AA" (R6P) batteries, with each one oriented correctly.



3. Close the cover.



Cautions On Batteries

- Use "AA" (R6P) batteries in this remote control unit.
- Replace the batteries with new ones approximately once a year, though this depends on the frequency with which the remote control unit is used.
- If the remote control unit does not operate within a close proximity of the main unit, replace the batteries with new ones, even if less than a year has passed.
- The included batteries serve only for verifying operation. Replace them with new batteries as soon as possible.
- When inserting the batteries, be careful to do so in the proper direction, following the ⊕ and ⊖ marks in the remote control unit's battery compartment.
- To prevent damage or battery fluid leakage:
 - Do not mix a new battery with an old one.
 - Do not mix two different types of batteries such as alkaline and manganese.
 - Do not short-circuit, disassemble, heat or dispose of batteries in flames.
- Remove the batteries when not planning to use the remote control unit for a long period of time.
- If the batteries should leak, carefully wipe off the fluid from the inside of the battery compartment, then insert new batteries.

Using a Remote Control

Keep in mind the following when using the remote control:

- Make sure that there are no obstacles between the remote control and the remote sensor on the unit.
- Remote operation may become unreliable if strong sunlight or fluorescent light is shining on the remote sensor of the unit.
- Remote control for different devices can interfere with each other. Avoid using remote control for other equipment located close to the unit.
- Replace the batteries when you notice a fall off in the operating range of the remote control.
- The maximum operable ranges from the unit are as follows.
 - **Line of sight:** approx. 23 feet (7m)
 - **Either side of the center:** approx. 16 feet (5m) within 30°
 - **Above:** approx. 16 feet (5m) within 15°
 - **Below:** approx. 10 feet (3m) within 30°

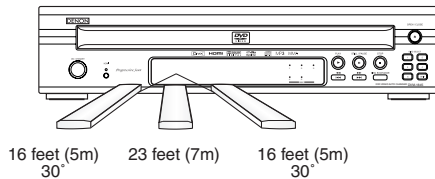

CONNECTIONS

Description - Rear Panel

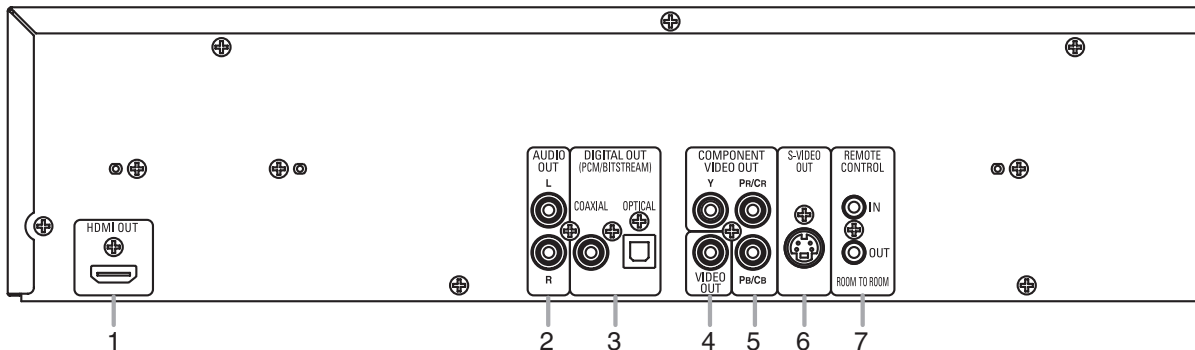

1. HDMI OUT Jack

Use an HDMI connection cable (commercially available) to connect to a display with an HDMI compatible port.

2. AUDIO OUT Jacks

Connect to the Audio input jacks of A/V-compatible TV or wide screen TV, Stereo system.

3. DIGITAL OUT Jacks

Use either an optical or coaxial digital cable (commercially available) to connect to an AV amplifier with a built-in decoder (AV control center).

4. VIDEO OUT Jack

Use a video cable to connect one of the jacks to Video input on your A/V-compatible TV or wide screen TV.

5. COMPONENT VIDEO OUT Jacks

Use a Component Video cable (commercially available) to connect these jacks if you have a TV with Component Video in jacks. These jacks provide C_B/P_B, C_R/P_R and Y video. Along with S-Video, Component Video provides the best quality picture.

6. S-VIDEO OUT Jack

Use the S-Video cable (commercially available) to connect this jack to the S-Video jack on your A/V-compatible TV or wide screen TV for a higher quality picture.

7. REMOTE CONTROL IN/OUT Jacks

Connecting the DENON Satellite Remote Control to these jacks enables you to operate more than one DENON components with one remote control.

When using the DENON Satellite Remote Control,

1. Connect the DENON Satellite Remote Control to the REMOTE CONTROL IN jack of this player. This allows you to operate this player with the Satellite Remote Control.
2. Connect another DENON component to the REMOTE CONTROL OUT jack of this player. This allows you to operate this player and the connected component with the same Satellite Remote Control.

NOTE:

- When there is video output from the HDMI OUT jack, no signal is output from the COMPONENT VIDEO OUT jacks.

Selecting Progressive Scan (525p/480p or Interlaced 525i/480i) Playback

- If your TV is compatible with progressive scanning (525p/480p), connect the TV to the COMPONENT VIDEO OUT jacks of the DVD player and set PROGRESSIVE to ON in the DISPLAY setting. Next, set your TV to the progressive scan mode. Refer to page 29 for instructions on changing the display setting. P.SCAN will appear on the display of the unit.
- If your TV is not compatible with progressive scanning, set PROGRESSIVE to OFF (refer to page 29). Make sure that P.SCAN on the display of the unit lights off.
- Use a commercially available adaptor if the video input jacks of your TV or monitor is the BNC type.

What is Progressive Scanning?

- Unlike conventional interlace scanning, the progressive scan system provides less flickering and images in higher resolution than that of traditional (525i/480i) television signals.

Manufactured under license from Dolby Laboratories. "Dolby" and the double-D symbol are trademarks of Dolby Laboratories.

Manufactured under license under U.S. Patent #: 5,451,942 & other U.S. and worldwide patents issued & pending. DTS and DTS Digital Out are registered trademarks and the DTS logos and Symbol are trademarks of DTS, Inc. © 1996-2007 DTS, Inc. All Rights Reserved.

CONNECTIONS

The following shows examples of connections commonly used to connect the DVD player to TV and other components.

If using this DVD player to play back a DVD in a Dolby Digital Multi channel surround or DTS surround format, the DVD player outputs a Dolby Digital or DTS data stream from its OPTICAL or COAXIAL DIGITAL OUT jacks.

By hooking up the player to a Dolby Digital or DTS decoder, you can enjoy more convincing, realistic ambience with powerful and high-quality surrounding sound of a professional standard which can be heard in movie theaters. Use a commercially available audio optical or coaxial digital cable for the audio connections.

NOTES:

- Be sure to turn off the power of all components in the system before connecting another component.
- Refer to the Instruction Manuals for your TV, stereo system and any other components to be connected to the DVD player.

Connection to an Audio System

Method 1

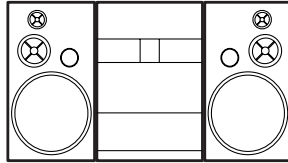

Stereo system

Method 2



AV amplifier with a built in decoder (AV control center),
Dolby Digital decoder,
DTS decoder,
MD deck or DAT deck

AUDIO

Audio Input Jacks

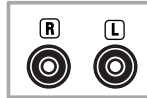

Audio cable
(supplied)

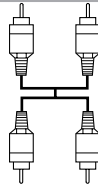

AUDIO OUT
(analog)



Digital Audio Input Jacks



Audio Coaxial
Digital cable
(commercially
available)

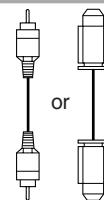

Optical cable
(commercially
available)

DIGITAL OUT

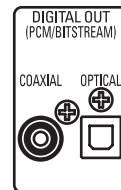

DVD

- **Method 1** DVD Player + Stereo system
- **Method 2** DVD Player + AV amplifier with a built in decoder (AV control center), Dolby Digital decoder, DTS decoder, MD deck or DAT deck

NOTES (for Method 2 only):

- When using an AV amplifier with a built in decoder (AV control center), Dolby Digital or DTS decoder as shown in the Method 2, set DOLBY DIGITAL or DTS to BITSTREAM accordingly for audio output in the setup mode (refer to page 30). Set it to PCM or OFF for the decoder that is not used currently. Playing back a DVD using incorrect settings may generate noise distortion, and may also damage the speakers.
- The audio source on a disc in a Dolby Digital Multi channel surround format cannot be recorded as digital sound by an MD deck or DAT deck.
- Set DOLBY DIGITAL to PCM and DTS to OFF for audio output in the setup mode for connecting to an MD deck or DAT deck (refer to page 30).
- Harsh noise that could harm your ears or the speakers is generated when a DVD recorded in DTS is played while using a decoder, etc., that is not DTS-compatible.
- When playing back a copyright-protected 96kHz PCM DVD, the digital sound will be down sampled at 48kHz, even if you set LPCM SELECT to OFF (refer to page 30).

Optical cable (commercially available)

- Optical cable (commercially available) may be damaged when bent at sharp angles. Ensure cables are coiled in loops with a diameter of 6 inches (15 cm) or more when storing them.
- Use a cable which is 9.8 feet (3m) or shorter.
- Insert cable plugs firmly into the connectors when making connections.
- If a plug has dust or is dirty, clean it with a soft cloth before inserting it into a connector.

Connection to a TV (for video)

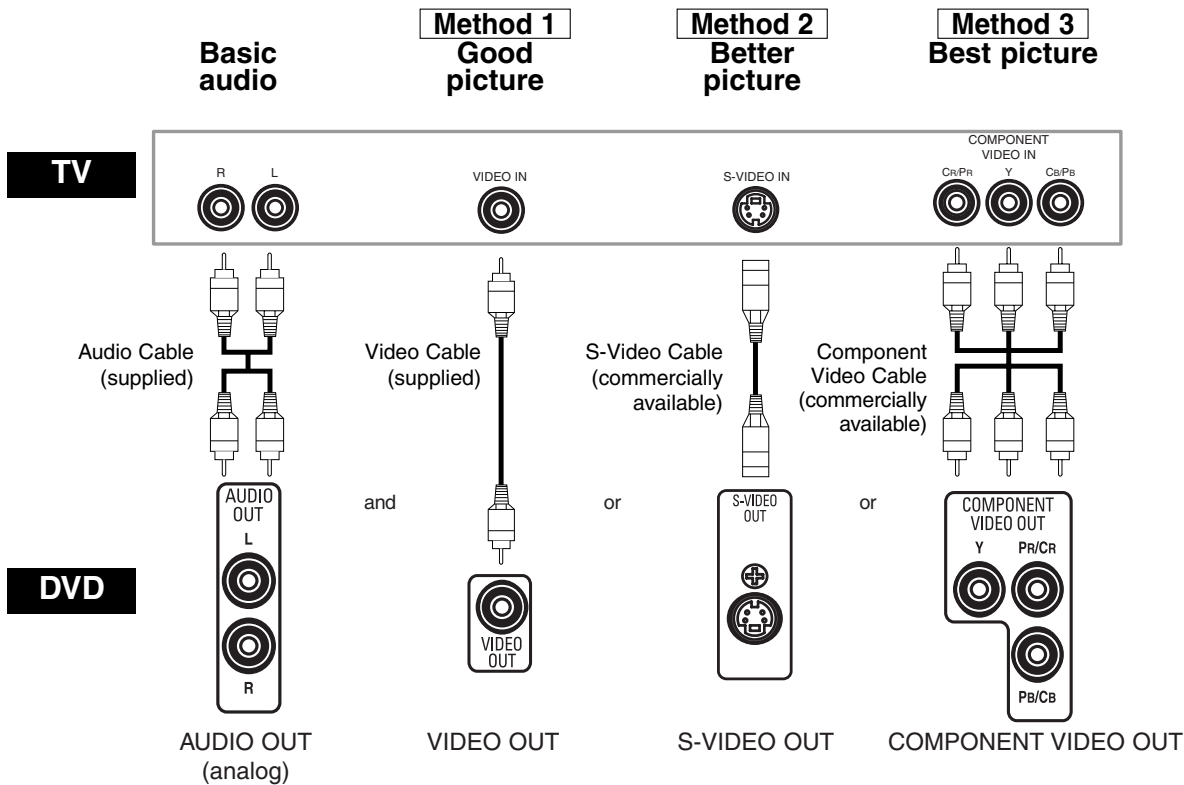

- **Method 1** DVD Player + TV with Video Input Jack
- **Method 2** DVD Player + TV with S-Video Input Jack
- **Method 3** DVD Player + TV with Component Video Input Jacks

NOTES:

- Connect the DVD player directly to a TV. If the Audio/Video cables are connected to a VCR, pictures may be distorted due to the copy protection system.
- S-Video output connector
The video signals are divided into color (C) and brightness (Y) signals, achieving a clearer picture.
If the TV is equipped with a S-Video input connector, we recommend connecting it to this unit's S-Video output connector using a commercially available S-Video connection cord.

HOW TO CONNECT TO A TV WITHOUT AUDIO/VIDEO INPUT JACKS

If your TV does not have RCA type audio and video input jacks it is still possible to connect this DVD player to your TV's 75-ohm coaxial antenna terminal using an optional Stereo Audio/Video RF Modulator, not included. Connect the audio and video outputs of the DVD player to the audio and video inputs on the RF Modulator, and then connect the coaxial output of the RF Modulator (usually marked "TO TV") to the 75 ohm coaxial antenna terminal on your TV. Follow the instruction supplied with the RF Modulator for more details.

If your TV's 75 ohm coaxial antenna terminal is already occupied by an antenna or cable box connection, remove that cable from your TV's antenna terminal and reconnect it to the coaxial antenna input terminal of the RF Modulator (usually marked "ANT IN"), then connect the RF modulator to your TV's antenna terminal as described above.

NOTE:

- The picture quality from DVD discs will not be as good if the DVD player is connected to the TV's antenna terminal through an RF Modulator.

CONNECTIONS

Connection to a TV with an HDMI Compatible Port

A simple 1-cable connection (using a commercially available cable) with a device having an HDMI (High-Definition Multimedia Interface) connector allows digital transfer of the digital images of DVD-Video and other sources.

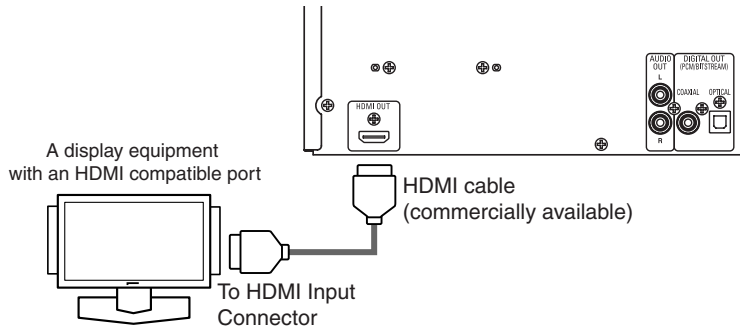

Actual output modes by media

	Audio Recording Format	DOLBY DIGITAL/DTS Setting	
		BITSTREAM ¹	PCM or OFF
DVD-Video	Dolby Digital	Dolby Digital	2 channel PCM
	DTS	DTS	—
	LPCM	2 channel PCM	2 channel PCM
DivX®	Dolby Digital	Dolby Digital	2 channel PCM
	MP3/MP2	2 channel PCM	2 channel PCM
Audio CD/Video CD		2 channel PCM	2 channel PCM
MP3/WMA		2 channel PCM	2 channel PCM

¹ If the connected equipment is not compatible with HDMI BITSTREAM, signals are output on PCM.

Copyright protection system

To play back the digital video images of a DVD via an HDMI connection, it is necessary that both the player and the display equipment (or an AV amplifier) support a copyright protection system called HDCP (High-bandwidth Digital Content Protection System). HDCP is copy protection technology that comprises data encryption and authentication of the connected AV equipment. This player supports HDCP. Please read the operating instructions of your display equipment (or AV amplifier) for more information.

*HDMI: High-Definition Multimedia Interface

NOTES:

- When using an HDMI-incompatible or HDCP-incompatible display equipment, the image will not be viewed properly.
- Among the devices that support HDMI, some devices can control other devices via the HDMI connector; however, this player cannot be controlled by another device via the HDMI connector.
- The audio signals from the HDMI connector (including the sampling frequency, the number of channels and bit length) may be limited by the equipment that is connected.
- Among the monitors that support HDMI, some do not support audio output (for example, projectors). In connections with equipment such as this, audio signals are not output from the HDMI output connector.
- When the set's HDMI connector is connected to a DVI-D compatible monitor (HDCP compatible) with an HDMI-DVI converter cable (commercially available), the signals are output in digital RGB.

"HDMI, the HDMI logo and High-Definition Multimedia Interface are trademarks or registered trademarks of HDMI Licensing LLC."

Basic Playback

DVD-V VCD CD MP3 JPEG
WMA DivX®

Getting started

- Turn on the power of the TV, amplifier and any other components which are connected to the DVD player.
- Make sure the TV and audio receiver (commercially available) are set to the correct channel.

- 1 Press the **POWER ON** button.
 - "P-ON" will appear briefly on the display panel.
- 2 Press the **OPEN/CLOSE** button to open disc loading tray.
- 3 Press the **DISC SKIP** button repeatedly or press the **DISC NUMBER** button.
 - The desired disc tray moves to the front position.
- 4 Place the disc in the tray, with the label facing up.
 - Repeat steps 3 and 4 to load more discs.

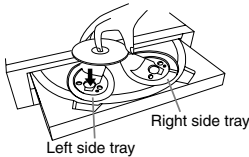

- 5 Press the **PLAY** button.
 - The tray will close automatically, and playback will start from the first chapter or track of the disc. If the playback does not start automatically, press the **PLAY** button.
 - If the disc has not been set on the left side tray, the DVD player will play the disc which is set on the right side tray.
 - When you want to select the other disc, press the **DISC SKIP** button repeatedly or the **DISC NUMBER** button for your desired disc.
 - When you playback the DVD with a title menu, it may appear on the screen. In this case, refer to "Title Menu".
- 6 Press the **STOP** button to stop playback.

NOTES:

- A "prohibited icon" may appear at the top-right on the TV screen during operation, warning that a prohibited operation has been encountered by the DVD player or the disc.
- With DVDs that use some titles for playback program signals, playback may start from the second title, or it may skip these titles.
- During the playback of two layered disc, pictures may stop for a moment. This happens when the 1st layer switches to the 2nd layer. This is not a malfunction.
- During the playback of a DVD-RW which has been recorded in the VR mode, the sound or picture may freeze momentarily depended on disc content.
- You can open the tray and change 2 discs during playback by pressing the **DISC EXCHANGE** button.
- Disc position will be displayed on the TV screen when you press **DISC NUMBER** or **DISC SKIP** button.



CANCELING AND CALLING BACK PBC FUNCTION

VCD

- 1 Insert a Video CD.
- 2 Press the **STOP** button.
- 3 Press the **Numeric** buttons to enter the desired Track number.
 - PBC function is now canceled and the playback of the Video CD will start.
- 4 To call back PBC function, press the **STOP** button twice, and then press the **PLAY** button.
 - The title menu will appear on the TV screen.

HDMI Setup

- 1 Press the **HDMI** button on the front panel to select the HDMI output mode. The output mode changes as follows every time the **HDMI** button is pressed.
 - The HDMI indicator on the front panel lights up when HDMI output mode is on.

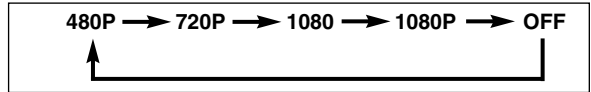

480P (Default): Video output from the HDMI OUT jack at 480p.
 720P: Video output from the HDMI OUT jack at 720p.
 1080: Video output from the HDMI OUT jack at 1080i.
 1080P: Video output from the HDMI OUT jack at 1080p.
 OFF: No video output from the HDMI OUT connector.

NOTES:

- Video and audio signals may distorted temporarily when switching to/from the HDMI output mode.
- Use a display equipment with an HDMI-compatible port.
- The HDMI indicator on the front panel flashes when you select the HDMI output mode but there is no HDMI cable.
- You can check the HDMI connection status by pressing the **DISPLAY** button during playback with the HDMI output mode (refer to page 26).
- If the TV is not compatible with newly selected HDMI output mode, the actual output mode will be kept the one before changing the selection. When this occurs, the newly selected mode will appear on the front panel display (see page 11) while the actual output resolution will be indicated by performing the on-screen display as described on page 26.

General Features

DVD-V

DVD may contain menus to navigate the disc and access special features. Press the appropriate **Numeric** buttons or use the **Cursor** buttons (▲ / ▼ / ◀ / ▶) to highlight your selection in the DVD main menu and press the **ENTER** button to confirm.

NOTE:

- Unless otherwise stated, all operations described in this manual are based on remote control use. Some operations can be carried out using the menu bar on the TV screen.

Disc Menus

DVD-V

- 1 Press the **MENU** button.
 - The DVD main menu will appear.
- 2 If the feature is not available, symbol may appear on the TV screen.
- 3 If disc menu is available on the disc, audio language, subtitle options, chapters for the title and other options will appear for selection.
- 4 Press the **Cursor** buttons (▲ / ▼ / ◀ / ▶) to select an item, and the **ENTER** button to confirm the selection.

DISC PLAYBACK

Title Menu

DVD-V

- 1 Press the **TOP MENU** button.
 - The title menu will appear.
- 2 If the feature is not available,  symbol may appear on the TV screen.
- 3 Press the **Cursor** buttons (**▲** / **▼** / **◀** / **▶**) to select an item, and the **ENTER** button to confirm the selection.
 - Playback will begin at the selected title.

VCD

- 1 When playing back a Video CD with PBC function, the title menu will appear automatically.
- 2 Press the **Numeric** buttons to select the desired title.
 - Playback will begin at the selected title.
- 3 Press the **RETURN** button to go back to the title menu.

CALLING UP A MENU SCREEN DURING PLAYBACK

DVD-V

- Press the **MENU** button to call up the DVD main menu.
- Press the **TOP MENU** button to call up the title menu.

NOTE:

- Contents of menus and corresponding menu operations may vary among discs. Refer to the manual accompanying the disc for details.

Still / Pause

DVD-V VCD CD MP3 JPEG
WMA DivX®

- 1 During playback, press the **STILL/PAUSE** button.
 - Playback will pause and sound will be muted.
- 2 To continue playback, press the **PLAY** button.



NOTE:

- On DVDs set STILL MODE to FIELD on the display menu if pictures in the pause mode are blurred (refer to page 29).

Resume

DVD-V VCD CD MP3 JPEG
WMA DivX®

- 1 During playback, press the **STOP** button.
 - Resume message will appear on the TV screen.
- 2 Press the **PLAY** button, playback will resume from the point at which playback was stopped.
 - To cancel resume, press the **STOP** button twice.

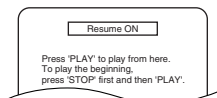

<Example: DVD>

NOTES:

- Some Video CDs with PBC function resume playback from the beginning of the track.
- The resume information will be saved even when the power is turned off.
- For MP3, JPEG or WMA, playback will resume from the beginning of the current track.

Fast Forward / Reverse Search

DVD-V VCD CD MP3 WMA
DivX®

- 1 During playback, press the **◀◀** or **▶▶** button repeatedly to select a desired forward or reverse speed.

◀◀ Button

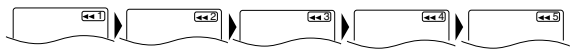

▶▶ Button

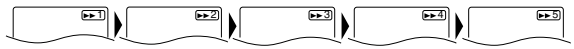

- For DVDs, fast forward or reverse search speed is different depending on the disc. The approximate speed is 1 (x2), 2 (x8), 3 (x20), 4 (x50), and 5 (x100).
 - For Video CDs, Audio CDs, MP3, WMA and DivX®, the approximate speed is 1 (x2), 2 (x8), and 3 (x16).
 - For Video CDs, Audio CDs, MP3, WMA and DivX® sound will be output at any speed of fast forward and reverse search.
- 2 To return to normal playback, press the **PLAY** button.

NOTE:

- For some DivX® files, Fast Forward/Reverse Search may not function.

Slow Forward / Slow Reverse

DVD-V VCD DivX®

- 1 During playback, press the **STILL/PAUSE** button.
- 2 Press the **◀◀** or **▶▶** button.
 - Slow motion playback will begin and sound will be muted.
- 3 Press the **◀◀** or **▶▶** button repeatedly to select a desired speed.
 - Slow forward or reverse speed is different depending on the disc. Approximate speed is 1 (1/16), 2 (1/8), and 3 (1/2).
- 4 To return to normal playback, press the **PLAY** button.

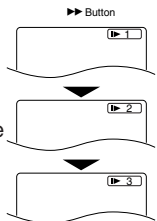

NOTES:

- On DVDs, set STILL MODE to FIELD on the display menu if pictures in the slow playback mode are blurred (refer to page 29).
- Only Slow Forward is available when playing back Video CD and discs with DivX® files.

Step by Step Playback

DVD-V VCD DivX®

- 1 During playback, press the **STILL/PAUSE** button.
 - Playback will pause and sound will be muted.
- 2 The disc advances frame by frame each time the **STILL/PAUSE** button is pressed.
- 3 To exit step by step playback, press the **PLAY** button.



NOTE:

- On DVDs, set STILL MODE to FIELD on the display menu if pictures in the pause mode are blurred (refer to page 29).

DISC PLAYBACK

Zoom

DVD-V VCD JPEG DivX®

This function allows you to enlarge the video image and to pan through the zoomed image.

- 1 Press the **ZOOM** button during playback.
 - Playback will continue.
- 2 Press the **ZOOM** button repeatedly to select a desired zoom factor: x2, x4 or off.
 - Only x2 zoom is available on Video CDs, JPEG and DivX®.



- 3 Use the **Cursor** buttons (▲/▼/◀/▶) to move the zoomed picture across the screen.

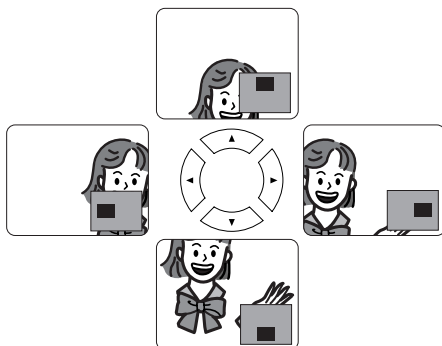

- 4 To exit zoom mode, press the **ZOOM** button.

NOTES:

- Zoom function does not work while disc menu is shown.
- x4 zoom is not available on some discs.
- Navigation screen is not available on JPEG.
- You cannot pan through the zoomed picture on some JPEG files.

Title / Chapter Search

DVD-V

By using the SEARCH MODE button

- 1 Press the **SEARCH MODE** button repeatedly until the chapter search or the title search display appears during playback.
- 2 Enter the desired chapter/title number with the **Numeric** buttons.



By using the SKIP buttons ◀◀▶▶

During playback, press the **SKIP ▶▶** button to move to the next chapter. Press it repeatedly to skip to subsequent chapters. Press the **SKIP ◀◀** button to go back to the beginning of the current chapter. Press it repeatedly to go to the previous chapters.

- Chapter number will appear briefly on the front display panel.
- If the **SKIP ◀◀** or **▶▶** button is pressed while the playback is paused, the playback after skipping to the next chapter will be also paused.

NOTES:

- Depending on the disc being played, the **Numeric** buttons can be used to search for a desired chapter by entering the chapter number directly. Refer to the manual accompanying the disc.
- The **SKIP ◀◀** and **▶▶** buttons are not available when playback is stopped.
- A disc that does not contain chapters within titles, the **SKIP ◀◀** and **▶▶** buttons change the titles.

Track Search

VCD CD MP3 JPEG WMA
PBC OFF DivX®

There are two ways to begin playback a disc at a specific track.

By using the SEARCH MODE button

- 1 Press the **SEARCH MODE** button.
 - The track search display appears.
- 2 Within 30 seconds, select a desired track number using the **Numeric** buttons.
 - For the disc with less than 10 tracks, press the track number directly.
 - For discs with 10 or more but less than 100 tracks, to play back a single-digit track, press **0** first, then the track number (e.g. for track 3, press **0, 3**). To play back a double-digit track, press the track number.
 - For discs with 100 or more tracks, to play back a single- or a double-digit track, press **0** first, then the track number (e.g. for track 3, press **0, 0, 3**, and for track 26, press **0, 2, 6**). To play back a triple-digit track, press the track number.
 - Press the **CLEAR** button to erase the incorrect input.

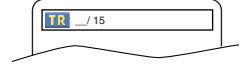

NOTE:

- The **+10** button can also bring up the track search display except for the disc with less than 10 tracks. For such a disc, track search can be done by just pressing the track number.

By using the SKIP buttons ◀◀▶▶

During playback, press the **SKIP ▶▶** button to move to the next track. Press it repeatedly to skip to subsequent tracks. Press the **SKIP ◀◀** button to go back to the beginning of the current track. Press it repeatedly to go to the previous tracks.

- Track number will appear briefly on the front panel display.
- If the **SKIP ◀◀** or **▶▶** button is pressed while the playback is paused, the playback will be paused again after skipping to the next track.

NOTE:

- The **SKIP ◀◀** and **▶▶** buttons are not available when playback is stopped.

Time Search

DVD-V VCD CD DivX®
PBC OFF

- 1 Press the **SEARCH MODE** button until the time search screen appears on the TV screen.



- 2 Within 30 seconds, enter a desired disc time point on the disc with the **Numeric** buttons.
 - Playback will start at the specified time.
 - For Time Search, "0" appears automatically when there is no need to enter a number. For example, "0:0:_" appears in the time search screen if the total time of the disc is less than 10 minutes.
- 3 Press the **CLEAR** button to erase an incorrect input.

NOTE:

- For some DivX® files, Time Search may not function.

DISC PLAYBACK

Marker Setup Screen



You can use markers to memorize your favorite places on a disc.

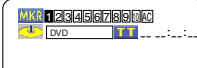

- Press the **SEARCH MODE** button repeatedly until the display screen and Markers appear during playback.
- Press the **Cursor** buttons (◀ or ▶) to select 1, 2, 3, 4, 5, 6, 7, 8, 9, or 10 and ensure that “ _ : _ : _ ” appears in the display.
- When the disc reaches the point you want to remember, press the **ENTER** button.
 - The title or track and elapsed playback time will appear in the TV screen.
- To return to the Marker later, press the **SEARCH MODE** button repeatedly during playback and the **Cursor** buttons (◀ or ▶) to choose a desired marker, then press the **ENTER** button.
- Press the **SEARCH MODE** or **RETURN** button to exit.

NOTES:

- Opening the disc tray, turning off the power or selecting AC at step 2 and pressing the **ENTER** button will erase all Markers.
- To clear a marker, using the **Cursor** buttons (◀ or ▶), position the cursor on to the marker number to be cleared and press the **CLEAR** button.
- You can mark up to 10 points.

Repeat

- The **REPEAT** button is available only during playback.

REPEAT TITLE / CHAPTER

DVD-V

To activate Repeat function, press the **REPEAT** button during playback.

- The repeat mode changes as described below every time you press the button.

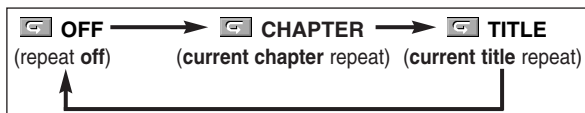

NOTES:

- The Repeat Title/Chapter setting will be cleared when moving to other title or chapter.
- Repeat playback does not function during A-B repeat playback.
- Repeat Title/Chapter is not available with some scenes.

REPEAT TRACK / GROUP / DISC

VCD CD
PBC OFF

To activate Repeat function, press the **REPEAT** button during playback.

- The repeat mode changes as described below every time you press the button.

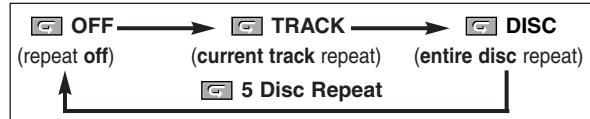

NOTES:

- In the track repeat, the repeat setting will be cleared when moving to other track.
- Repeat playback does not function during A-B repeat playback.
- You cannot set up to the 5 Disc Repeat in Video CD.

MP3 JPEG WMA DivX®

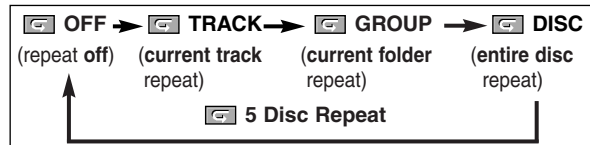

NOTES:

- In the track or group repeat, the repeat setting will be cleared when moving to other track or group.
- You cannot set up to the 5 Disc Repeat in DivX®.

A-B REPEAT

DVD-V VCD CD DivX®

- Press the **A-B REPEAT** button at your chosen starting point.

- A-** appears briefly on the TV screen.

- Press the **A-B REPEAT** button again at your chosen end point.

- A-B** appears briefly on the TV screen, and the repeat sequence begins.

- To exit the sequence, press the **A-B REPEAT** button.

NOTES:

- The A-B Repeat section can only be set within the current title (for DVD-Video), or current track (for Audio CD, Video CD and with DivX® files).
- A-B Repeat is not available with some scenes on DVD.
- To cancel the A point which was set, press the **CLEAR** button.
- A-B Repeat playback does not function during title, chapter, track, group, disc or 5 disc repeat playback.
- For some DivX® files, A-B Repeat playback may not function.

Program Playback

This function allows you to program a playback order of Audio CD, MP3, JPEG, or WMA in a desired sequence.

CD

You may determine the order in which tracks will play.

1 In stop mode press the **MODE** button.

- The PROGRAM screen will appear.

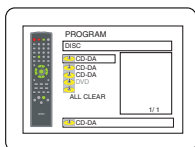

2 Press the **Cursor** buttons (▲ or ▼) to select a disc, then press the **ENTER** button.

- Press the **CLEAR** button to erase the most recently entered program.

3 Press the **Cursor** buttons (▲ or ▼) to select a track, then press the **ENTER** button.

- Press the **CLEAR** button to erase the most recently entered program.

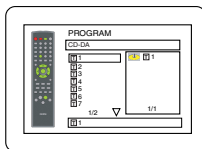

4 Press the **PLAY** button to start programmed playback.

NOTE:

- DVD-Video, MP3, JPEG and WMA discs will display in gray when "PROGRAM [5DISC]" screen appears.

MP3

JPEG

WMA

1 In stop mode, press the **MODE** button.

- The PROGRAM screen will appear.

2 Press the **Cursor** buttons (▲ or ▼) to select a group, then press the **ENTER** button.

- A track selection screen appears.

3 Press the **Cursor** buttons (▲ or ▼) to select a track, then press the **ENTER** button to save it in a program.

- Press the **CLEAR** button to erase the most recently entered track.

- The programmed track is displayed in the right-hand screen.

- If the entire program cannot be displayed on the screen, "▼" appears.

- Pressing the **Cursor** button (◀) will show a list of folders that belong to the hierarchy which is one-level higher than the currently selected folder.

4 Press the **PLAY** button to start programmed playback.

- Press the **RETURN** button, and the stop screen will show up with the program contents in memory.

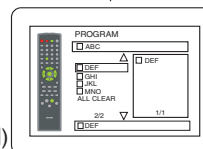
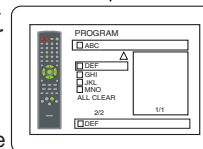
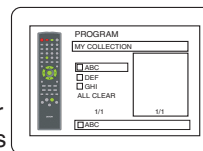

NOTES:

- Press the **STOP** button once and then the **PLAY** button again, playback will restart from the point where the **STOP** button was pressed. (Program continued.)
- Press the **STOP** button twice and then the **PLAY** button again, playback will restart from the first track in the usual way. Your program is still stored until either the disc tray is open or power is turned off.
- Up to 99 tracks can be entered.
- To erase tracks in the program all together, select **ALL CLEAR** at the bottom of the list at step **2**. And, "A-CLEAR" is displayed on the front panel display at that time.
- To repeat the current track in the program, press the **REPEAT** button repeatedly until TRACK appears during playback. To repeat the entire program press the **REPEAT** button repeatedly until DISC or 5DISC appears during playback.
- If eight or more tracks were set in a program, use the **SKIP** or button to see all the tracks.
- When selecting the folder:
 - Press the **Cursor** button (▶) when you want to go to the next hierarchy.
 - Press the **Cursor** button (◀) when you want to go back to the previous hierarchy (except for the top hierarchy).
- Even if an inserted disc contains mixed MP3, JPEG and WMA files, Program function allows 99 tracks in combination of MP3, JPEG and WMA files.
- The front panel display has blinked while setting the program playback.
- "F-***" is displayed on the front panel display while selecting the group (folder). (*** is group (folder) number.)
- MP3, JPEG and WMA discs will display in gray and you cannot select them when "CD" screen appears.

Random Playback

This function shuffles the playback order of tracks instead of playback in the original sequence.



When playing back tracks in a single disc randomly.

- 1 In stop mode, press the **RANDOM** button once or press the **MODE** button twice.
 - The RANDOM screen is displayed.
- 2 Press the **PLAY** button to start random playback.

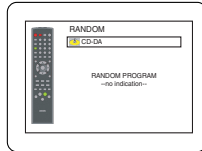

<Example: CD>

When playing back tracks in more than one discs randomly.(only CD-DA)

- 1 In stop mode, press the **RANDOM** button twice or press the **MODE** button three times.
 - The RANDOM [5DISC] screen is displayed.
- 2 Press the **PLAY** button to start random playback.

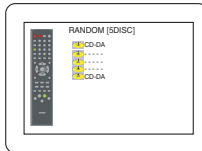

NOTES:

- MP3, JPEG and WMA discs will display in gray when “RANDOM [5DISC]” screen appears. Unknown disc will displays as “- - - -”, or blank if there is no disc in the tray.
- If you wish to repeat the current track in the random selection, press the **REPEAT** button repeatedly until TRACK appears during playback. If you wish to repeat the entire random selection, press the **REPEAT** button repeatedly until DISC or 5DISC appears during playback.
- You cannot go back to the previous track during random playback.
- “SHUFFLE” or “5-SHUFF” is displayed on the front panel display at Step 1.

MP3 / JPEG / WMA Playback



When a CD-R or CD-RW disc with MP3, JPEG or WMA files is inserted in the DVD player, the file list will appear automatically on the TV screen. The number of tracks is also displayed on the front panel.

- 1 Press the **Cursor** buttons (▲ or ▼) to select the desired group (folder) or track.
 - To return to the previous screen, press the **Cursor** button (◀).
 - If a group (folder) is selected, press the **Cursor** button (▶) or **ENTER** button to go on to the track selection screen. Press the **Cursor** buttons (▲ or ▼) to choose a track, then press the **PLAY** or **ENTER** button.
 - If a track is selected, press the **PLAY** or **ENTER** button to start playing back tracks. The selected track and the subsequent tracks will be played back.
 - When selecting the folders
 - Press the **Cursor** button (▶) when you want to go to the next hierarchy.
 - Press the **Cursor** button (◀) when you want to go back to the previous hierarchy (except for the top hierarchy).
 - Press the **TOP MENU** button to return to the first item.
- 2 Press the **STOP** button to stop playback.

NOTES:

- Folders are known as Groups; files are known as Tracks.
- A symbol of is shown on the top of the group name.
- A symbol of is shown on the top of MP3 files.
- A symbol of is shown on the top of JPEG files.
- A symbol of is shown on the top of WMA files.
- Maximum of 255 folders can be recognized.
- Maximum of 999 files can be recognized.
- Up to 8 hierarchies can be recognized.
- If the track extends beyond the scope of screen, a down arrow “▼” appears, indicating that the user can view another part on the previous page. The current page number and the number of total pages are shown on the left of the down arrow “▼”.
- If no MP3, JPEG or WMA files are found in the group, the group is not displayed.
- The DVD player can reproduce data recorded as per ISO 9660 Level 1, Level 2 or Joliet on the disc.
- It can also run a disc on which data is recorded in a multi-session.
- For more details of recording systems, refer to the instruction manual for the CD-R/RW drive or the writing software.
- For MP3 and WMA files recorded in Variable Bit Rate (VBR), the unit may not display the actual elapsed time.
- In stop mode, press the **MENU** button. File list appears.

DISC PLAYBACK

This player recommends the use of files recorded at the following specifications:

Applicable MP3 file		Remarks
Sampling frequency	44.1kHz 48kHz	• It is prohibited to record MP3 sound on a digital device when the connection is made digitally.
Type	MPEG1 audio layer 3	• MP3 files recorded at fixed bit rate of 32 kbps or higher are recommended.

Applicable JPEG file		Remarks
Size of image	Upper limit: 6300x5100 dots Lower limit: 32x32 dots	• A JPEG image that extends beyond the screen is reduced so that it will be displayed within the screen.

Applicable WMA file		Remarks
Sampling frequency	44.1kHz 48kHz	• Those frequencies are applicable to WMA version 9.
Bit rate	48–192kbps	• Ensure that the copyright function is set to off when preparing a WMA disc.
Type	WMA version 9	• A prohibition “disable” symbol will appear if the user attempts to run a non-reproducible file such as copyright-protected. • Recorded in 5.1 channel format cannot be played back.

Information on MP3, JPEG and WMA discs

- This DVD player can play back images and sounds from data recorded in MP3 and JPEG formats on CD-R/RW discs.
- A file with an extension of “.mp3 (MP3)” is called an MP3 file.
- A file with an extension of “.jpg (JPG)” or “.jpeg (JPEG)” is called a JPEG file.
The DVD player can run an image file conforming to the Exif specification. Exif is a file format, Exchangeable Image File format established by Japanese Electronic Industry Development Association (JEIDA).
- A file with an extension of “.wma (WMA)” is called a WMA file.
- Files whose extension is other than “.mp3 (MP3)”, “.jpg (JPG)” and “.jpeg (JPEG)” or “.wma (WMA)” will not be listed on the MP3, JPEG or WMA menu.
- If the file is not recorded in MP3, JPEG or WMA format, noise may be produced even if the file extension is either “.mp3 (MP3)”, “.jpg (JPG)”, “.jpeg (JPEG)” or “.wma (WMA)”.
- The name of group and track can be displayed up to 25 characters. Unrecognizable characters will be replaced with asterisks. The ninth and deeper hierarchies cannot be displayed.
- Unplayable groups or tracks may be displayed depending on the recording conditions.
- If the **TOP MENU** button is pressed when a file list is displayed, the first item will be highlighted.

Kodak Picture CD

The DVD player can also run JPEG files stored on Kodak Picture CDs. You can enjoy picture images on the television set by playing back the Picture CDs.

This unit conform to ver.7.0 of Kodak Picture CD.

For details of Kodak Picture CD, contact a shop that provide developing service of Kodak Inc.

- When Kodak Picture CD is inserted in the DVD player, Kodak Picture CD menu appear automatically on the TV screen.

- If all menu items cannot be displayed on the screen scope, “▶▶” appears at the right bottom of the screen, indicating that the user can view remaining items on the next page. “◀◀” appears, it indicates that the user can view other items on the previous page. The track number of the currently highlighted item and the total tracks are shown at the center bottom of the screen.

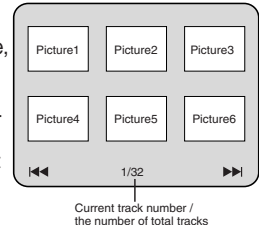

- If “▶▶” is shown at the right bottom, use the **SKIP ▶▶** button to view the next page. If “◀◀” is shown at the left bottom, use the **SKIP ◀◀** button to view the previous page.
- It may take some time until all menu items are displayed on the menu screen.

- Press the **Cursor** buttons (▲ / ▼ / ◀ / ▶), select a desired track to be played back, then press the **PLAY** or **ENTER** button.

- If a Kodak Picture CD file is selected, an image will be played back from the selected track and go to the next one in turn.

- Press the **STOP** button, to stop playback.

NOTES on JPEG and Kodak Picture CD:

- A track is displayed for 5 or 10 seconds and then the next track is displayed.
- Every press on the **ANGLE** button will turn the image clockwise by 90 degrees when an image is displayed.
- To change the size of the playback image, press the **MODE** button twice. The size change mode appears on top of the TV screen during playback. Then press the **Cursor** buttons (◀ or ▶) or **ENTER** button to switch between **NORMAL** (100%) and **SMALL** (95%).
- Progressive JPEGs (JPEG files saved in the progressive format) will not be played back on this DVD player.
- High resolution JPEG files take longer to be displayed.
- The size change mode may have no effect on some files (e.g. files with a small picture size).
- In stop mode, press the **MENU** button. Kodak Picture CD menu appears.

NOTES on WMA:

- The DVD player can reproduce data recorded as ISO 9660 level 2 with 31 characters file name included punctuation marks. The name of file can be displayed up to 25 characters.
- Maximum of 8 subfolders can be recognized.
- It can also be displayed tag information of WMA at least 64 characters.
- A file with an extension of Joliet as Unicode format in up to 64 characters can be recognized.
- This unit cannot play back copyright protected WMA files.

DivX® Playback



This DVD player can play back DVD-R/RW and CD-R/RW discs recorded in DivX® format. When a DVD-R/RW or CD-R/RW with DivX® files is inserted in the DVD player, the file list will appear automatically on the TV screen. The number of tracks will be also displayed on the front panel.

- 1 Press the **Cursor** buttons (▲ or ▼) to select the desired group (folder) or track.
 - To return to the previous screen, press the **Cursor** button (◀).
 - If a group (folder) is selected, press the **Cursor** button (▶) or **ENTER** button to go on to the track selection screen. Press the **Cursor** buttons (▲ or ▼) to choose a track, then press the **PLAY** or **ENTER** button.
 - If a track is selected, press the **PLAY** or **ENTER** button to start playing back tracks. The selected track and the subsequent tracks will be played back.
 - When selecting the folders:
 - Press the **Cursor** button (▶) when you want to go to the next hierarchy.
 - Press the **Cursor** button (◀) when you want to go back to the previous hierarchy (except for the top hierarchy).
 - Press the **TOP MENU** button to return to the first item.

2 Press the **STOP** button to stop playback.

NOTES:

- DivX® is a codec (compression/decompression) that can compress images to a very small amount of data. The software can compress video data from almost any sources to the size that can be sent on the Internet without compromising visual quality of the images.
- A file with an extension of “.avi” or “.divx” is called an DivX® file. All files with the “.avi” extension are recognized as MPEG 4.
- Files with extension other than “.avi” and “.divx” will not be listed on the DivX® menu. However, unplayable groups or tracks may be displayed, depending on the recording conditions.
- Even if the file has an extension of either “.avi” or “.divx”, this player cannot play it back if it is recorded in the format other than DivX®.
- Folders are known as Groups; files are known as tracks.
- A symbol of is shown on the top of DivX® file.
- Maximum of 255 folders can be recognized.
- Maximum of 999 files can be recognized.
- If the track extends beyond the scope of screen, a down arrow “▼” appears, indicating that the user can view another part on the previous page. The current page number and the number of total pages are shown on the left of the down arrow “▼”.
- The name of group and track can be displayed up to 25 characters. Unrecognizable characters will be replaced with asterisks. The ninth and deeper hierarchies cannot be displayed.
- You can play back the disc recorded in multi-session.
- Playback will be paused if the file list is displayed during the playback.
- It may take a while for audio and images to be output after you inserted a disc and pressed the **PLAY** button.
- When playing back the files recorded in high bit rates, the images can be interrupted on some occasions.
- Although DivX® logo has been obtained for this player, it may not be able to play back some data, depending on the disc characteristics, bit rates, or audio format settings, etc.
- Use the software recognized by DivX®, Inc. when you make DivX® files.

- When using tools or utilities to make up DivX® files, read their instruction manual beforehand.
- A DivX® file whose file size exceeds 2GB cannot be played back.
- If a large-sized DivX® file is selected, it may take a while to start the playback (over 20 seconds sometimes).
- Constant bitrate of image between 500 kbps and 4,000 kbps is recommended if you make DivX® files on a CD-R/RW.
- If DivX® files written on CD discs cannot be played back, rewrite them on a DVD disc and try to play back.
- For more information for DivX®, please visit: <http://www.divx.com>
- If you insert a CD-R/RW with DivX® files that are mixed with MP3, JPEG, or WMA files, the Playback Media Selection screen will be displayed. Please select Video and proceed to Step 1.



- Press the **TOP MENU** button to call up the Playback Media Selection screen in stop mode.
- If you select Audio & Pictures, instead of Video on the Playback Media Selection screen, the DVD player can play back MP3/JPEG/WMA files. Refer to page 22 for details.

This player recommends the use of files recorded at the following specifications:

Applicable DivX® file	Remarks
Playable Codec of AVI files	Plays all versions of DivX® video (including DivX® 6) with standard playback of DivX® media files. • They are recognized as MPEG 4.
Maximum size of image	720 x 480 @30fps 720 x 576 @25fps
Sampling frequency of audio	8kHz - 48kHz • It is prohibited to record MP3 sound on a digital device when the connection is made digitally.
Audio type	MPEG1 audio layer 3 (MP3) MPEG1 audio layer 2 Dolby Digital • MP3 files recorded at fixed bit rate of 32kbps or higher are recommended.

DivX® Subtitle



The subtitle created by the user can be displayed during DivX® playback.

- 1 After select the DivX® file, the SUBTITLE LIST will appear except when the “DivX SUBTITLE” setting is “OFF”. Refer to “Language Setting” on page 29.

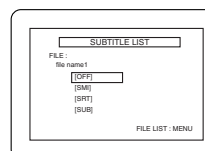

2 Press the **Cursor** buttons (▲ or ▼) to select the desired extension you want to display, then press the **ENTER** button. DivX® with the subtitle starts playback. The subtitle cannot be displayed when the setting is “OFF”.

- If there is more than one extension, the extension selection appears in the SUBTITLE LIST.

NOTES:

- DivX® subtitle can only be displayed according to the same name with an extension of the DivX® file name.
- Files whose extension is other than “.SMI”, “.smi”, “.SRT”, “.srt”, “.SUB” and “.sub” will not be listed in the SUBTITLE LIST.
- This unit cannot be recognized if the DivX® file and its subtitle file are not in the one folder.
- The subtitle may not be displayed if the file size is too large.
- To change the subtitle, refer to “Subtitle Language” on page 27 if multiple subtitles are available.
- The subtitle cannot display if the on-screen information is displayed.
- If “DivX SUBTITLE” is set to “OFF” in LANGUAGE menu, the SUBTITLE LIST will not be displayed even if you select a DivX® file with created subtitle.
- Unrecognizable characters will be replaced with asterisks.

Changing the On-Screen Display

You can check information about the current disc by pressing the **DISPLAY** button on the remote control.

DVD-V

1 Press the **DISPLAY** button once during playback to show current disc number.

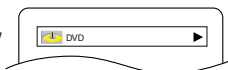

2 Press the **DISPLAY** button during playback.

- Current chapter number/total chapters, elapsed time and remaining time of the current chapter, and current playback status will be displayed.

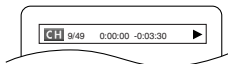

3 Press the **DISPLAY** button again.

- Current title number/total titles, elapsed time and remaining time of the current title, and current playback status will be displayed.



4 Press the **DISPLAY** button again.

- The bit rate (the amount of video data currently being read) and current playback status will be displayed.
- Current repeat setting appears on the right side of the display bar only when the repeat setting is active. (◀ C: Chapter repeat/ ▶ T: Title repeat/A ◀ B: A-B repeat)
- If you are playing back a two-layered disc, the layer number will also be displayed. (L0: Layer 0 is being played back. L1: Layer 1 is being played back.)

5 Press the **DISPLAY** button again.

- Current HDMI status will be displayed during the HDMI output mode.

6 Press the **DISPLAY** button again to exit.

VCD **CD**

1 Press the **DISPLAY** button once during playback to show current disc number.

2 Press the **DISPLAY** button during playback.

- Current track number/total tracks, elapsed time and remaining time of the current track, and current playback status will be displayed.
- Current repeat setting appears on the right side of the display bar only when the Repeat setting is active. (◀ T: Track repeat/ ▶ D: 1 Disc repeat/ ▶ 5: 5 Disc repeat/A ◀ B: A-B repeat)

3 Press the **DISPLAY** button again.

- Current track number/total tracks, elapsed time and remaining time of the entire disc, and current playback status will be displayed.
- Current repeat setting appears on the right side of the display bar only when the Repeat setting is active.
- On Audio CDs, when you are playing back a disc in program or random mode, PROGRAM (or RANDOM) will be displayed.

4 Press the **DISPLAY** button again.

- During program or random playback, each playback status will be displayed when you press the **DISPLAY** button. Then press the **DISPLAY** button again.
- Current HDMI status will be displayed during the HDMI output mode.

5 Press the **DISPLAY** button again to exit.

MP3 **JPEG** **DivX®**

1 Press the **DISPLAY** button once during playback to show current disc number.

2 Press the **DISPLAY** button during playback.

- Current file name will be displayed.

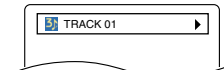

<Example: MP3>

3 Press the **DISPLAY** button again.

- For MP3, current track number/total tracks, elapsed time of the current track, and current playback status will be displayed.
- For JPEG, current track number/total track will be displayed.
- For discs with DivX® files, current track number/total tracks, elapsed time and remaining time of the current track, and current playback status will be displayed.
- Current repeat setting appears only when the Repeat setting is active. (◀ T: Track repeat/ ▶ G: Group (Folder) repeat/ ▶ D: 1 Disc repeat/ ▶ 5: 5 Disc repeat (except for DivX®) /A ◀ B: A-B repeat (DivX® only)) Δ .
- When you are playing back a disc with MP3 or JPEG files in program or random mode, PROGRAM (or RANDOM) will be displayed.

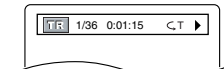



4 Press the **DISPLAY** button again.

- During program or random playback, each playback status will be displayed when you press the **DISPLAY** button. Then press the **DISPLAY** button again.
- Current HDMI status will be displayed during the HDMI output mode.

5 Press the **DISPLAY** button again to exit.

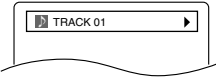
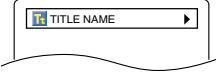
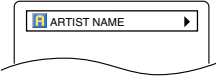
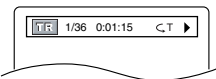
WMA

- 1** Press the **DISPLAY** button once during playback to show current disc number. 
- 2** Press the **DISPLAY** button during playback.
 - Current file name will be displayed. 
- 3** Press the **DISPLAY** button again.
 - Title name based on tag information of currently played-back file will be displayed. 
- 4** Press the **DISPLAY** button again.
 - Artist name based on tag information of currently played-back file will be displayed. 
- 5** Press the **DISPLAY** button again.
 - Current track number/total tracks and elapsed time will be displayed.
 - Current repeat setting appears only when the Repeat setting is active. (◁ T: Track repeat/ ◁ D: 1 Disc repeat/ ◁ 5: 5 Disc repeat/ ◁ G: Group (folder) repeat).
 - When you are playing back a disc in program or random mode,  PROGRAM (or RANDOM) will be displayed.
- 6** Press the **DISPLAY** button again.
 - During program or random playback, each playback status will be displayed when you press the **DISPLAY** button. Then press the **DISPLAY** button again.
 - Current HDMI status will be displayed during the HDMI output mode.
- 7** Press the **DISPLAY** button again to exit.

NOTE:

- If the file does not contain tag information, NOT AVAILABLE will be displayed.

NOTE FOR HDMI DISPLAY:

- The displayed HDMI status are as follows:
 1. Information for image output/Resolution of image
 2. Sound output format
 3. Maximum number of audio channels that can be accepted by the connected equipment



Slide Show Mode

JPEG

You can switch to the slide show mode during playback.

- 1** Press the **MODE** button during playback.
 - The slide show mode screen will appear.
 - You cannot change to the slide show mode in stop mode or from the file list screen or the Picture CD menu screen.
- 2** Press the **ENTER** button.
 - The slide show mode will change.
 - CUT IN/OUT: The entire image appears in one time.
 - FADE IN/OUT: The image appears and disappears gradually.
- 3** Press the **MODE** button to exit.

Dialog Speed

DVD-V

Available only on discs recorded in the Dolby Digital format, Dialog Speed plays back in slightly faster or slower speed while keeping the sound quality as in the normal playback.

- 1** During playback, press the **MODE** button repeatedly until the Dialog Speed setting appears. 
 - OFF appears on the TV screen.
- 2** Press the **ENTER** button or the **Cursor** buttons (◀ or ▶) to switch among ♪♪ (x1.3), ♪ (x0.8) and OFF.
 - ♪: Plays back approximately at 0.8 times of normal playback.
 - ♪♪: Plays back approximately at 1.3 times of normal playback.
- 3** To return to normal playback, press the **PLAY** button.

NOTES:

- Every time you press the **STOP** button, the setting will be turned OFF.
- Subtitle can be viewed during this function.
- Picture Control, Black Level and Audio Language setting cannot be changed while using this mode.
- Virtual Surround does not function while using this mode.
- This feature may not work at some point on a disc.
- When using digital audio connection (COAXIAL, OPTICAL or HDMI), the LPCM sound will be output.
- When using the Dialog Speed function with Multi-channel digital outputting, the analog output sound will be fixed at 2 channel.
- When using digital audio connection, only the Dolby Digital sound will be available.

Audio Language

DVD-V DivX®

The DVD player allows you to select a language (if multiple languages are available) during DVD disc playback.

- 1** Press the **AUDIO** button during playback.
- 2** Press the **AUDIO** button repeatedly to select your desired language.

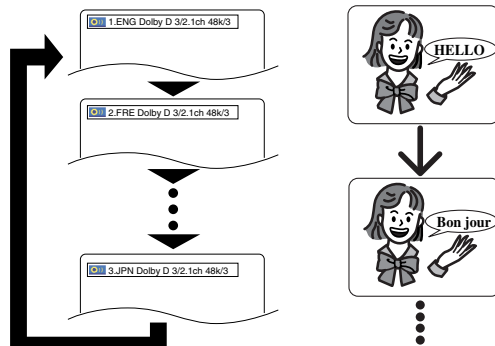

NOTES:

- The sound mode cannot be changed during playback of discs not recorded in double sound.
- Some discs allow to change audio language setting on the disc menu. (Operation varies between discs. Refer to the manual accompanying the disc.)
- For discs with DivX® files, the screen only displays MP3, MP2 or Dolby Digital audio. Other audio sound is not supported.
- Pressing the **AUDIO** button may not work on some DVDs with multiple audio languages (e.g. DVDs which allow to change audio language setting on the disc menu).
- If you choose a language that has a three-letter language code, the code will be displayed every time you change the Audio Language setting. If you choose any other Languages, '---' will be displayed instead (refer to page 32).
- Audio Language selection cannot be made during Dialog Speed.
- If the disc has no audio language, NOT AVAILABLE will be displayed.

Subtitle Language

DVD-V DivX®

The DVD player allows you to select a subtitle language (if multiple languages are available) during DVD playback.

- 1 Press the **SUBTITLE** button during playback.
- 2 Press the **SUBTITLE** button repeatedly to select your desired subtitle language.
 - The selected language will be displayed on the display bar at the top of the screen.
 - Press the **Cursor** buttons (◀ or ▶) to turn on or off subtitles during playback.

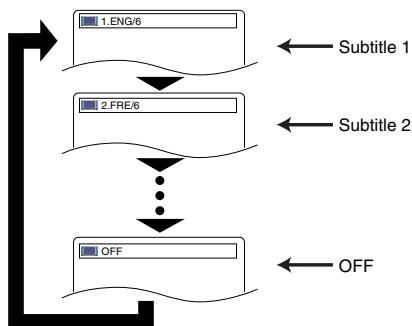

- 3 To turn off subtitles, press the **SUBTITLE** button repeatedly until OFF appears.

NOTES:

- Some discs allow subtitle language setting on the disc menu. (Operation varies between discs. Refer to the manual accompanying the disc.)
- Pressing the **SUBTITLE** button may not work on some DVDs with multiple subtitle languages (e.g. DVDs which allow subtitle language setting on the disc menu).
- If your desired language is not shown after pressing the **SUBTITLE** button several times, the disc does not have subtitles in that language.
- If you choose a language that has a three-letter language code, the code will be displayed every time you change the Subtitle Language setting. If you choose any other Languages, '---' will be displayed instead (refer to page 32).
- If the disc has no subtitle language, NOT AVAILABLE will be displayed.
- For discs with DivX® files, the screen only displays the number of subtitle languages.

Camera Angle

DVD-V

Some DVD discs contain scenes which have been shot simultaneously from various angles. You can change the camera angle when the (📷) mark appears on the screen.

- 1 Press the **ANGLE** button during playback.
 - The selected angle will be displayed on the display bar at the top of the screen.
- 2 Press the **ANGLE** button repeatedly to select your desired angle.

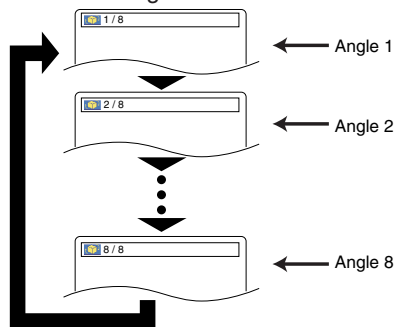

NOTE:

- If the ANGLE ICON setting is OFF in the OTHERS menu, the (📷) will not appear.

Picture Control

DVD-V VCD DivX®

Picture Control adjusts Brightness, Contrast, Color, Gamma Correction and Sharpness of the specific display.

- 1 During playback, press the **MODE** button.
- 2 Press the **Cursor** buttons (▲ or ▼) to switch among items.
- 3 Press the **ENTER** button or the **Cursor** buttons (◀ or ▶) to adjust the selected item to a desired level.
 - -6, -5, -4, -3, -2, -1, 0, +1, +2, +3, +4, +5, +6 can be selected.
- 4 To return to normal playback, press the **RETURN** button.

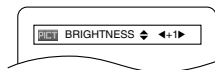

NOTES:

- The default settings for all items in Picture Control are "0".
- The setting display will disappear in 10 seconds of no use.
- This function cannot be used during Dialog Speed (refer to page 26).
- If you return all items to the default settings, select "INITIALIZE" at step 2.

DISC PLAYBACK

Stereo Sound Mode

VCD CD

- 1 Press the **AUDIO** button repeatedly during playback to select your desired sound mode.

STEREO - both right and left channels are active (stereo)

L-ch - only left channel is active

R-ch - only right channel is active

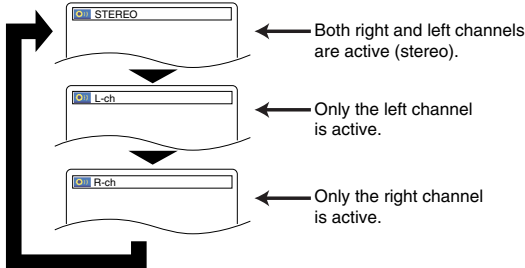

NOTE:

- The STEREO can only be output when playing back DTS CD.

Virtual Surround

DVD-V VCD CD MP3 WMA

You can enjoy stereo phonic virtual space through your existing 2 channel stereo system.

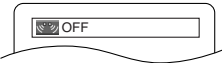
- 1 During playback, press the **MODE** button repeatedly until the Virtual Surround setting appears. 
- 2 Press the **ENTER** button to set it 1(Natural effect), 2(Emphasized effect) or OFF.
- 3 Press the **RETURN** button to exit.

NOTES:

- Set Virtual Surround to OFF or lower the volume if the sound is distorted.
- Virtual Surround will not be effective if the sound mode is set to something other than STEREO (for Audio CD or Video CD playback only).
- This function cannot be used during Dialog Speed (refer to page 26).

Black Level Setting

DVD-V VCD DivX®

Adjust the Black Level Setting to make the black parts of the picture as bright as you prefer.

- 1 During playback, press the **MODE** button repeatedly until Black Level setting appears. 
- 2 Press the **ENTER** button to switch ON or OFF.
ON (Default) : Makes the dark parts brighter.
OFF : Shows the original picture as recorded.
- 3 Press the **RETURN** button to exit.

NOTE:

- This function cannot be used during Dialog Speed (refer to page 26).

DVD SETUP

In Setup menu, QUICK mode, CUSTOM mode and INITIALIZE mode are available (refer to pages 29-31). QUICK mode consists of the setting menus frequently used, and they are accompanied with **QUICK** mark. You can make all settings in CUSTOM mode.

Language Setting

Language options are not available with some DVD or DivX®.

- 1 Press the **SETUP** button in stop mode.
- 2 Press the **Cursor** buttons (◀ or ▶) to select **CUSTOM**, then press the **ENTER** button.
 - The custom mode will appear.
- 3 Press the **Cursor** buttons (◀ or ▶) to select **LANGUAGE**, then press the **ENTER** button to confirm.
- 4 Press the **Cursor** buttons (▲ or ▼) to select an item, then press the **ENTER** button.

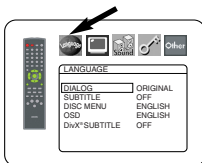

DIALOG (Default : ORIGINAL)

- Sets the audio language.

SUBTITLE (Default : OFF)

- Sets the subtitle language.

DISC MENU (Default : ENGLISH)

- Sets the language for DVD Menu.

OSD (Default : ENGLISH) **QUICK**

- Sets the language for the On-Screen display.

DivX SUBTITLE (Default: OFF)

- Sets the DivX® subtitle language.

- 5 Press the **Cursor** buttons (▲ or ▼) to select a setting, then press the **ENTER** button.
 - If OTHER is selected in the DIALOG, SUBTITLE or DISC MENU, press four-digit number to enter the code for the desired language (refer to the "Language Code List" on page 32).
 - Only the languages supported by the disc can be selected.
- 6 Press the **SETUP** button to exit and activate the new settings.

NOTE:

- Language Setting for DIALOG and SUBTITLE may not be available with some discs. Then use the **AUDIO** and **SUBTITLE** buttons. Details are on pages 26-27.

Display Setting

You can change certain aspects of the DVD display screens, still mode setting, Progressive and HDMI settings.

- 1 Press the **SETUP** button in stop mode.
- 2 Press the **Cursor** buttons (◀ or ▶) to select **CUSTOM**, then press the **ENTER** button.
 - The custom mode will appear.
- 3 Press the **Cursor** buttons (◀ or ▶) to select **DISPLAY**, then press the **ENTER** button to confirm.
- 4 Press the **Cursor** buttons (▲ or ▼) to select an item, then press the **ENTER** button.



TV ASPECT (Default : 4:3 LETTER BOX) **QUICK**

- Press the **Cursor** buttons (▲ or ▼) for an item selection, then press the **ENTER** button.
- Select 4:3 LETTER BOX for a black bars appears on top and bottom of the screen.
- Select 4:3 PAN & SCAN for a full height picture with both sides trimmed.
- Select 16:9 WIDE if a wide-screen TV is connected to the DVD player.
- Select 4:3 SQUEEZE when the TV screen is too large horizontally at 16:9 WIDE setting and when it is impossible to adjust the screen size using the TV's controls.

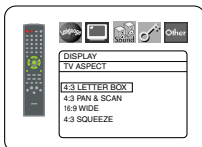

STILL MODE (Default : AUTO)

- Press the **Cursor** buttons (▲ or ▼) for an item selection (AUTO, FIELD, or FRAME), then press the **ENTER** button.
- This function allows you to adjust picture resolution and quality in still mode.
- An individual picture on TV screen is called as "frame", which consists of two separate images called as "field". Some pictures may be blurred at the AUTO setting in still mode due to their data characteristics.
- AUTO: Automatically selects the best resolution setting (FRAME or FIELD) based on the data characteristics of the pictures.
- FIELD: Select FIELD when the pictures are still unstable even if AUTO is selected. FIELD stabilizes the pictures, although the picture quality may become coarse due to the limited amount of data.
- FRAME: Select FRAME to display relatively motionless pictures in higher resolution. FRAME improves the picture quality, although it may destabilize the pictures due to simultaneous output of two field data.

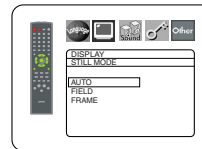

PROGRESSIVE

(Default: OFF) **QUICK**

- Press the **ENTER** button repeatedly to turn ON or OFF.
- The setting will be effective when you exit the setup screen by pressing **SETUP**.
- When PROGRESSIVE is ON, P.SCAN appears on the DVD player's display after you exit the setup screen.
- Refer to page 13 for more details.

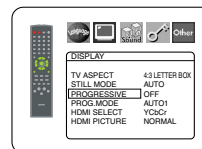

PROG.MODE (Default: AUTO1)

- Press the **Cursor** buttons (▲ or ▼) to select a setting (AUTO1, AUTO2 or VIDEO), then press the **ENTER** button.
- For HDMI or Component Video connector, this function allows you to select the image output, depending on the base material (video or film) of the recorded DVD images, when PROGRESSIVE is ON.
- AUTO1: Automatically selects the best image output (AUTO2 or VIDEO) based on the information of data stream.
- AUTO2: A combination of the top and bottom fields is output as one-frame image.
- VIDEO: Either of top or bottom field is output for one-frame image.

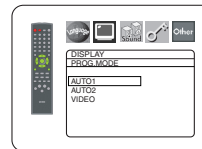

HDMI SELECT (Default: YCbCr)

- Select an HDMI output mode between YCbCr and RGB.
- When the connected equipment is not compatible with YCbCr, HDMI signal is output as RGB regardless of the setting.

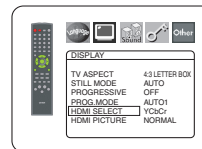

HDMI PICTURE (Default: NORMAL)

- Select a HDMI picture mode between NORMAL and ENHANCED.
- Select ENHANCED if the black-white contrast is not clear.
- This setting is effective only for HDMI RGB output.

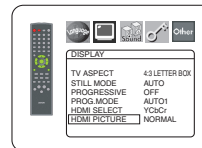

- 5 Press the **SETUP** button to exit and activate the new settings.

Audio Setting

You can change some Audio settings. It only affects during the playback of DVD discs.

- 1** Press the **SETUP** button in stop mode.
- 2** Press the **Cursor** buttons (◀ or ▶) to select **CUSTOM**, then press the **ENTER** button.
 - The custom mode will appear.
- 3** Press the **Cursor** buttons (◀ or ▶) to select **AUDIO**, then the **ENTER** button to confirm.
- 4** Press the **Cursor** buttons (▲ or ▼) button to select an item, then press the **ENTER** button.



DRC (Dynamic Range Control) (Default : ON)

- DRC function compresses the range of sound volume.
- DRC function is available only on the discs that are recorded in the Dolby Digital format.



LPCM SELECT (Default : OFF)

- Set to ON when outputting in 48kHz.
- This function is available only on digital outputting of a disc recorded in 96kHz.
- This function is not effective for the HDMI sound output.



When playing disc with copyright protection

- The sound will be down sampled at 48kHz, even if you set to OFF.

DOLBY DIGITAL (Default: BITSTREAM) QUICK

- Set to BITSTREAM when the player is connected to a Dolby Digital decoder.
- This function is effective only for the COAXIAL, OPTICAL and HDMI connections.



BITSTREAM:
 DOLBY DIGITAL signals are output as Bitstream.
 • For HDMI connection, if the connected equipment is not compatible with the Dolby Digital BITSTREAM, the signals are output as PCM regardless of the setting.

PCM: Convert Dolby Digital to PCM.

DTS (Default : BITSTREAM) QUICK

- Set to BITSTREAM when the unit is connected to a DTS decoder.

BITSTREAM:
 DTS signals are output as Bitstream.
 • For HDMI connection, if the connected equipment is not compatible with the DTS Bitstream, the signals are not output regardless of the setting.



OFF:
 No DTS sound will be output
 • DTS sound is bitstream output only, from digital audio outputs.

AUDIO MODE (Default: HDMI)

- Set to HDMI when outputting the HDMI sound.
- Set to ANALOG when not outputting the HDMI sound.



- 5** Press the **SETUP** button to exit and activate the new settings.

Ratings Control

Ratings Control allows you to set a limit, which prevents your children from viewing inappropriate materials on DVDs. A four-digit password that you establish will give you the control.

RATING LEVEL

You can set a viewing limit through Rating Level. Playback of the discs will stop if the disc's general rating exceeds the limit you set.

- 1** Press the **SETUP** button in stop mode.
- 2** Press the **Cursor** buttons (◀ or ▶) to select **CUSTOM**, then press the **ENTER** button.
- 3** Press the **Cursor** buttons (◀ or ▶) to select **RATINGS**, then press the **ENTER** button.
- 4** Press the **Numeric** buttons to enter your four-digit password.
 - When doing this for the first time, enter any four-digit number by pressing the **Numeric** buttons (except for 4737), then press the **ENTER** button. That number will be used as the password from the second time onward. Record your password in case you forget it.
- 5** Press the **Cursor** buttons (▲ or ▼) to select **RATING LEVEL**, then press the **ENTER** button.
- 6** Press the **Cursor** buttons (▲ or ▼) to select a desired level, then press the **ENTER** button.
- 7** Press the **SETUP** button to exit and activate the new settings.

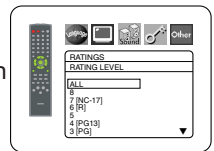
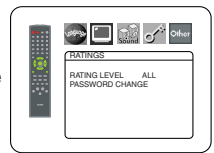

NOTE:

- This function may not work on some DVDs. Be sure if the RATINGS operates in the way you have set.

To Change the Password:

- 1) Follow the steps **1** to **4** above.
- 2) Press the **Cursor** buttons (▲ or ▼) to select **PASSWORD CHANGE**, then press the **ENTER** button.
- 3) Enter a new four-digit password, then press the **ENTER** button.
- 4) Press the **SETUP** button to exit.

IF YOU FORGET THE PASSWORD

- 1** Press **4, 7, 3, 7** at step **4**.
 - Password will be cleared and rating level will be set to ALL.
- 2** Repeat steps **4** to **7** to re-establish the parental lock.

CONTROL LEVELS

- **ALL**
 Parental lock is canceled.
- **Level 8**
 DVD software of any grade (adult/general/children) can be played back.
- **Levels 7 to 2**
 Only DVD software intended for general use and children can be played back.
- **Level 1**
 Only DVD software intended for children can be played back, with those intended for adult and general use prohibited.

Others Setting

This function allows you to adjust Angle Icon availability, Auto Power off, brightness of the Player's display panel, slide show mode and to obtain DivX® registration code.

- 1 Press the **SETUP** button in stop mode.
- 2 Press the **Cursor** buttons (◀ or ▶) to select **CUSTOM**, then press **ENTER**.
 - The custom mode will appear.
- 3 Press the **Cursor** buttons (◀ or ▶) to select **Other**, then press the **ENTER** button to confirm.
- 4 Press the **Cursor** buttons (▲ or ▼) to select an item, then press **ENTER**.



ANGLE ICON (Default : ON)

- Press the **ENTER** button repeatedly to turn ON or OFF.

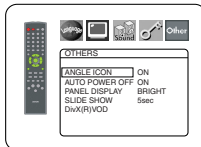

AUTO POWER OFF (Default : ON)

- Press the **ENTER** button repeatedly to turn ON or OFF.
- It will turn off the DVD player automatically after 30 minutes of no use.



PANEL DISPLAY (Default : BRIGHT)

- Press the **Cursor** buttons (▲ or ▼) to select a setting (BRIGHT, DIMMER and AUTO), then press the **ENTER** button.
- When AUTO is selected, the display dims only during playback.

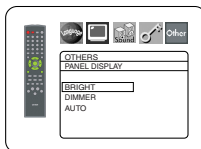

SLIDE SHOW (Default : 5sec)

- This adjusts the playback speed of the JPEG SLIDE SHOW.
- Press the **Cursor** buttons (▲ or ▼) to select between 5 sec and 10 sec, then press the **ENTER** button.

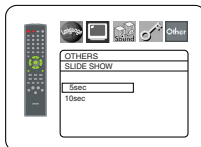

DivX(R)VOD

- This player allows you to use the DivX® Video-On-Demand (VOD) services. You can play back the files purchased or rental from the VOD services. You need to have a registration code to purchase or rental VOD files. Please visit www.divx.com/vod for more details.

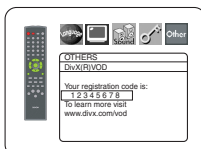

- 5 Press the **SETUP** button to exit.

NOTES:

- You cannot play back the DivX® VOD files obtained with different registration codes on this player.
- You cannot play back the DivX® VOD files, of which rental period has been expired. In such case, press the **MENU** button and select other files that can be played back.
- Some DivX® VOD files are restricted with the limited playable times (you cannot play them back beyond the limit). If your DivX® VOD file has such limit, the playback confirmation screen will appear. Use the **Cursor** buttons (◀ or ▶) to select YES if you want to play back the file, or to select NO if you do not wish to play it back. Then, press the **ENTER** button to confirm the selection.
- Please send your inquiries regarding the VOD files to DivX®, Inc.

Reset to the Default Settings (except for Ratings Control)

This allows you to return all selections of SETUP (except for RATINGS) to their default settings.

- 1 Press the **SETUP** button in stop mode.
- 2 Press the **Cursor** buttons (◀ or ▶) to select **INITIALIZE**, then press the **ENTER** button.
- 3 Press the **Cursor** buttons (▲ or ▼) to select **YES**, then press the **ENTER** button.
- 4 Press the **SETUP** button to exit.

NOTE:

- If you do not wish to initialize, select **NO** at step 3.

Language Code List

Language	Code	Language	Code	Language	Code	Language	Code
A-B							
Abkhazian	4748	Frisian	5271	Malay	5965	Somali	6561
Afar	4747	Galician	5358	Malayalam	5958	Spanish [SPA]	5165
Afrikaans	4752	Georgian	5747	Maltese	5966	Sundanese	6567
Albanian	6563	German [GER]	5051	Maori	5955	Swahili	6569
Amharic	4759	Greek [GRE]	5158	Marathi	5964	Swedish [SWE]	6568
Arabic	4764	Greenlandic	5758	Moldavian	5961	T	
Armenian	5471	Guarani	5360	Mongolian	5960	Tagalog	6658
Assamese	4765	Gujarati	5367	Nauru	6047	Tajik	6653
Aymara	4771	Hausa	5447	Nepali	6051	Tamil	6647
Azerbaijani	4772	Hebrew	5569	Norwegian [NOR]	6061	Tatar	6666
Bashkir	4847	Hindi	5455	O-R		Telugu	6651
Basque	5167	Hungarian [HUN]	5467	Occitan	6149	Thai	6654
Bengali; Bangla	4860	I-K		Oriya	6164	Tibetan	4861
Bhutani	5072	Icelandic [ICE]	5565	Oromo (Afan)	6159	Tigrinya	6655
Bihari	4854	Indonesian	5560	Panjabi	6247	Tonga	6661
Bislama	4855	Interlingua	5547	Pashto; Pushto	6265	Tsonga	6665
Breton	4864	Interlingue	5551	Persian	5247	Turkish [TUR]	6664
Bulgarian	4853	Inupiak	5557	Polish [POL]	6258	Turkmen	6657
Burmese	5971	Irish [IRI]	5347	Portuguese [POR]	6266	Twi	6669
Byelorussian	4851	Italian [ITA]	5566	Quechua	6367	U-Z	
C-E		Japanese [JPN]	5647	Rhaeto-Romance	6459	Ukrainian	6757
Cambodian	5759	Javanese	5669	Romanian [RUM]	6461	Urdu	6764
Catalan	4947	Kannada	5760	Russian [RUS]	6467	Uzbek	6772
Chinese [CHI]	7254	Kashmiri	5765	S		Vietnamese	6855
Corsican	4961	Kazakh	5757	Samoan	6559	Volapuk	6861
Croatian	5464	Kinyarwanda	6469	Sangho	6553	Welsh	4971
Czech [CZE]	4965	Kirghiz	5771	Sanskrit	6547	Wolof	6961
Danish [DAN]	5047	Kirundi	6460	Scots Gaelic	5350	Xhosa	7054
Dutch [DUT]	6058	Korean [KOR]	5761	Serbian	6564	Yiddish	5655
English [ENG]	5160	Kurdish	5767	Serbo-Croatian	6554	Yoruba	7161
Esperanto	5161	L-N		Sesotho	6566	Zulu	7267
Estonian	5166	Laothian	5861	Setswana	6660		
F-H		Latin	5847	Shona	6560		
Faroese	5261	Latvian; Lettish	5868	Sindhi	6550		
Fiji	5256	Lingala	5860	Singhalese	6555		
Finnish [FIN]	5255	Lithuanian	5866	Siswat	6565		
French [FRE]	5264	Macedonian	5957	Slovak	6557		
		Malagasy	5953	Slovenian	6558		

If you choose a language that has a three-letter language code (written in bracket), the code will be displayed every time you change the Audio or Subtitle Language setting on pages 26-27. If you choose any other languages, '---' will be displayed instead.

TROUBLESHOOTING GUIDE

If the DVD player does not perform properly when operated as instructed in this Operating Instruction, check the player, consulting the following checklist.

Problem	Solution	Page
No power	<ul style="list-style-type: none"> – Check if the AC power cord is properly connected. – Unplug the AC power cord once, and wait for 5-10 seconds and then plug it in again. 	— —
No sound or picture	<ul style="list-style-type: none"> – Check if the TV is turned on. – Check the video connection and HDMI connection. – Check the VIDEO/AUDIO cable connections. – Check if the PROGRESSIVE mode is set correctly. 	— 15, 16 14-16 13, 29
Distorted picture	<ul style="list-style-type: none"> – Sometimes a small amount of picture distortion may appear. This is not a malfunction. – Connect the player directly to the TV. 	— 15, 16
Completely distorted picture or black/white picture with DVD	<ul style="list-style-type: none"> – Connect the DVD player directly to the TV. – Make sure the disc is compatible with the DVD player. 	15, 16 6
No sound or distorted sound	<ul style="list-style-type: none"> – Adjust the volume. – Check that the speakers are connected correctly. 	— 14
No audio at digital output	<ul style="list-style-type: none"> – Check the digital connections. – Check the audio settings. 	14, 16 30
No image from HDMI connection	<ul style="list-style-type: none"> – Check the HDMI connection. (Check the status of the HDMI related indications.) – Check whether the connected monitor equipment or other equipment supports HDCP. (This player will not output a video signal unless the other equipment supports HDCP.) – Connect the DVD player to the display device using the Audio/Video cables (supplied) and check the setting of HDMI. – Check whether the output format of this player (HDMI FORMAT) matches the supported input format of other connected equipment. 	16, 17 16 16-17 16
Picture freezes momentarily during playback	<ul style="list-style-type: none"> – Check the disc for fingerprints/dust and clean with a soft cloth wiping from center to edge. – Clean the disc. 	34 34
Disc cannot be played	<ul style="list-style-type: none"> – Clean the disc. – Ensure the disc label is facing up. – Check if the disc is defective by trying another disc. – Cancel Ratings control or change the control level. – Insert a correct disc that plays on this player. 	34 17 — 30 6
No return to start-up screen when disc is removed	<ul style="list-style-type: none"> – Reset the player by turning it off, then on again. 	—
The player does not respond to the remote control	<ul style="list-style-type: none"> – Aim the remote control directly at the sensor on the front of the player. – Reduce the distance to the player. – Replace the batteries in the remote control. – Re-insert the batteries with their polarities (+/– signs) as indicated. 	12 — 12 12
Buttons do not work or player stops responding	<ul style="list-style-type: none"> – To completely reset the player, unplug the AC cord from responding the AC outlet for 5-10 seconds. 	—
Player does not respond to some operating commands during playback	<ul style="list-style-type: none"> – Operations may not be permitted by the disc. Refer to the instructions of the disc. 	6
DVD player cannot read CDs/DVDs	<ul style="list-style-type: none"> – Use a commercially available CD/DVD cleaner to clean the lens before sending the DVD player for repair. 	34
Angle does not switch	<ul style="list-style-type: none"> – The angle cannot be switched for DVDs which do not contain multiple angles. In some cases multiple angles are only recorded for specific scenes. 	27
Playback does not start when the title is selected	<ul style="list-style-type: none"> – Check the RATINGS setting. 	30
The password for rating level has been forgotten	<ul style="list-style-type: none"> – Enter the default password “4737”, then your forgotten password will be cleared. 	30

NOTES:

- Some functions are not available in specific modes, but this is not a malfunction. Read the description in these Operating Instructions for details on correct operations.
- Playback from a desired track and random playback are not available during program playback.
- Some functions are prohibited on some discs.

SPECIFICATIONS

SIGNAL SYSTEM

NTSC color

APPLICABLE DISCS

- (1) DVD-Video Discs
1-layer 12cm single-sided discs, 2-layer 12cm single-sided discs, 2-layer 12cm double-sided discs (1 layer per side)
1-layer 8cm single-sided discs, 2-layer 8cm single-sided discs, 2-layer 8cm double-sided discs (1 layer per side)
- (2) DVD-R/DVD-RW
- (3) Compact discs (Audio CD, Video CD)
12cm discs, 8cm discs
- (4) CD-R/CD-RW

S-VIDEO OUTPUT

Y output level: 1Vp-p (75Ω/ohms)
C output level: 0.286Vp-p
Output connectors: S connectors, 1 set

VIDEO OUTPUT

Output level: 1Vp-p (75Ω/ohms)
Output connector: Pin jacks, 1 set

COMPONENT OUTPUT

Y output level: 1Vp-p (75Ω/ohms)
PB/CB output level: 0.648Vp-p (75Ω/ohms)
PR/CR output level: 0.648Vp-p (75Ω/ohms)
Output connector: Pin jacks, 1 set

HDMI OUTPUT

HDMI jack, 1 set

AUDIO OUTPUT

Output level: 2Vrms
2 channel (L, R) output connector: Pin jack, 1 set

AUDIO OUTPUT PROPERTIES

- (1) Frequency response
1 DVDs (linear PCM) : 4Hz to 22kHz (48kHz sampling)
: 4Hz to 44kHz (96kHz sampling)
2 CDs : 4Hz to 20kHz
- (2) S/N ratio : 115dB
- (3) Total harmonic distortion : 1kHz CD: 0.003%
- (4) Dynamic range : DVD: 100dB
CD: 98dB

DIGITAL AUDIO OUTPUT

Optical digital output: Optical connector, 1 set
Coaxial digital output: Pin jack, 1 set

POWER SUPPLY

AC 120V, 60Hz

POWER CONSUMPTION

10W (Standby: 0.8W)

MAXIMUM EXTERNAL DIMENSIONS

W: 17-3/32" (435mm)
H: 4-3/32" (104mm)
D: 14-9/16" (370mm)
(including protruding parts)

MASS

9.92 lbs (4.5 kg)

REMOTE CONTROL UNIT

RC-1040
Infrared pulse type
Supply: DC 3V, 2 R6P/AA batteries

MAINTENANCE

Cleaning the Cabinet

- Use a soft cloth slightly moistened with a mild detergent solution. Do not use a solution containing alcohol, spirits, ammonia or abrasives.

Cleaning Discs

- When a disc becomes dirty, clean it with a cleaning cloth. Wipe the disc from the center out. Do not wipe in a circular motion.
- Do not use solvents such as benzene, thinner, commercially available cleaners, detergent, abrasive cleaning agents or antistatic spray intended for analog records.

Cleaning the disc lens

- If the player still does not perform properly when it is operated while referring to the relevant sections and to "TROUBLESHOOTING GUIDE" in this Operating Instruction, the laser optical pickup unit may be dirty. Consult your dealer or an Authorized Service Center for inspection and cleaning of the laser optical pickup unit.

Disc Handling

- Use discs which have the following logos on them.
- Handle the discs so that fingerprints and dust do not adhere to the surfaces of the discs.
- Always store the disc in its protective case when it is not used.
- Note that discs with special shapes (heart-shaped discs, octagonal discs, etc.) cannot be played on this product. Do not attempt to play such discs, as they may damage the player.



MP3



Printed in China
00D 511 4593 107

DENON
TOKYO, JAPAN
www.denon.com

Denon Brand Company, D&M Holdings Inc.
1VMN23562A
E8701UD ****

Free Manuals Download Website

<http://myh66.com>

<http://usermanuals.us>

<http://www.somanuals.com>

<http://www.4manuals.cc>

<http://www.manual-lib.com>

<http://www.404manual.com>

<http://www.luxmanual.com>

<http://aubethermostatmanual.com>

Golf course search by state

<http://golfingnear.com>

Email search by domain

<http://emailbydomain.com>

Auto manuals search

<http://auto.somanuals.com>

TV manuals search

<http://tv.somanuals.com>