

DENON

AV SURROUND RECEIVER

AVR-587

OPERATING INSTRUCTIONS

☐ SAFETY PRECAUTIONS



CAUTION
RISK OF ELECTRIC SHOCK
DO NOT OPEN



CAUTION:
TO REDUCE THE RISK OF ELECTRIC SHOCK, DO NOT REMOVE COVER (OR BACK). NO USER-SERVICEABLE PARTS INSIDE. REFER SERVICING TO QUALIFIED SERVICE PERSONNEL.



The lightning flash with arrowhead symbol, within an equilateral triangle, is intended to alert the user to the presence of uninsulated "dangerous voltage" within the product's enclosure that may be of sufficient magnitude to constitute a risk of electric shock to persons.



The exclamation point within an equilateral triangle is intended to alert the user to the presence of important operating and maintenance (servicing) instructions in the literature accompanying the appliance.

WARNING:
TO REDUCE THE RISK OF FIRE OR ELECTRIC SHOCK, DO NOT EXPOSE THIS APPLIANCE TO RAIN OR MOISTURE.

SAFETY INSTRUCTIONS

1. Read Instructions – All the safety and operating instructions should be read before the product is operated.
2. Retain Instructions – The safety and operating instructions should be retained for future reference.
3. Heed Warnings – All warnings on the product and in the operating instructions should be adhered to.
4. Follow Instructions – All operating and use instructions should be followed.
5. Cleaning – Unplug this product from the wall outlet before cleaning. Do not use liquid cleaners or aerosol cleaners.
6. Attachments – Do not use attachments not recommended by the product manufacturer as they may cause hazards.
7. Water and Moisture – Do not use this product near water – for example, near a bath tub, wash bowl, kitchen sink, or laundry tub; in a wet basement; or near a swimming pool; and the like.
8. Accessories – Do not place this product on an unstable cart, stand, tripod, bracket, or table. The product may fall, causing serious injury to a child or adult, and serious damage to the product. Use only with a cart, stand, tripod, bracket, or table recommended by the manufacturer, or sold with the product. Any mounting of the product should follow the manufacturer's instructions, and should use a mounting accessory recommended by the manufacturer.
9. A product and cart combination should be moved with care. Quick stops, excessive force, and uneven surfaces may cause the product and cart combination to overturn.
10. Ventilation – Slots and openings in the cabinet are provided for ventilation and to ensure reliable operation of the product and to protect it from overheating, and these openings must not be blocked or covered. The openings should never be blocked by placing the product on a bed, sofa, rug, or other similar surface. This product should not be placed in a built-in installation such as a bookcase or rack unless proper ventilation is provided or the manufacturer's instructions have been adhered to.
11. Power Sources – This product should be operated only from the type of power source indicated on the marking label. If you are not sure of the type of power supply to your home, consult your product dealer or local power company. For products intended to operate from battery power, or other sources, refer to the operating instructions.
12. Grounding or Polarization – This product may be equipped with a polarized alternating-current line plug (a plug having one blade wider than the other). This plug will fit into the power outlet only one way. This is a safety feature. If you are unable to insert the plug fully into the outlet, try reversing the plug. If the plug should still fail to fit, contact your electrician to replace your obsolete outlet. Do not defeat the safety purpose of the polarized plug.



13. Power-Cord Protection – Power-supply cords should be routed so that they are not likely to be walked on or pinched by items placed upon or against them, paying particular attention to cords at plugs, convenience receptacles, and the point where they exit from the product.
15. Outdoor Antenna Grounding – If an outside antenna or cable system is connected to the product, be sure the antenna or cable system is grounded so as to provide some protection against voltage surges and built-up static charges. Article 810 of the National Electrical Code, ANSI/NFPA 70, provides information with regard to proper grounding of the mast and supporting structure, grounding of the lead-in wire to an antenna discharge unit, size of grounding conductors, location of antenna-discharge unit, connection to grounding electrodes, and requirements for the grounding electrode. See Figure A.
16. Lightning – For added protection for this product during a lightning storm, or when it is left unattended and unused for long periods of time, unplug it from the wall outlet and disconnect the antenna or cable system. This will prevent damage to the product due to lightning and power-line surges.
17. Power Lines – An outside antenna system should not be located in the vicinity of overhead power lines or other electric light or power circuits, or where it can fall into such power lines or circuits. When installing an outside antenna system, extreme care should be taken to keep from touching such power lines or circuits as contact with them might be fatal.
18. Overloading – Do not overload wall outlets, extension cords, or integral convenience receptacles as this can result in a risk of fire or electric shock.
19. Object and Liquid Entry – Never push objects of any kind into this product through openings as they may touch dangerous voltage points or short-out parts that could result in a fire or electric shock. Never spill liquid of any kind on the product.
20. Servicing – Do not attempt to service this product yourself as opening or removing covers may expose you to dangerous voltage or other hazards. Refer all servicing to qualified service personnel.
21. Damage Requiring Service – Unplug this product from the wall outlet and refer servicing to qualified service personnel under the following conditions:
 - a) When the power-supply cord or plug is damaged,
 - b) If liquid has been spilled, or objects have fallen into the product,
 - c) If the product has been exposed to rain or water,
 - d) If the product does not operate normally by following the operating instructions. Adjust only those controls that are covered by the operating instructions as an improper adjustment of other controls may result in damage and will often require extensive work by a qualified technician to restore the product to its normal operation,
 - e) If the product has been dropped or damaged in any way, and
 - f) When the product exhibits a distinct change in performance – this indicates a need for service.
22. Replacement Parts – When replacement parts are required, be sure the service technician has used replacement parts specified by the manufacturer or have the same characteristics as the original part. Unauthorized substitutions may result in fire, electric shock, or other hazards.
23. Safety Check – Upon completion of any service or repairs to this product, ask the service technician to perform safety checks to determine that the product is in proper operating condition.
24. Wall or Ceiling Mounting – The product should be mounted to a wall or ceiling only as recommended by the manufacturer.
25. Heat – The product should be situated away from heat sources such as radiators, heat registers, stoves, or other products (including amplifiers) that produce heat.

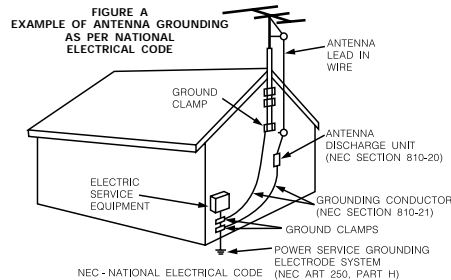

FCC INFORMATION (For US customers)

1. PRODUCT

This product complies with Part 15 of the FCC Rules. Operation is subject to the following two conditions: (1) this product may not cause harmful interference, and (2) this product must accept any interference received, including interference that may cause undesired operation.

2. IMPORTANT NOTICE: DO NOT MODIFY THIS PRODUCT

This product, when installed as indicated in the instructions contained in this manual, meets FCC requirements. Modification not expressly approved by DENON may void your authority, granted by the FCC, to use the product.

3. NOTE







This product has been tested and found to comply with the limits for a Class B digital device, pursuant to Part 15 of the FCC Rules. These limits are designed to provide reasonable protection against harmful interference in a residential installation.

This product generates, uses and can radiate radio frequency energy and, if not installed and used in accordance with the instructions, may cause harmful interference to radio communications. However, there is no guarantee that interference will not occur in a particular installation. If this product does cause harmful interference to radio or television reception, which can be determined by turning the product OFF and ON, the user is encouraged to try to correct the interference by one or more of the following measures:

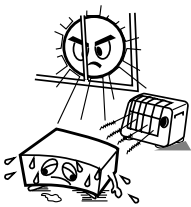
- Reorient or relocate the receiving antenna.
- Increase the separation between the equipment and receiver.
- Connect the product into an outlet on a circuit different from that to which the receiver is connected.
- Consult the local retailer authorized to distribute this type of product or an experienced radio/TV technician for help.

This Class B digital apparatus complies with Canadian ICES-003.
Cet appareil numérique de la classe B est conforme à la norme NMB-003 du Canada.

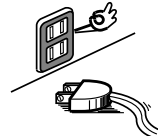
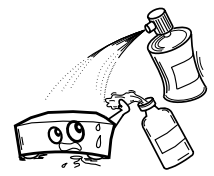
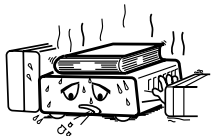
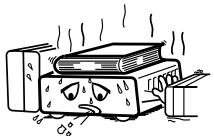
NOTE ON USE

 <ul style="list-style-type: none"> • Avoid high temperatures. Allow for sufficient heat dispersion when installed in a rack. 	 <ul style="list-style-type: none"> • Keep the apparatus free from moisture, water, and dust. 	 <ul style="list-style-type: none"> • Do not let foreign objects into the apparatus.
 <ul style="list-style-type: none"> • Handle the power cord carefully. Hold the plug when unplugging the cord. 	 <ul style="list-style-type: none"> • Unplug the power cord when not using the apparatus for long periods of time. 	 <ul style="list-style-type: none"> • Do not let insecticides, benzene, and thinner come in contact with the apparatus.
 <ul style="list-style-type: none"> • Do not obstruct the ventilation holes. 	<p>* (For apparatuses with ventilation holes)</p>  <ul style="list-style-type: none"> • Do not obstruct the ventilation holes. 	 <ul style="list-style-type: none"> • Never disassemble or modify the apparatus in any way.

Thank you for choosing the DENON AVR-587 AV Surround Receiver. This remarkable component has been engineered to provide superb surround sound listening with home theater sources such as DVD, as well as providing outstanding high fidelity reproduction of your favorite music sources.

As this product is provided with an immense array of features, we recommend that before you begin hookup and operation that you review the contents of this manual before proceeding.

Contents

Getting Started		Connecting Other Sources		Basic Operation	
Accessories	2	Cable indications	10	Playing the input source	25
Before using	2	Connecting a TV/DBS tuner	11	Turning the sound off temporarily (MUTING)	26
Cautions on installation	3	Connecting a video camera or video game	11	Listening over headphones	26
About the remote control unit	3	Connecting the external inputs (EXT. IN) terminals	11	Switching the front speakers	26
Inserting the batteries	3	Connecting a CD player	12	Checking the currently playing program source, etc.	26
Operating range of the remote control unit	3	Connecting a tape deck, CD recorder or MD recorder	12	Switching the brightness of the display	26
Part names and functions		Connecting a VCR	12	Using the surround modes	
Front panel	4	Connecting the antenna terminals	13	Types of surround modes and their features	26, 27
Display	4	Connecting the XM terminal	13	Selecting the play mode (DIRECT/STEREO)	27
Rear panel	5	Connecting the iPod®	14	Selecting the Dolby Digital and DTS Surround mode	
Remote control unit	5, 6	Connecting the MULTI ZONE terminals		(only with digital input)	28
		ZONE2 speaker out connections	14	Selecting the Dolby Pro Logic IIx (Pro Logic II) mode	29
		Connecting the power supply cord	15	Selecting the DTS NEO:6 mode	30
				Selecting the NEURAL SURROUND mode	30
				Surround modes and parameters	31 ~ 33
				Using the DENON original surround modes	
				Types of surround modes and their features	34
				Selecting the DSP surround simulation	35
				Setting the tone control	36
				Adjusting the speaker volume	36
				Listening to the radio	
				Auto preset memory	36
				Auto tuning	37
				Manual tuning	37
				Preset memory	37
				Recalling preset stations	37
				XM Satellite Radio	38
				Checking the XM signal strength and Radio ID	38
				Channel selection	38
				Category search	38
Easy Operation		System Setup			
Speaker layout [Basic layout]	6	System setup items and default values	16, 17		
Speaker connections	7	Navigating through the System Setup items	18		
Connecting a DVD player and monitor	8	About the front display	18		
Before operating	9	Speaker Setup			
Playing the input source	9	Setting the Speaker Configuration	19		
		Setting the Subwoofer Mode Setup	19		
		Setting the Distance	20		
		Setting the Crossover Frequency	20		
		Setting the Test Tone	21		
		Input Setup			
		Setting the Digital In Assignment	21		
		Setting the iPod Assignment	22		
		Setting the EXT. IN Subwoofer Level	22		
		Setting the Auto Preset Memory	22		
		Option Setup			
		Setting the Power Amplifier Assignment	23		
		Setting the Volume Control	23		
		Setting the Auto Surround Mode	24		

Advanced Operation	
Night mode	39
User mode function	
Storing the settings in the memory	39
Calling the settings out	39
Combining the currently playing sound with the desired image (VIDEO SELECT function)	
39	
Personal memory plus function	
39	
Playing the iPod®	
40	
Listening to music in the Browse mode	40
Viewing still pictures and videos (only for iPods equipped with the slideshow / video function)	41
Disconnecting the iPod	41
Multi zone music entertainment system	
42	
Remote control unit operations during multi-source playback (selecting the source)	42
Recording the program source (recording the source currently being monitored)	
43	
About the memory functions	
43	
Initialization of the microprocessor (Reset)	
43	

Operating the remote control unit	
Operating DENON audio components	44
Setting the preset memory function	44
Operating a component stored in the preset memory	45 ~ 47
Setting the punch through function	48

Additional Information	49, 50
-------------------------------------	--------

Troubleshooting	51
------------------------------	----

Specifications	52
-----------------------------	----

List of preset codes	End of this manual
-----------------------------------	--------------------

Getting Started

Accessories

Check that the following parts are attached in addition to the main unit:

① Operating instructions	1
② Warranty (for North America model only)	1
③ Service station list	1
④ Remote control unit (RC-1048)	1
⑤ R6P/AA batteries	2
⑥ AM loop antenna	1
⑦ FM indoor antenna	1

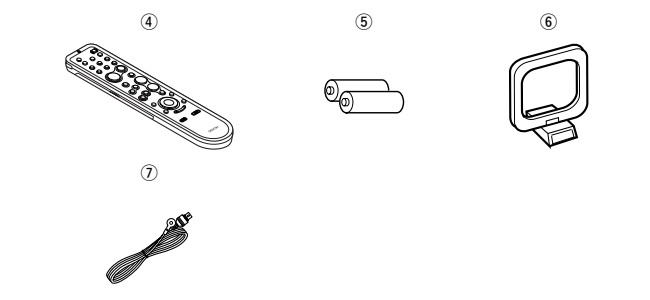

Before using

Pay attention to the following before using this unit:

- **Moving the unit.**
To prevent short-circuits or damaged wires in the connection cables, always unplug the power supply cord and disconnect the connection cables between all other audio components when moving the unit.
- **Cautions on using mobile phones.**
Using a mobile phone near this unit may result in noise. If so, move the mobile phone away from this unit when it is in use.
- **Before turning the power operation button on.**
Check once again that all connections are correct and that there are not problems with the connection cables. Always set the power operation button to the standby position before connecting and disconnecting connection cables.
- **Store these instructions in a safe place.**
After reading, store this instructions along with the warranty card in a safe place.
- **Whenever the power operation button is in the STANDBY state, the unit is still connected to AC line voltage.**
Please be sure to turn off the power operation button or unplug the cord when you leave home for, say, a vacation.
- **Note that the illustrations in these instructions may differ from the actual unit for explanation purposes.**

Getting Started

Cautions on installation

Note:

For heat dispersal, do not install this unit in a confined space such as a bookcase or similar enclosure.

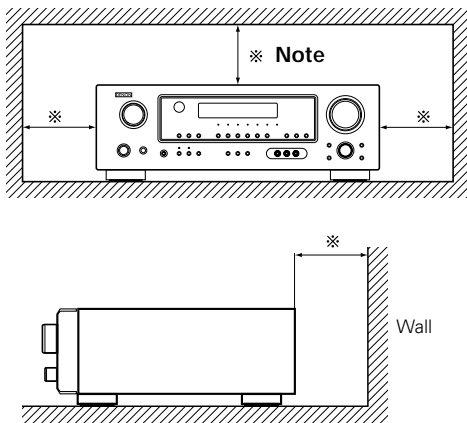

About the remote control unit

In addition to controlling the AVR-587, the attached remote control unit (RC-1048) can also be used to control the following products:

- ① DENON component products
- ② Component products other than DENON:
 - Set using the preset memory function (☞ page 44).

Inserting the batteries

- ① Remove the remote control unit's rear cover.
- ② Set two R6P/AA batteries in the battery compartment in the indicated direction.

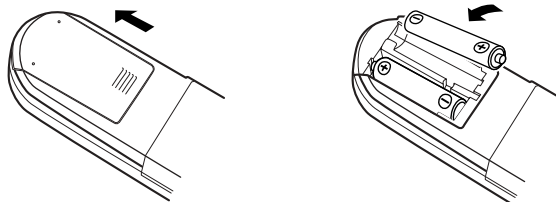

- ③ Put the rear cover back on.

Notes on batteries:

- Replace the batteries with new ones if the set does not operate even when the remote control unit is operated nearby the unit. (The attached batteries are only for verifying operation.)
- When inserting the batteries, be sure to do so in the proper direction, following the "⊕" and "⊖" marks in the battery compartment.
- To prevent damage or leakage of battery fluid:
 - Do not use a new battery together with an old one.
 - Do not use two different types of batteries.
 - Do not short-circuit, disassemble, heat or dispose of batteries in flames.
- Remove the batteries from the remote control unit when you do not plan to use it for an extended period of time.
- If the battery fluid should leak, carefully wipe the fluid off the inside of the battery compartment and insert new batteries.
- Remove the batteries from the remote if it will not be in use for long periods.

Getting Started

Operating range of the remote control unit

- Point the remote control unit at the remote sensor when operating it.
- The remote control unit can be used from a distance of approximately 23 feet/7 meters, at a horizontal angle of up to 30° with respect to the sensor.

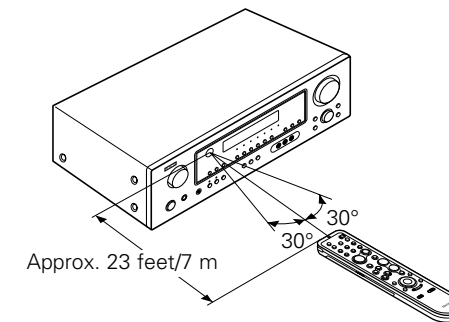
**NOTE:**

- It may be difficult to operate the remote control unit if the remote sensor is exposed to direct sunlight or strong artificial light.

Getting Started

Part names and functions

For details on the functions of these parts, refer to the pages given in parentheses ().

Front panel

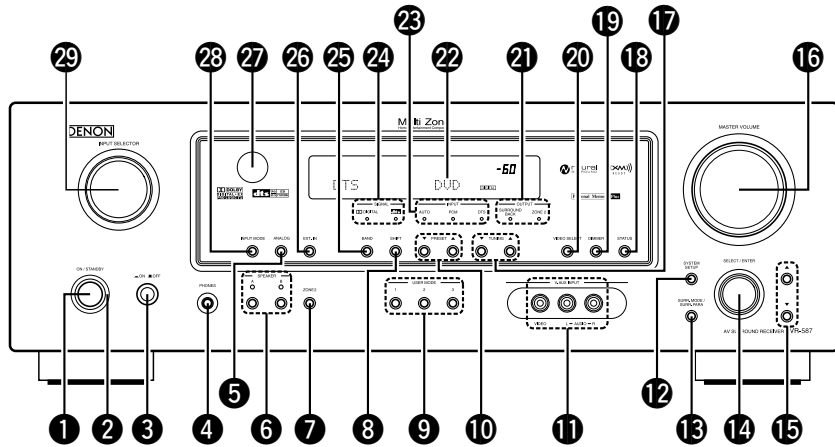

- 1 Power operation button (ON/STANDBY)(9)
- 2 Power indicator(9)
- 3 Power switch(9, 43)
- 4 Headphones jack (PHONES)(26)
- 5 ANALOG button(25)
- 6 SPEAKER buttons(9, 43)
- 7 ZONE2 button(42)
- 8 SHIFT button(37)
- 9 USER MODE buttons(39)
- 10 PRESET buttons(36)

- 11 V. AUX INPUT terminals
Remove the cap covering the terminals when you want to use them.

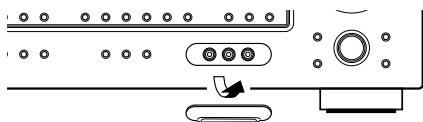

- 12 SYSTEM SETUP button(18)
- 13 SURR. MODE/SURR. PARA button(28, 35)
- 14 SELECT/ENTER knob(18, 35)



The **SELECT/ENTER** knob on the main unit operates in the same way as the **CURSOR** < and > buttons on the remote control unit.



- The control functions in the same way as the **CURSOR** < button when turned counterclockwise, as the **CURSOR** > button when turned clockwise.
- The control functions in the same way as the **ENTER** button when pressed the knob.

- 15 Cursor buttons (Δ, ▽)(18)
- 16 MASTER VOLUME control knob(9, 25)
- 17 TUNING buttons (▲, ▼)(37)
- 18 STATUS button(26)
- 19 DIMMER button(26)
- 20 VIDEO SELECT button(39)
- 21 OUTPUT indicators(28, 42)
- 22 Display
- 23 INPUT mode indicators(25)
- 24 SIGNAL indicators(28)
- 25 BAND button(37)
- 26 EXT. IN button(25)
- 27 Remote control sensor(3)
- 28 INPUT MODE button(25)
- 29 INPUT SELECTOR knob(25)

Display

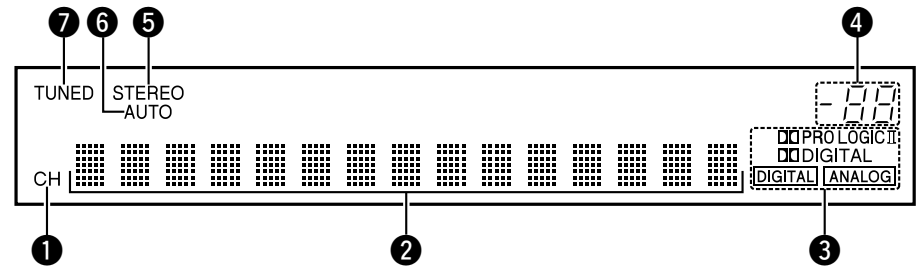

- 1 Signal channel indicator
Lights when the preset channel is displayed at 2.
- 2 Information display
- 3 Input signal indicators
- 4 Master volume indicator
This displays the volume level.
The Setup item number is displayed in System Setup.

- 5 STEREO indicator
This lights when an FM stereo broadcast has been received.
- 6 AUTO indicator
This lights when the broadcast station is selected in the AUTO tuning mode.
- 7 TUNED indicator
This lights when an FM/AM broadcast has been received.

Rear panel

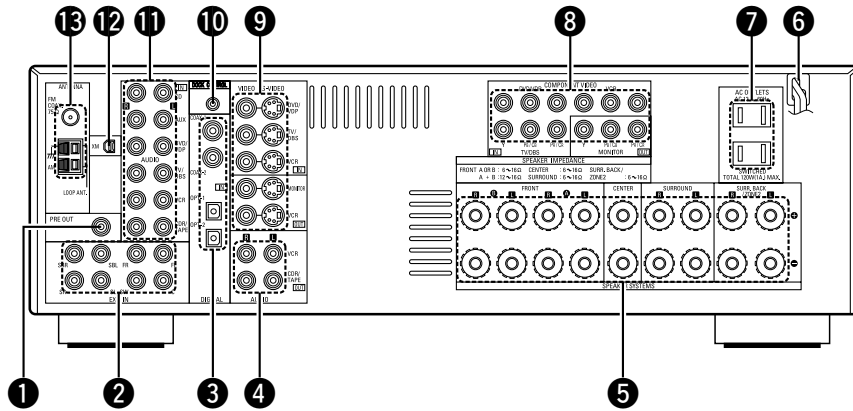

- 1 PRE OUT terminal.....(7)
- 2 EXT. IN terminals(11)
- 3 DIGITAL terminals
(Optical/Coaxial)(8, 12)
- 4 AUDIO OUT terminals.....(8, 12)
- 5 Speaker terminals(7, 14)
- 6 Power supply cord.....(15)
- 7 AC outlets.....(15)
- 8 COMPONENT VIDEO terminals.....(8)
- 9 VIDEO/S-VIDEO terminals.....(8)
- 10 DOCK CONTROL jack(14)
- 11 AUDIO IN terminals.....(8)
- 12 XM terminal(13)
- 13 ANTENNA terminals(13)

Remote control unit

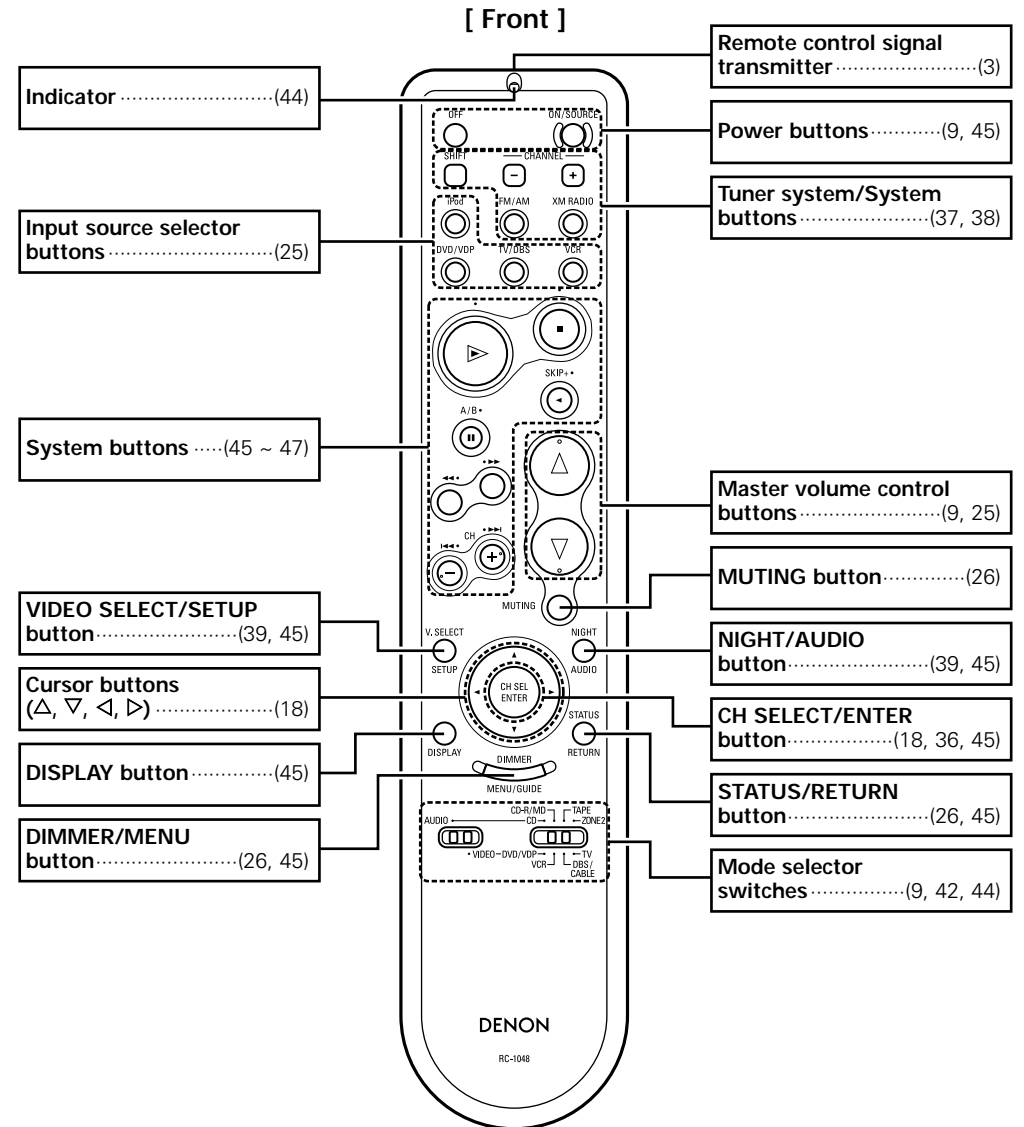

- 3 Remote control signal transmitter.....(3)
- 9, 45 Power buttons.....(9, 45)
- 37, 38 Tuner system/System buttons.....(37, 38)
- 44 Indicator.....(44)
- 25 Input source selector buttons.....(25)
- 45 ~ 47 System buttons.....(45 ~ 47)
- 9, 25 Master volume control buttons.....(9, 25)
- 26 MUTING button.....(26)
- 39, 45 NIGHT/AUDIO button.....(39, 45)
- 18, 36, 45 CH SELECT/ENTER button.....(18, 36, 45)
- 26, 45 STATUS/RETURN button.....(26, 45)
- 9, 42, 44 Mode selector switches.....(9, 42, 44)
- 39, 45 VIDEO SELECT/SETUP button.....(39, 45)
- 18 Cursor buttons (Δ, ∇, ◀, ▶).....(18)
- 45 DISPLAY button.....(45)
- 26, 45 DIMMER/MENU button.....(26, 45)

Getting Started

[Rear]

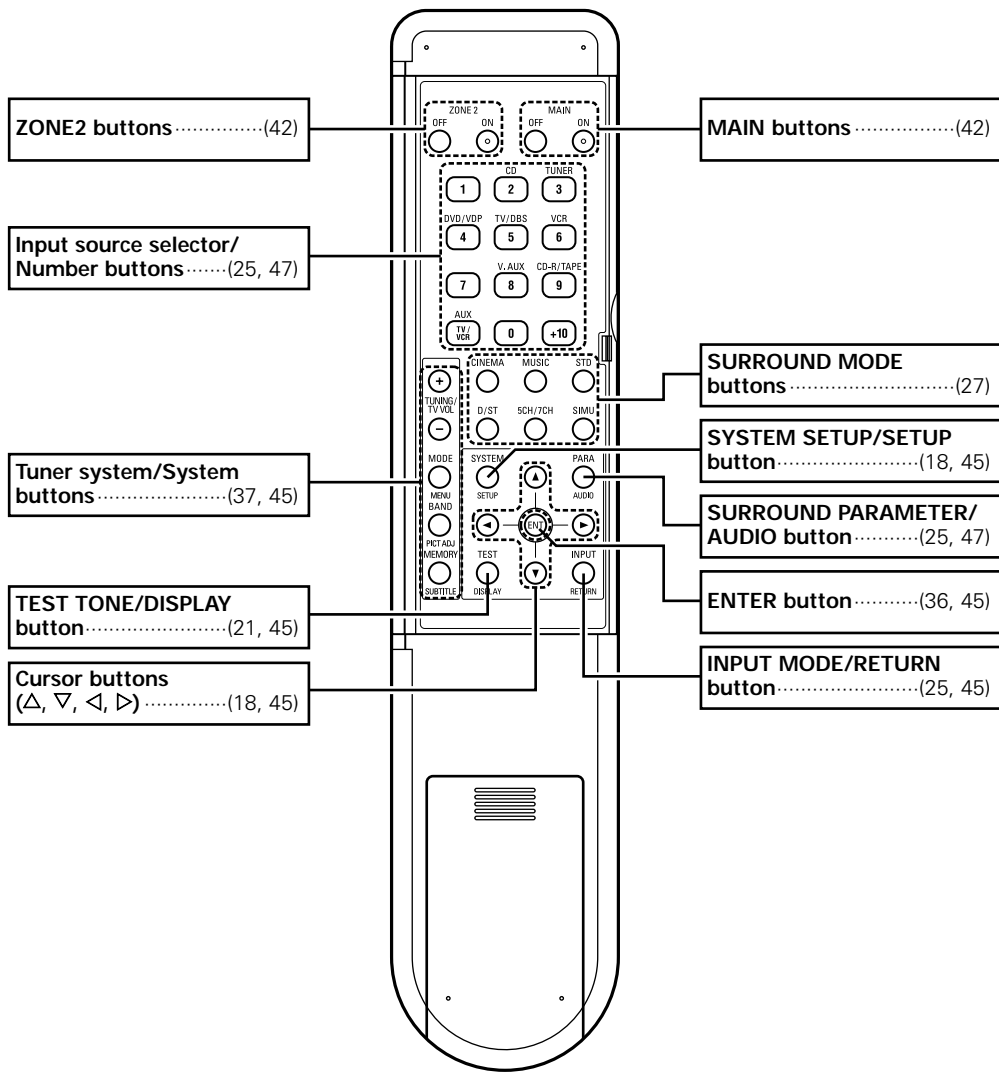

NOTE:

- If buttons on the front or rear are pressed strongly, the button on the opposite side will be activated too.

Easy Operation

Speaker layout [Basic layout]

Example of basic layout with eight speakers and a monitor.

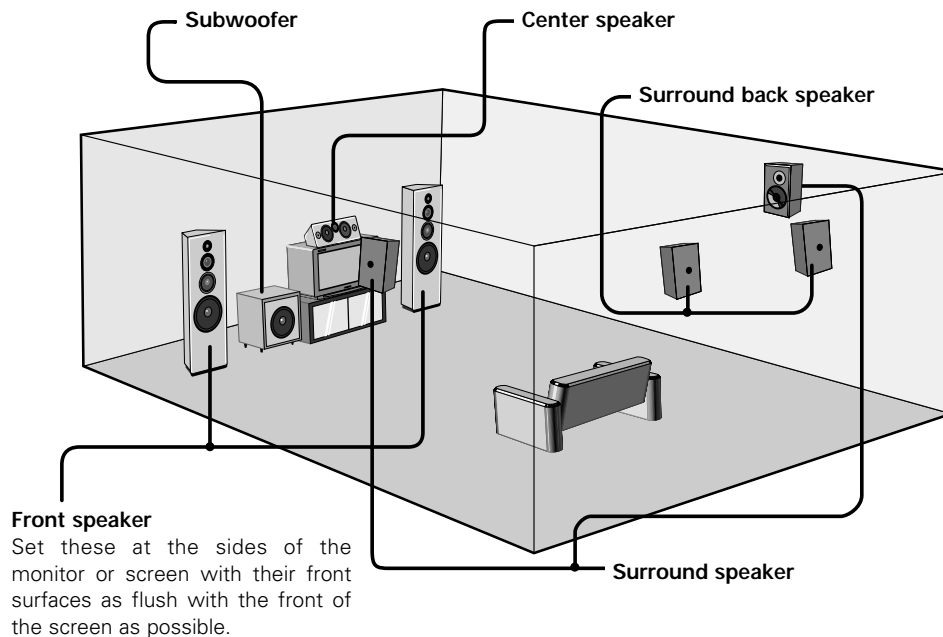

Easy Operation

Speaker connections

Connect the speaker terminals with the speakers making sure that like polarities are matched (⊕ with ⊕, ⊖ with ⊖).

NOTE:
When making connections, take care that none of the individual conductors of the speaker cable come in contact with adjacent terminals, with other speaker cable conductors, or with the rear panel and screws.
NEVER touch the speaker terminals when the power is on. Doing so could result in electric shocks.

Connecting the speaker cables

1. Loosen by turning counterclockwise.
 2. Insert the cable.
 3. Tighten by turning clockwise.
- Either tightly twist or terminate the core wires.

Connecting banana plugs

Turn clockwise to tighten, then insert the banana plug.

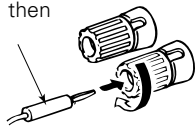

Speaker impedance

Speaker	Impedance
Front A, B	6 ~ 16 Ω/ohms
Front A+B	12 ~ 16 Ω/ohms
Center	6 ~ 16 Ω/ohms
Surround	
Surround back / ZONE2	

Note on speaker impedance

When using speakers with an impedance below the designated value (for example 4 Ω/ohms), playing for long periods of time with the volume high could cause the temperature to rise, activating the protection circuit. When the protection circuit is activated, the output to the speakers is cut off and the power indicator blinks. If this happens, unplug the power cord, wait for the set to cool off and improve ventilation around the unit. Also check the wiring of the input cables and the speaker cables. After doing this, plug the power cord back in and turn the unit's power back on. If the protection circuit is activated again even though there are no problems with the wiring or the ventilation around the unit, switch off the power and contact a DENON service center.

Easy Operation

Connections

- With the AVR-587, up to ten speakers can be connected for surround playback.
- When making connections, also refer to the operating instructions of the other components.

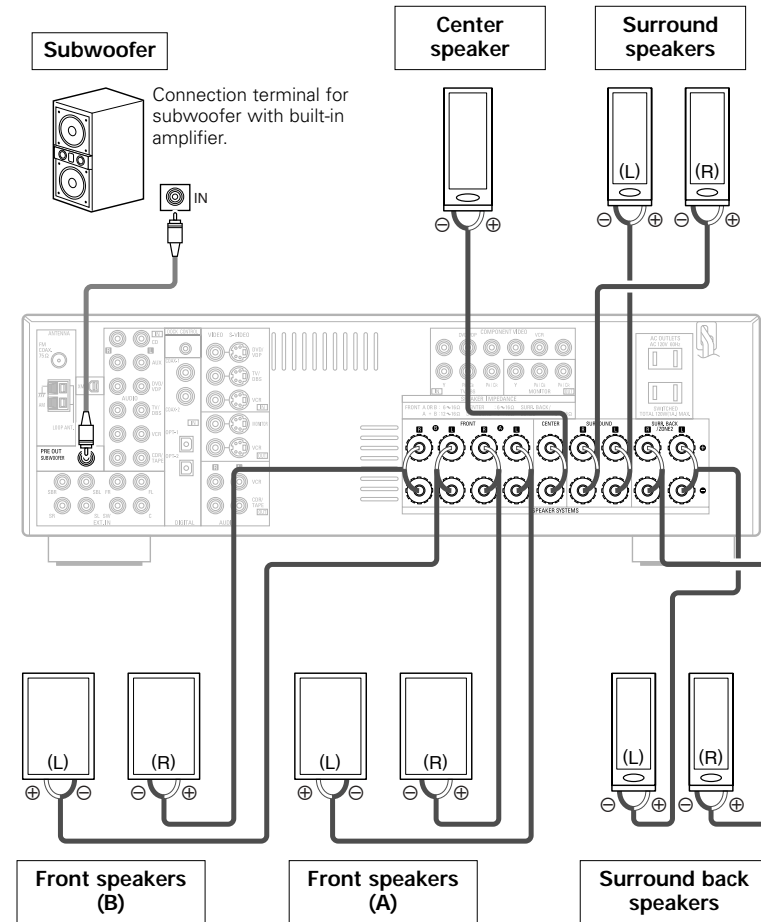

When using only one surround back speaker, connect it to the left channel.

Easy Operation

Connecting a DVD player and monitor

- To connect the digital audio output from the DVD player, you can choose from either the coaxial or optical connections. If you choose to use the coaxial connection, it needs to be assigned. For more information about Digital Input Assignment (page 21).
- **Precaution when using S-Video terminals**
AVR-587's S-Video terminals (input and output) and video terminals (input and output) have independent circuit structures, so that video signals input from the S-Video terminals are only output from the S-Video terminal outputs and video signals input from the terminals are only output from the terminal outputs. When connecting AVR-587 with equipment that is equipped with S-Video terminals, keep the above point in mind and make connections according to the equipment's instruction manuals.

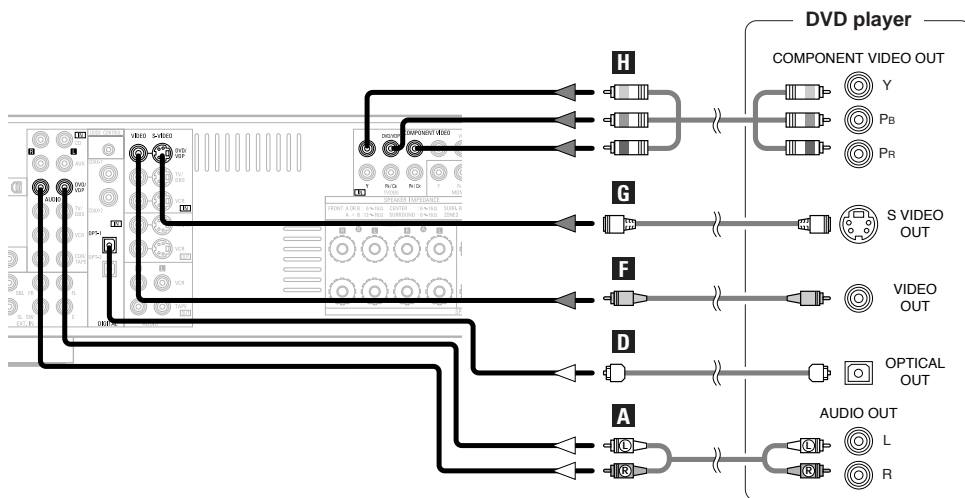

※ Audio signal flow is shown with white arrows, video signal flow is shown with gray arrows.



- Connect a non-DVD video disc player (such as a laser disc, VCD/SVCD, or future high definition disc player) to the DVD/VDP terminals in the same way.

Easy Operation

- For best picture quality (especially with progressive DVD and other high definition sources), choose the component video connection to your monitor. S-Video and composite video outputs are also provided if your monitor does not have component video inputs.
- The signals input to the color difference (component) video terminals are not output from the VIDEO output terminal (yellow) or the S-Video output terminal.

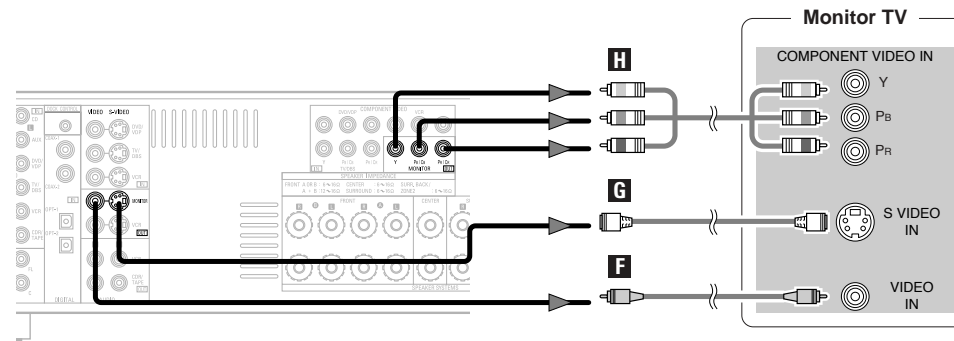

- The component video input and/or output terminals may be labelled differently on some monitors or video components. Check the owner's manuals for other components for further information.

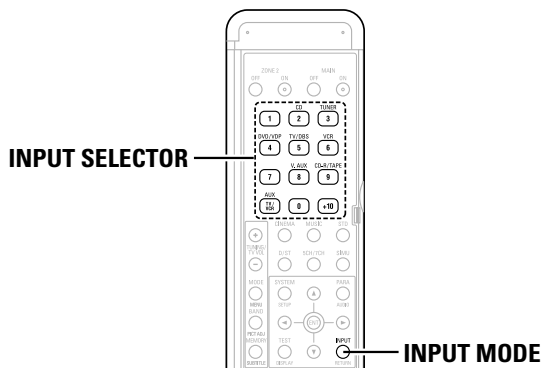
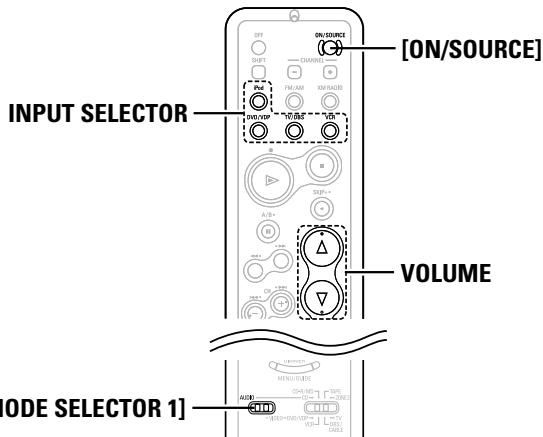
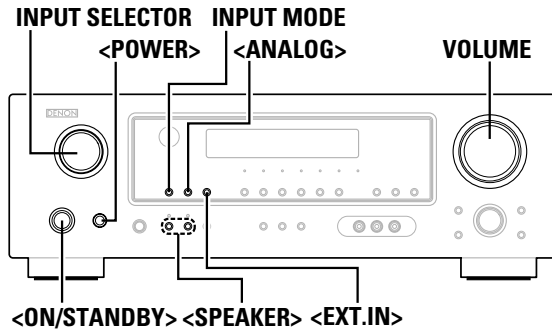

About the button names in this explanation
 < > : Buttons on the main unit
 [] : Buttons on the remote control unit
Button name only :
 Buttons on the main unit and remote control unit

Before operating

- 1 Turn on your subwoofer.**
 - ※ Set the volume to halfway and set the crossover frequency to the maximum or Low pass filter off if your subwoofer can adjust the output volume and the crossover frequency.
 - ※ Some subwoofers have a standby mode. Be sure to turn this function off before performing the Auto Setup procedure.

- 2 Turn on your monitor.**

- 3 Press <POWER>.**
 - **ON:**
The power indicator lights red.
 - **OFF:**
The power turns off and the indicator is off.

- 4 Press <ON/STANDBY> or [ON/SOURCE].**
 - The power indicator blinks green and the power turns on.

- 5 Press <SPEAKER> to select the front speaker (Front A, Front B or Front A+B).**

- 6 Set [MODE SELECTOR 1] to “AUDIO”.**

Playing the input source

- 1 Use INPUT SELECTOR to select the input source you want to play.**

- 2 Press INPUT MODE.**

```

            graph LR
            AUTO --> PCM
            PCM --> DTS
            DTS --> ANALOG
            ANALOG --> EXT_IN[EXT. IN]
            EXT_IN --> ANALOG
            ANALOG --> EXT_IN
            
```

 - ※ Press <ANALOG> to select “ANALOG”, <EXT. IN> to select “EXT. IN”.

- 3 Start playback on the selected component.**
 - ※ For operating instructions, refer to the component’s manual.

- 4 Use VOLUME to adjust the volume.**
 - The volume level is displayed on the master volume level display.

Connecting Other Sources

Cable indications

The hookup diagrams on the subsequent pages assume the use of the following optional connection cables (not supplied).

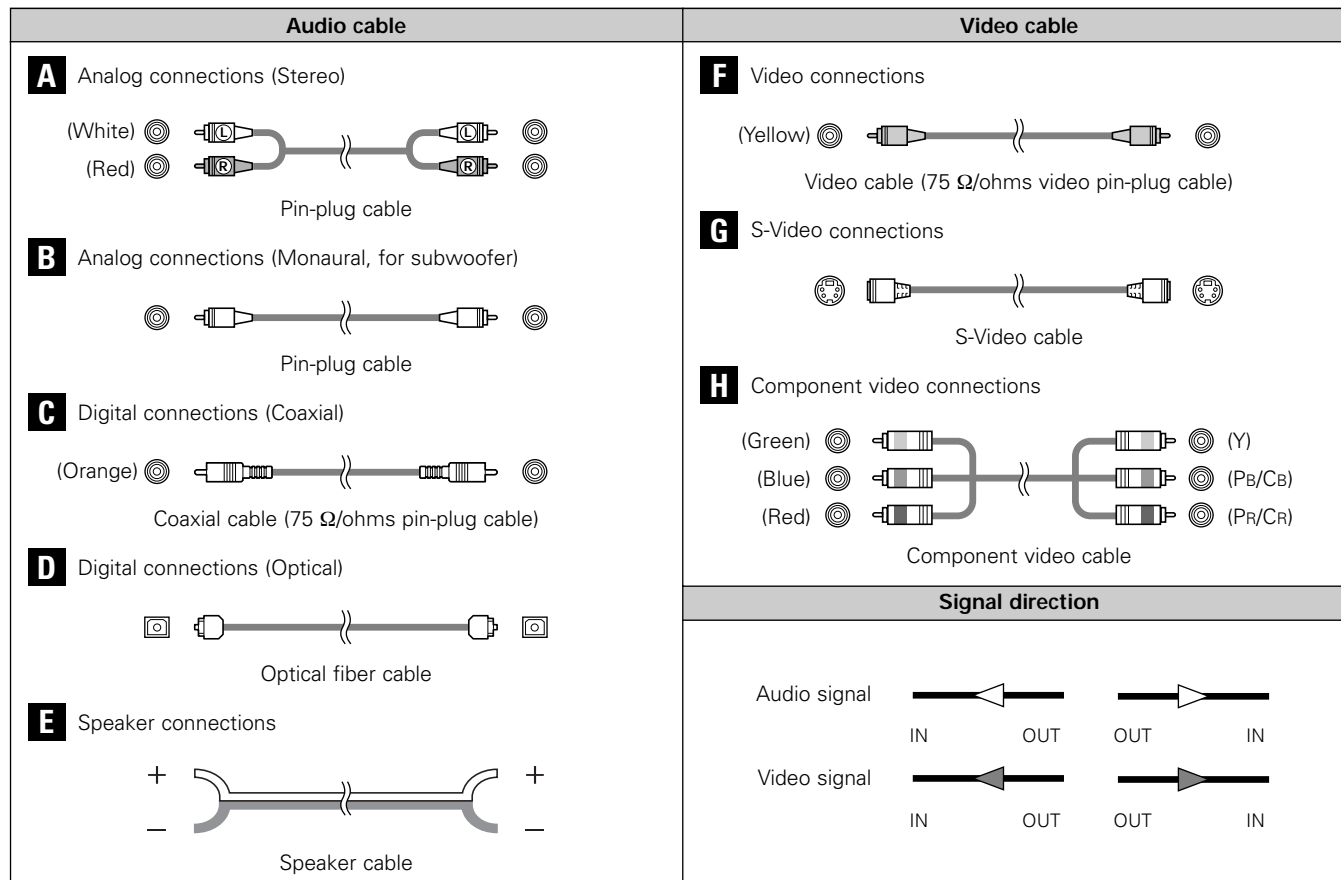

NOTE:

- Do not plug in the power supply cord until all connections have been completed.
- When making connections, also refer to the operating instructions of the other components.
- Be sure to connect the left and right channels properly (left with left, right with right).
- Do not bundle power cords together with speaker cables. Doing so could result in humming or noise.

Connecting Other Sources

Connecting a TV/DBS tuner

- To connect the digital audio output from the TV or DBS tuner, you can choose from either the coaxial or optical connections. If you choose to use the coaxial connection, it needs to be assigned. For more information about Digital Input Assignment (page 21).
- Precaution when using S-Video terminals**
AVR-587's S-Video terminals (input and output) and video terminals (input and output) have independent circuit structures, so that video signals input from the S-Video terminals are only output from the S-Video terminal outputs and video signals input from the terminals are only output from the terminal outputs. When connecting AVR-587 with equipment that is equipped with S-Video terminals, keep the above point in mind and make connections according to the equipment's instruction manuals.
- The signals input to the component (color difference) video terminals are not output from the VIDEO output terminal (yellow) or the S-Video output terminal.

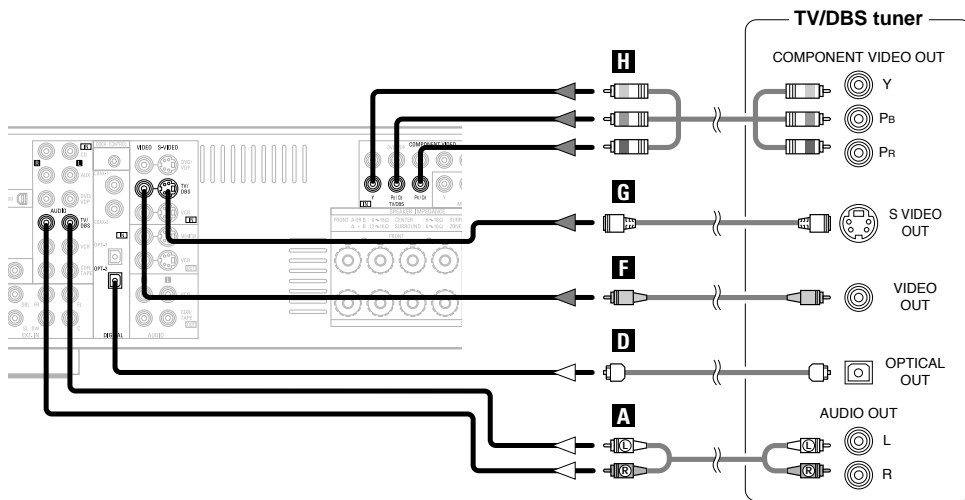

Connecting a video camera or video game

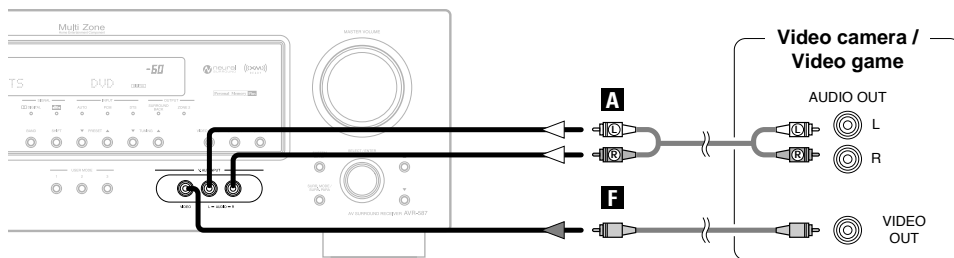

Connecting Other Sources

Connecting the external inputs (EXT. IN) terminals

- These terminals are for inputting multi-channel audio signals from an outboard decoder, or a component with a different type of multi-channel decoder, such as a DVD-Audio player, or a multi-channel Super Audio CD player, or other future multi-channel sound format decoder.
- The video signal connection is the same as that for a DVD player (page 8).
- For instructions on playback using the external input (EXT. IN) terminals (page 25).

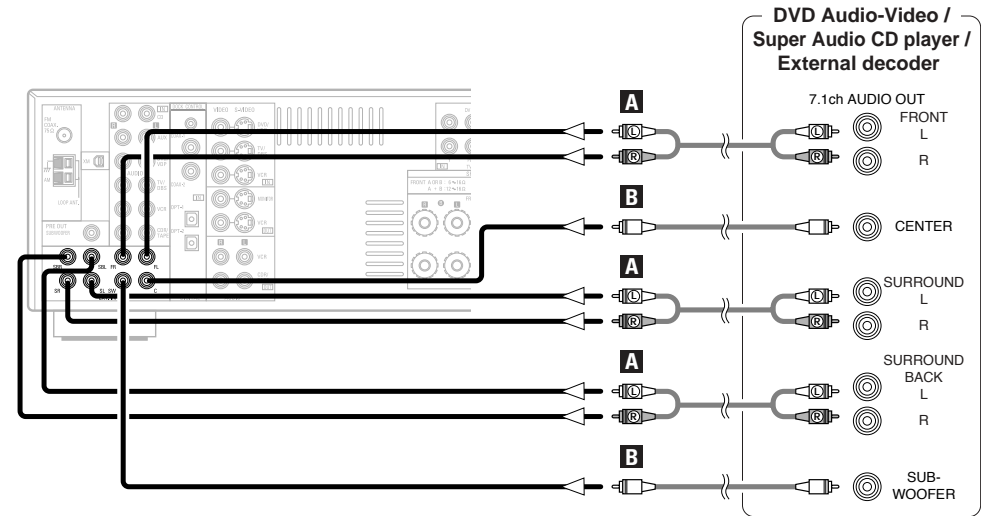

- With discs on which special copyright protection measures have been taken, however, the digital signals may not be output from the DVD player. In this case, connect the DVD player's analog multi-channel output to the AVR-587's EXT. IN terminals for playback. Also refer to your DVD player's operating instructions.

Connecting Other Sources

Connecting a CD player

To connect the digital audio output from the CD player, you can choose from either the coaxial or optical connections. If you choose to use the optical connection, it needs to be assigned. For more information about Digital Input Assignment (see page 21).

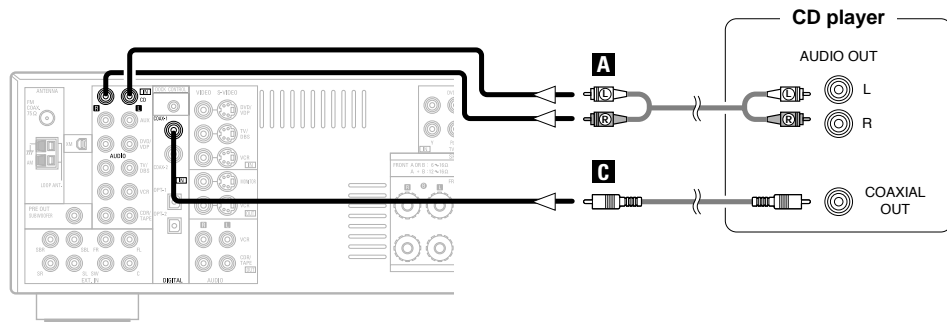

Connecting a tape deck, CD recorder or MD recorder

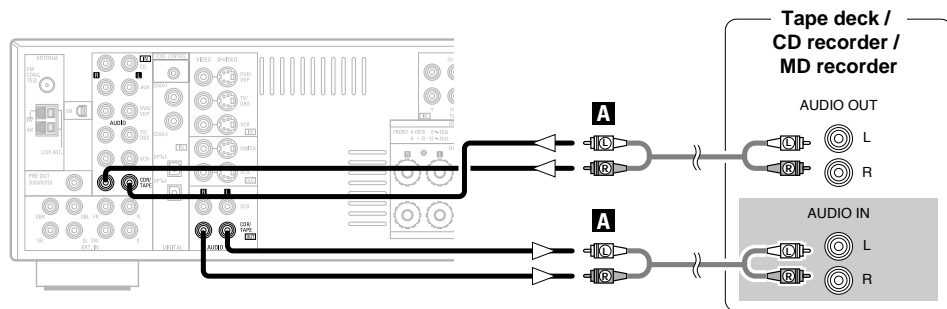

Connecting Other Sources

Connecting a VCR

- If you wish to perform analog dubbing from a digital source, such as a DVD recorder to an analog recorder such as a cassette deck, you will need to connect the analog inputs and outputs as shown below, in addition to the digital audio connections.
- **Precaution when using S-Video terminals**
AVR-587's S-Video terminals (input and output) and video terminals (input and output) have independent circuit structures, so that video signals input from the S-Video terminals are only output from the S-Video terminal outputs and video signals input from the terminals are only output from the terminal outputs. When connecting AVR-587 with equipment that is equipped with S-Video terminals, keep the above point in mind and make connections according to the equipment's instruction manuals.
- The signals input to the component (color difference) video terminals are not output from the VIDEO output terminal (yellow) or the S-Video output terminal.

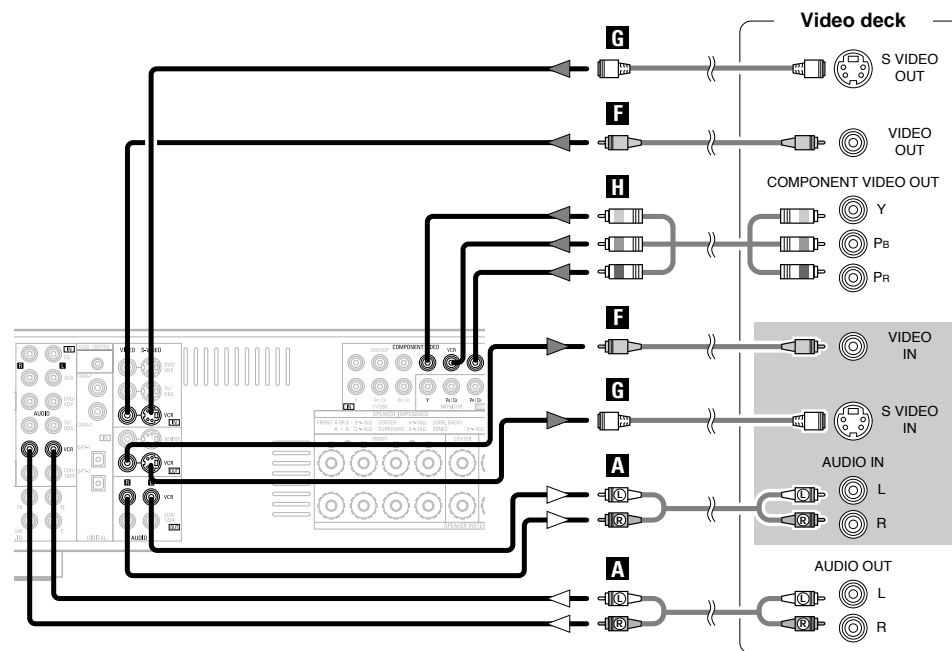

- When recording to a VCR, it is necessary that the type of cable used with the playback source equipment be the same type that is connected to the AVR-587 VCR OUT terminal.
Example: TV IN → S-Video cable : VCR OUT → S-Video cable
TV IN → Video cable : VCR OUT → Video cable

Connecting Other Sources

Connecting the antenna terminals

An F-type FM antenna cable plug can be connected directly.

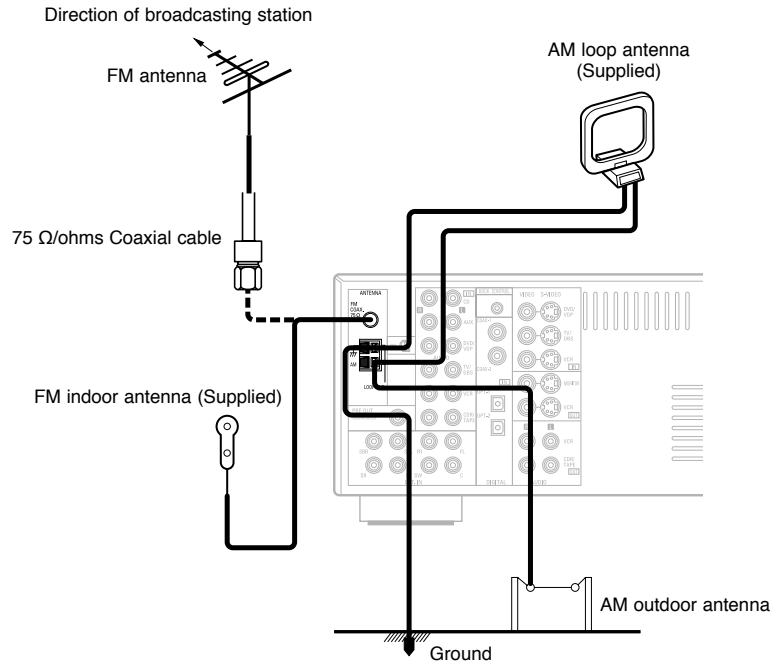

AM loop antenna assembly

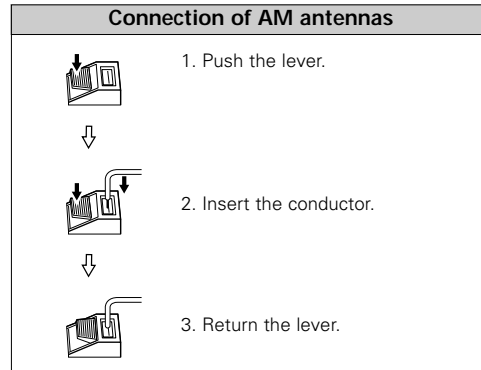
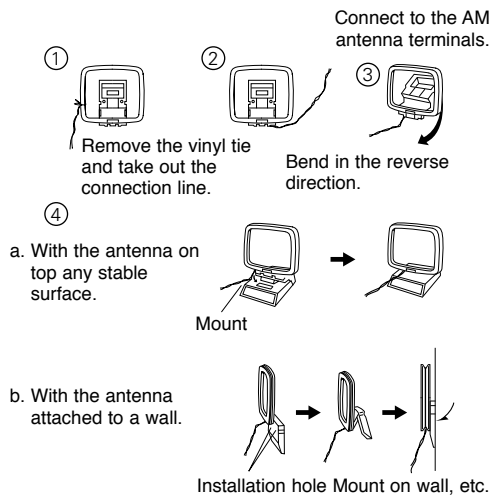

Connecting Other Sources

NOTE:

- Do not connect two FM antennas simultaneously.
- Even if an external AM antenna is used, do not disconnect the AM loop antenna.
- Make sure the AM loop antenna lead terminals do not touch metal parts of the panel.

Note to CATV system installer:

This reminder is provided to call the CATV system installer's attention to Article 820-40 of the NEC which provides guidelines for proper grounding and, in particular, specifies that the cable ground shall be connected to the grounding system of the building, as close to the point of cable entry as practical.

Connecting the XM terminal

- AVR-587 is the XM Ready® receiver. You can receive XM® Satellite Radio by connecting to the XM Passport System (sold separately) and subscribing to the XM service.
 - Plug the XM Passport System into XM terminal on the rear panel.
 - Position the XM Passport System near a south-facing window to receive the best signal. For details, see "XM Satellite Radio" (page 38).
- When making connections, also refer to the operating instructions of the XM Passport System.

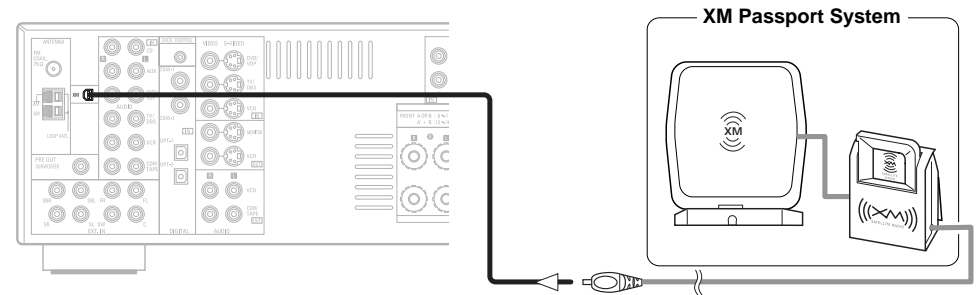

NOTE:

- Keep the power supply cord unplugged until the XM Passport System connection has been completed.

- The XM name and related logo are registered trademarks of XM Satellite Radio Inc. All rights reserved.
- XM Ready is a registered trademark of XM Satellite Radio Inc. All rights reserved.

Connecting Other Sources

Connecting the iPod®

When using an iPod, you must connect the Control Dock for iPod (ASD-1R, sold separately) and the DOCK CONTROL jack on the AVR-587 with a mini-jack and assign the iPod to any AUDIO and/or S-VIDEO terminal(s).

The diagram below shows an example of connections for when the iPod is assigned to the DVD/VDP terminal.

- ※ For instructions on assigning the iPod to a specific terminal, see "Setting the iPod Assignment" (page 22).
- ※ For instructions on playing the iPod, see "Playing the iPod" (page 40, 41).

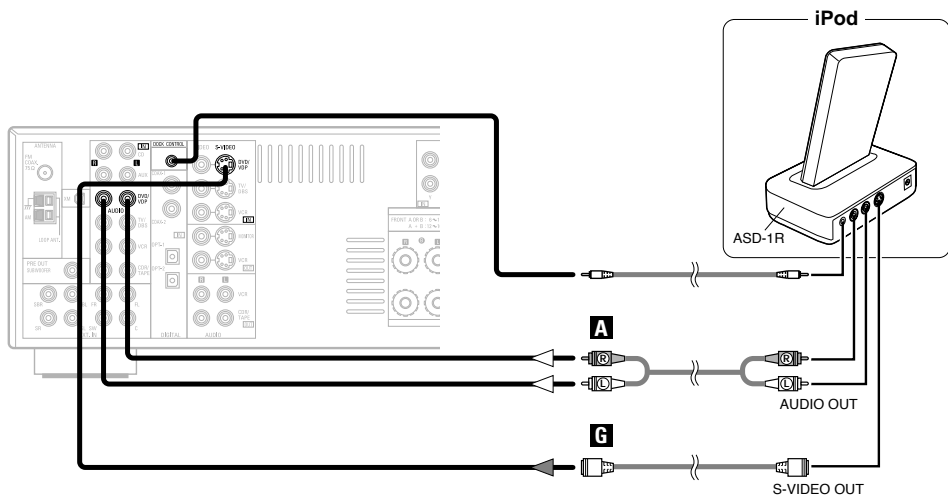

• The optional standard Control Dock for iPod is DENON ASD-1R sold separately.

Connecting Other Sources

Connecting the MULTI ZONE terminals

※ For instructions on operations using the MULTI ZONE functions (page 42).

ZONE2 speaker out connections

- When the surround back's power amplifier is assigned to the ZONE2 output channel at Power Amplifier Assignment mode, the surround back speaker terminals can be used as the ZONE2 speaker out terminals (page 42).
- The connections diagram below is an example for when the surround back speaker is assigned to the ZONE2 stereo 2 channel. In this case, surround back speaker out can not be used for MAIN ZONE.

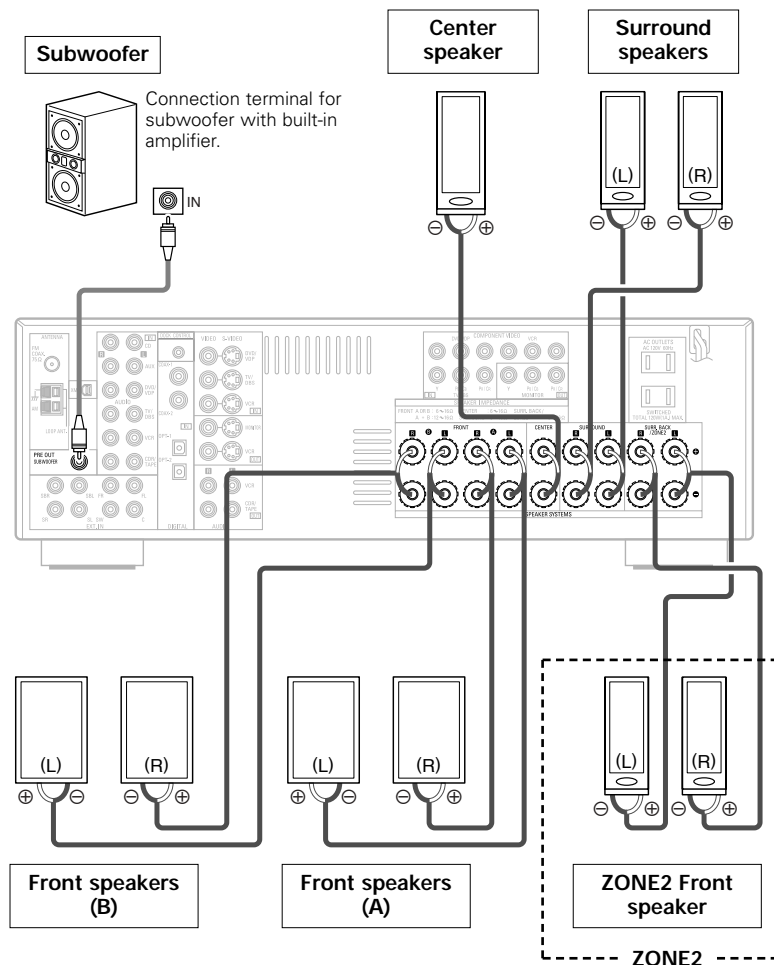

Connecting the power supply cord

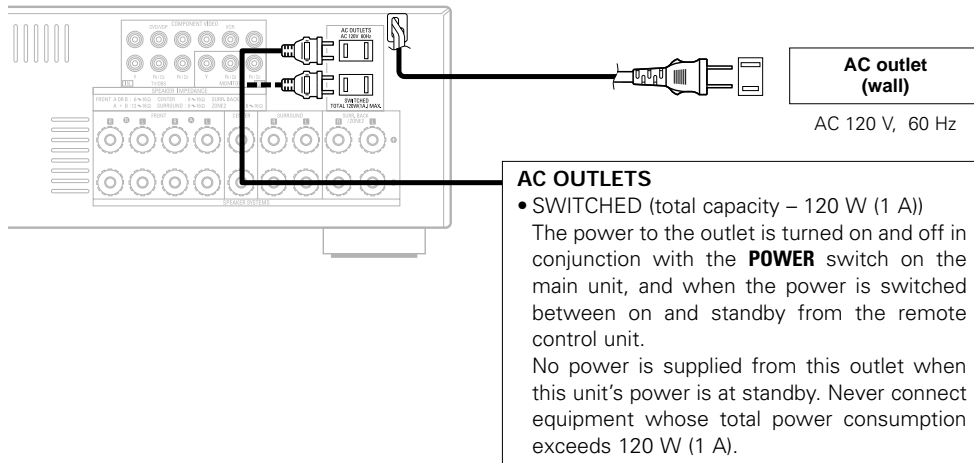
**NOTE:**

- Insert the plugs securely. Incomplete connections will result in the generation of noise.
- Only use the AC OUTLETS for audio equipment. Never use it for hair driers, monitors or other electrical appliances.

System Setup

System setup items and default values

1. Speaker Setup

Speaker Setup 1

Item No.	Items	Default settings					Page				
		Front Sp.	Center Sp.	Subwoofer	Surround Sp.	Surround Back Sp.					
1 ~ 6	Speaker Configuration mode	Automatically set the output component and properties for the various channels according to the combination of speakers to be actually used for surround playback.	Front Sp.	Center Sp.	Subwoofer	Surround Sp.	Surround Back Sp.	19			
			Large	Small	Yes	Small	Small / 2sp				
7	Subwoofer Mode Setup	Select the method of playback of the subwoofer for playing the low bass signals.	LFE (Normal)					19			
8 ~ 15	Distance mode	This parameter is for optimizing the timing with which the audio signals are produced from the speakers and subwoofer according to the listening position.	Front L & R	Center	Subwoofer	Surround L & R	Surround Back	20			
			12 ft	12 ft	12 ft	10 ft	10 ft				
16	Crossover Frequency mode	Set the frequency (Hz) below which the bass sound of the various speakers is to be output from the subwoofer.	80 Hz					20			
17	Test Tone mode	Set the volume of the various speakers so that the sound output from the speakers and the subwoofer seems to have the same volume level.	Front L	Front R	Center	Surround L	Surround R	Surround Back L	Surround Back R	Subwoofer	21
			0 dB	0 dB	0 dB	0 dB	0 dB	0 dB	0 dB	0 dB	

2. Input Setup

Input Setup 2

Item No.	Items	Default settings				Page		
		Digital Inputs	Input source	COAX 1	COAX 2		OPT 1	OPT 2
1 ~ 4	Digital In Assignment mode	This assigns the different input sources for the digital input terminals.	Digital Inputs	COAX 1	COAX 2	OPT 1	OPT 2	21
			Input source	CD	AUX	DVD	TV	
5	iPod Assignment mode	It is possible to assign the Control Dock for iPod's (ASD-1R, sold separately) audio and/or video signals to any input terminals on the AVR-587 and play them.	iPod Function = OFF				22	
6	EXT. IN Subwoofer Level mode	Sets the playback level of the analog signal that was input to the EXT. IN subwoofer terminal.	SW Level = +15 dB				22	
7	Auto Preset Memory mode	Up to 56 FM stations can be preset automatically.	A1 ~ A8	87.5/89.1/98.1/107.9/90.1/90.1/90.1 MHz				22
			B1 ~ B8	520/600/1000/1400/1500/1710 kHz, 90.1/90.1 MHz				
			C1 ~ C8	90.1 MHz				
			D1 ~ D8	90.1 MHz				
			E1 ~ E8	90.1 MHz				
			F1 ~ F8	90.1 MHz				
			G1 ~ G8	90.1 MHz				

System Setup

3. Option Setup

System Setup

Option Setup 3

Item No.	Items		Default settings	Page
1	Power Amp Assignment mode	To suit your preference, a surround back channel's power amplifier can be assigned to the ZONE2.	S. Back	23
2 ~ 4	Volume Control mode	This sets the volume level of output.	Vol.Limit = OFF P. On Lev. = LAST Mute Lev. = FULL	23
5	Auto Surround mode	Set whether or not to store the surround mode last played for the input signal.	Auto Surround Mode = ON	24

System Setup

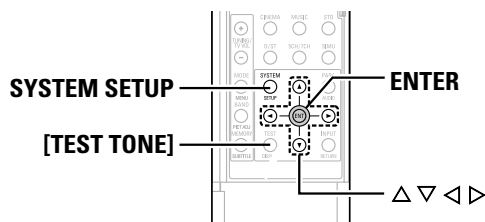
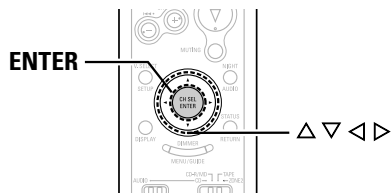
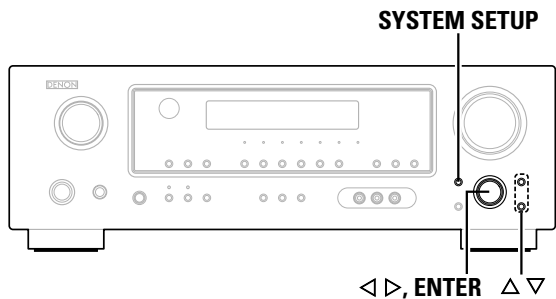

About the button names in this explanation
 < > : Buttons on the main unit
 [] : Buttons on the remote control unit
Button name only :
 Buttons on the main unit and remote control unit

Use System Setup to customize a variety of settings to suit your listening environment.
 For the contents of a system menu and the initial setting of this unit (see page 16, 17).

Navigating through the System Setup items

- 1** Press **SYSTEM SETUP**, then press **ENTER**.
 - 2** Press < > to select the item you want to set, then press **ENTER**.
 - 3** To change the setting:
 Press Δ ∇ to select the item you want to change, then press < > to change the setting.
 - 4** Press **ENTER** or ∇ to confirm the new settings.
 - 5** Press **SYSTEM SETUP** to move the next category.
- ※ To cancel the system setup mode, press **SYSTEM SETUP** again.

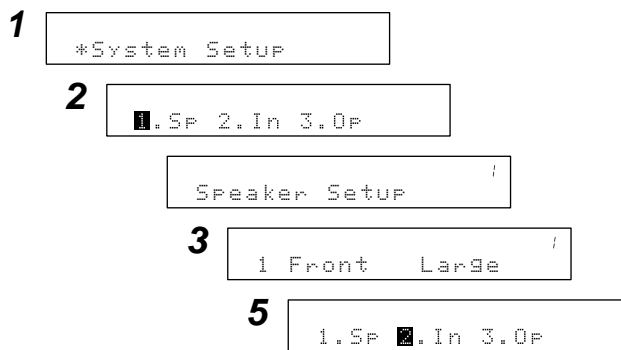

System Setup

About the front display

The AVR-587 is equipped with an alpha numeric front panel display that can also be used to check and adjust settings. Some representative front display examples are shown below.

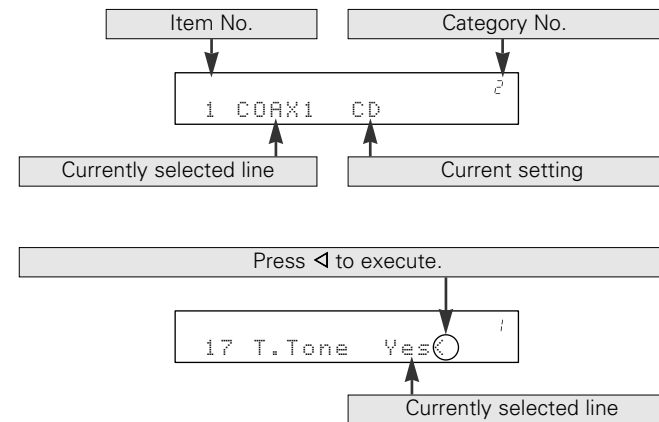

System Setup

Speaker Setup

- Perform this setting if you wish to make the settings for your speaker systems manually.

Setting the Speaker Configuration

Automatically set the output component and properties for the various channels according to the combination of speakers to be actually used for surround playback.

1 Press ◀▶ to select “1. Sp”, then press ENTER.

2 Press △▽ to select the speaker, then press ◀▶ to set.

Large:

Select this when using large speakers with ample low frequency reproduction capabilities.

Small:

Select this when using small speakers without ample low frequency reproduction capabilities.

None:

Select this when no speaker is connected.

2sp / 1sp:

Select the number of surround back speakers.

Yes / No:

Select “Yes” when a subwoofer is connected, “No” when no subwoofer is connected.

※ A subwoofer with sufficient low frequency playback capability can better handle deep bass than most main and surround speakers, and the system's overall performance will be greatly enhanced when “Small” is set for the main (front) and surround speakers.

※ When “Front” is set to “Small”, “Subwoofer” is automatically set to “Yes”, and when “Subwoofer” is set to “No”, “Front” is automatically set to “Large”.

3 Press ENTER or ▽ to enter the setting and switch to the Subwoofer Mode Setup setting.

1 1. Sp 2. In 3. Op

Speaker Setup

2 1 Front Large

⋮
6 Subwoofer Yes

3 7 SW Mode Norm



- Select “Large” or “Small” not according to the actual size of the speaker but according to the speaker's capacity for playing low frequency (bass sound below the frequency set for the Crossover Frequency) signals. If you do not know, try comparing the sound at both settings (setting the volume to a level low enough so as not to damage the speakers) to determine the proper setting.

System Setup

Setting the Subwoofer Mode Setup

Select the method of playback of the subwoofer for playing the low bass signals.

1 Press ◀▶ to set.

LFE (Normal):

For any channel(s) that are set to “Large”, low frequencies in that channel's corresponding source are directed to that loudspeaker only. The low frequencies played from the subwoofer are only the LFE signals and the low frequencies of channels set to “Small”.

LFE+Main:

Low frequencies from speaker channels that have been set to “Large” are reproduced from those speakers as well as from the subwoofer(s).

2 Press ENTER or ▽ to enter the setting and switch to the Distance setting.

1 7 SW Mode +Main

2 8 FL 12ft



- The subwoofer mode setting is only valid when and “Yes” is set for the subwoofer in the “Setting the Speaker Configuration”.
- Select the “LFE+Main” mode if you want low frequency signals to always be played from the subwoofer channel.
- Select the mode achieving a voluminous bass sound when playing music or movie sources.

System Setup

Setting the Distance

This parameter is for optimizing the timing with which the audio signals are produced from the speakers and subwoofer according to the listening position.

Preparations:

Measure the distances between the listening position and the speakers (L1 to L8 on the diagram at the below).

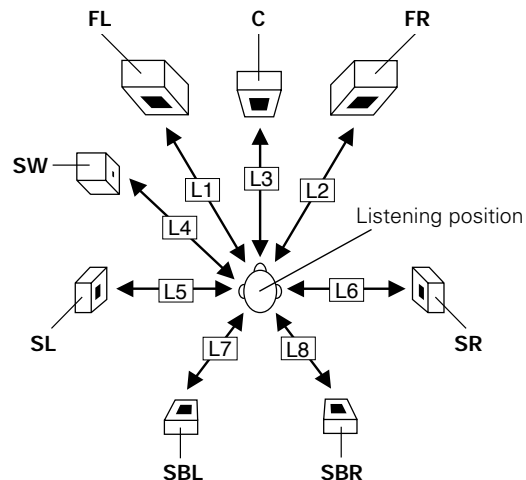

1 Press ◀ ▶ to set.

2 Press ENTER or ▼ to enter the setting and switch to the Crossover Frequency setting.

1 8 FL 15ft

⋮

15 SW 12ft

2 16Cr.Over 80Hz



- The distance changes in units of 1 foot (0.1 meters) each time the button is pressed. Select the value closest to the measured distance.
- **Please note that the difference of distance for every speaker should be 20 ft (6.0 m) or less.**

Setting the Crossover Frequency

Set the frequency (Hz) below which the bass sound of the various speakers is to be output from the subwoofer.

For speakers that are set to "Small", frequencies under the crossover frequency are cut before the signal is output, and the low frequency component that was cut is output from the subwoofer or the speakers that are set to "Large".

1 Press ◀ ▶ to set.

40, 60, 80, 90, 100, 110, 120, 150, 200, 250 Hz:

Set as desired according to your speakers' bass playback ability.

2 Press ENTER or ▼ to enter the setting and switch to the Test Tone setting.

1 16Cr.Over 100Hz

2 17 T.Tone Yes<



- The crossover frequency mode is valid only when subwoofer is set to "ON", and when one or more speakers are set to "Small", as described in section "Setting the Speaker Configuration" (page 19).
- Set to "80 Hz" when using regular speakers. When using small speakers, we recommend setting to a higher frequency.

System Setup

Setting the Test Tone

Set the volume of the various speakers so that the sound output from the speakers and the subwoofer seems to have the same volume level.

1 Press \triangleleft to select “Yes”.

2 Press $\triangleleft \triangleright$ to set, then press ∇ .

Auto:

Adjust the level while listening to the test tones produced automatically from each speaker.

Test tones are automatically emitted from each speaker.

Manual:

Adjust with the speaker from which the test tone is output switched manually.

3 When “Auto” mode is selected:

Press $\triangleleft \triangleright$ to adjust the volume.

-1 • Test tones are output automatically, in the order shown below.

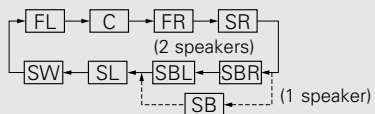

※ The volume can be adjusted within the range -12 dB to +12 dB.

3 When “Manual” mode is selected:

Press $\triangle \nabla$ to select the speaker, then press $\triangleleft \triangleright$ to adjust the volume.

4 Press **ENTER** to finish the Test Tone setting.

5 Press **ENTER** to enter the setting and switch to the Option Setup.

1 17 T.TONE Yes<

2 T.Tone Auto >

3 TEST TONE ON

AUTO-FL

5 1.SP [] In 3.0P



- To adjust the channel level separately for the different play modes after setting the channel level, perform the operation on page 36.

Adjusting the test tone using the remote control unit

Adjustment of the test tones using the remote control unit is only possible in the “Auto” mode and only valid in the STANDARD (Dolby/DTS Surround) mode. The adjusted levels are automatically stored for the different surround modes.

1 Press **[TEST TONE]**.

- Test tones are output from the different speakers.

2 Press $\triangleleft \triangleright$ to adjust the volume.

3 Press **[TEST TONE]**.

System Setup

Input Setup

Setting the Digital In Assignment

This assigns the different input sources for the digital input terminals.

1 Press $\triangleleft \triangleright$ to select “2. In”, then press **ENTER**.

2 Press $\triangle \nabla$ to select the input terminals, then press $\triangleleft \triangleright$ to set.

CD, AUX, DVD, TV, VCR, V.AUX, CD-R:

Assign the different source according to the devices connected to the AVR-587's input terminals.

3 Press **ENTER** or ∇ to enter the setting and switch to the iPod Assignment setting.

1 1.SP [] In 3.0P

Input Setup 2

2 1 COAX1 CD 2

2 COAX2 AUX 2

3 5 iPod OFF 2



- Digital input terminal assignment not possible for “TUNER”.
- It is not possible to make the Digital In Assignment settings for the function assigned at iPod Assignment mode.

System Setup

System Setup

Setting the iPod Assignment

It is possible to assign the Control Dock for iPod's (ASD-1R, sold separately) audio and video signals to any input terminals on the AVR-587 and play them.

1 Press ◀▶ to set.

CD, AUX, CD-R:

When using a Control Dock for iPod, it is possible to connect with the audio input terminal of the assigned function.

DVD, TV, VCR, V.AUX:

When using a Control Dock for iPod, it is possible to connect with the audio and video input terminals of the assigned function.

OFF:

This is the factory default setting.

2 Press ENTER or ▽ to enter the setting and switch to the EXT. IN Subwoofer Level setting.

1 5 iPod CD 2

2 6 EXT.In SW +15 2

Setting the EXT. IN Subwoofer Level

Sets the playback level of the analog signal that was input to the EXT. IN subwoofer terminal.

1 Press ◀▶ to set.

+15 dB, +10 dB, +5 dB, 0 dB:

Sets the playback level of the analog signal that was input to the EXT. IN subwoofer terminal.

2 Press ENTER or ▽ to enter the setting and switch to the Auto Preset Memory setting.

1 6 EXT.In SW +10 2

2 7 Preset <Start 2

Setting the Auto Preset Memory

Up to 56 FM stations can be preset automatically (☞ page 36).

1 Press ◀ to start.

- "CH" blinks on the display and searching begins.
- "Completed" appears once searching is completed.

2 Press ENTER to enter the setting and switch to the Option Setup.

1 Search 2

COMPLETED 2

2 1.5P 2.In 0P 2



- If an FM station cannot be preset automatically due to poor reception, use the "Manual tuning" operation (☞ page 37) to tune in the station, then preset it using the manual "Preset memory" operation (☞ page 37).

System Setup

Option Setup

Setting the Power Amplifier Assignment

To suit your preference, a surround back channel's power amplifier can be assigned to the ZONE2.

1 Press $\triangleleft \triangleright$ to select "3. Op", then press **ENTER**.

2 Press $\triangleleft \triangleright$ to set.

S.Back:

The surround back speakers are used in MAIN ZONE.

ZONE2:

This mode assigns the surround back amplifier channels to provide ZONE2 speaker-level outputs from the surround back speaker terminals.

3 Press **ENTER** or ∇ to enter the setting and switch to the Volume Control setting.

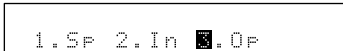
1 

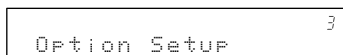

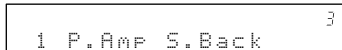
2 

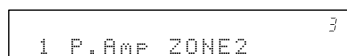

3 

Setting the Volume Control

This sets the volume level of output.

1 Press $\triangle \nabla$ to select the item, then press $\triangleleft \triangleright$ to set.

Volume Limit:

Set the volume's upper limit.

• **0 dB, -10 dB, -20 dB:**

The volume cannot be increased above the selected levels.

• **OFF:**

If you do not want to set a volume limit, select "OFF".

In this case, the volume can be set to the AVR-587's maximum volume (output) level of +18 dB, which is extremely loud.

Power On Volume Level:• **LAST:**

The volume set when the AVR-587 was last used is stored in the memory and set when the power is turned on.

• **--- (Mute):**

The volume is always muted when the power is turned on.

• **-80 dB ~ +18 dB:**

Set the volume level when the power is turned on.

You can adjust the MAIN ZONE volume level within the range of -80 to +18 dB (and ZONE2 volume level within the range of -70 to +18 dB).

Muting Level:

Set the level of volume attenuation in the mute mode.

• **FULL:**

The volume is fully muted.

• **-40 dB, -20 dB:**

The volume is lowered 40 dB or 20 dB from the current level.

2 Press **ENTER** or ∇ to enter the setting and switch to the Auto Surround Mode setting.

System Setup

1 

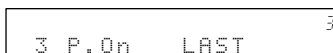

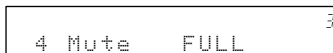

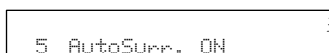
2 

System Setup

Setting the Auto Surround Mode

Set whether or not to store the surround mode last played for the input signal.

The surround mode used at last for the three types of input signals shown below is stored in the memory, and the signal is automatically played with that surround mode the next time it is input.

- ① Analog and PCM 2-channel signals (STEREO)
 - ② 2-channel signals of Dolby Digital, DTS or other multi-channel format (DOLBY PLIIx Cinema)
 - ③ Multi-channel signals of Dolby Digital, DTS or other multi-channel format (DOLBY/DTS SURROUND)
- ※ Default settings are indicated in ().

1 Press ◀ ▶ to set.

2 Press ENTER to enter the setting and switch to the Speaker Setup.

1 5 AutoSurr. OFF 3

2 1.5P 2.In 3.0P

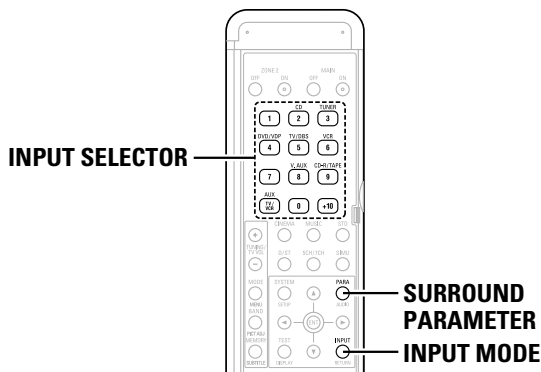
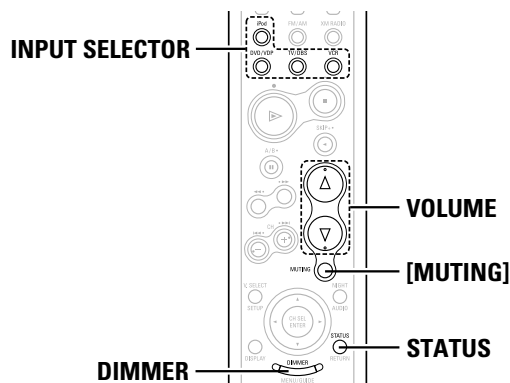
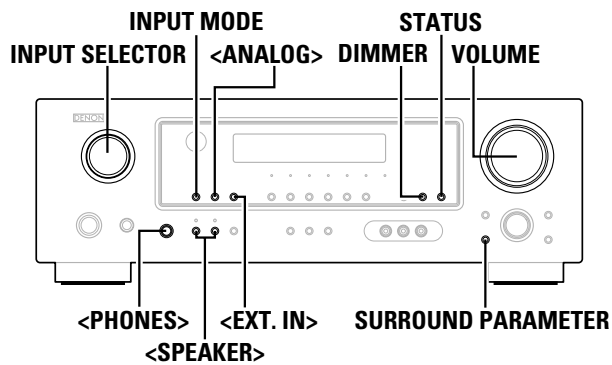

About the button names in this explanation
 < > : Buttons on the main unit
 [] : Buttons on the remote control unit
Button name only :
 Buttons on the main unit and remote control unit

Basic Operation

Playing the input source

1 Use **INPUT SELECTOR** to select the input source you want to play.

2 Press **INPUT MODE**.

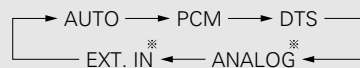

※ Press <ANALOG> to select "ANALOG", <EXT. IN> to select "EXT. IN".

AUTO (All auto mode):

The type of input signal is detected and the AVR-587's surround mode is switched automatically. Can be selected for sources for which the Digital In Assignment mode (page 21) is made. The mode switches automatically to DTS/ Dolby Digital/ PCM. The input switches to the analog input terminals if no digital signals are being input.

- The INPUT mode indicator lights.

PCM (exclusive PCM signal playback mode) and DTS (exclusive DTS signal playback mode):

Played when the various signals are input. Noise may be generated when a mode different from the input signal is set.

- The INPUT mode indicator lights.

ANALOG (exclusive analog audio signal playback mode) and EXT. IN (External decoder input terminal selection mode):

The signals input to the various input terminals are played.

- ※ To lower the subwoofer channel level in the EXT. IN mode, press **SURROUND PARAMETER** and select "SW. ATT". For some players the playback level of the SW channel may seem strong. If so, set to "ON".

3 Start playback on the selected component.

- ※ For operating instructions, refer to the component's manual.

4 Use **VOLUME** to adjust the volume.

- The volume level is displayed on the master volume level display.

- ※ The volume can be adjusted between the range of -80 ~ 0 ~ 18 dB. Depending on the channel level settings and the different surround mode settings and when in the down-mix mode, it may not be possible to adjust the volume to 18 dB.



- Canceling the EXT. IN mode:
Press **INPUT MODE** or <ANALOG> to switch to the desired input mode.
- To use the EXT. IN mode together with a picture, select the input source to which the video signal is connected first, then set the input mode.
- The "DIGITAL" indicator lights when digital signals are being input properly. If the "DIGITAL" indicator does not light, check whether the Digital In Assignment mode (page 21) and connections are correct.

NOTE:

- When the input mode is set to the external input (EXT. IN), the surround mode cannot be set.
- In play modes other than the external input mode, the signals connected to these terminals cannot be played.

Cautions when playing DTS sources:

- For DTS sources, be sure to connect the device to the digital input terminal and set "AUTO" or "DTS" for the input source. Noise will be generated if you play in the "ANALOG" or "PCM" mode.
- When playing DTS signals in the "AUTO" mode, noise may be generated when you first start playing and during searching. If so, play in the "DTS" mode.

Basic Operation

Turning the sound off temporarily (MUTING)

Press **[MUTING]**.

※ You can adjust the muting level (🔊 page 23).



• Canceling MUTING mode:

To cancel the muting mode, either press **[MUTING]** or adjust the volume.

Listening over headphones

Connect the headphones to **<PHONES>**.

• No sound is produced from the speakers automatically.

NOTE:

• To prevent hearing loss, be careful not to raise the volume level excessively when using headphones.

Switching the front speakers

Press **<SPEAKER>** to turn the corresponding speaker pair on.

※ The front speaker A, B setting can be also be changed with **<SPEAKER>**.

Checking the currently playing program source, etc.

Press **STATUS**.

• The current program source and various settings are indicated on the display.

Switching the brightness of the display

Press **DIMMER**.

※ The brightness of the display can be adjusted in three steps. The display can also be turned off.

Basic Operation

Using the surround modes

Types of surround modes and their features

The AVR-587 is equipped with many surround modes. We recommend using the surround modes as described below in order to achieve the maximum effect for the specific signal source.

※  is a 6.1-channel/7.1-channel surround mode.

Sources recorded in Dolby Digital EX

DOLBY DIGITAL EX / +PLIIx* (🔊 page 28)

• This mode is optimized for playing sources recorded in Dolby Digital EX.

Sources recorded in DTS-ES

DTS-ES DSCRT 6.1 / MTRX 6.1, +PLIIx* (🔊 page 28)

• This is the optimum mode for playing sources recorded in DTS-ES.

Dolby Digital or DTS Surround (5.1 ch sources)
2 ch sources recorded in Dolby Surround

**DOLBY DIGITAL / DOLBY DIGITAL+PLIIx* /
DTS SURROUND / DTS 96/24 / DTS+PLIIx* /
DTS+NEO:6** (🔊 page 28)

• This mode is optimized for playing 5.1-channel or 7.1-channel music.
• For Dolby Surround recording sources, Dolby Pro Logic II playback is conducted.

2-channel sources recorded in XM HD Surround

NEURAL SURROUND (🔊 page 30)

• This is the optimum mode for playing sources recorded in XM HD Surround.

Basic Operation

Sources recorded in stereo
Sources recorded in monaural

DIRECT / STEREO

- Effective for achieving pure playback.
- If there is no need for tone control or distribution of the low frequencies in function of the speaker configuration, select the DIRECT mode to achieve the best sound quality.

DENON Original Surround Modes (page 34, 35)

- Select these for 7.1-channel playback with sources recorded in stereo or monaural.
- The effects are different for each of the surround modes. Select the one most suited for the source being used.

DTS NEO:6 (page 30)

- This is a surround mode for playing 6.1- or 7.1-channel stereo sources developed by Digital Theater Systems.
- One of two playing modes, MUSIC (for music sources) or CINEMA (for movie sources), can be selected according to your preferences.

DOLBY PRO LOGIC IIx* (page 29)

- Developed by Dolby Laboratories, this surround mode provides 7.1-channel surround sound with conventional stereo (2-channel) sources.
- Select CINEMA mode for movie surround soundtracks, MUSIC for music sources, and GAME for 2-channel game box audio sources.



- Surround modes marked with an asterisk (*) cannot be used when the surround back speaker is set to "NONE".
- The "+PLIIx Cinema" mode cannot be selected when only one surround back speaker is being used.

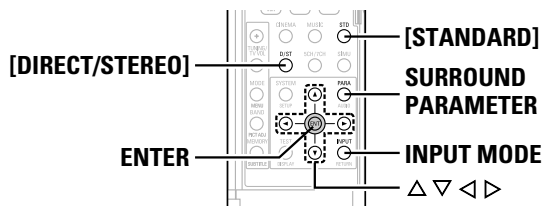
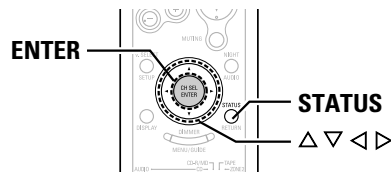
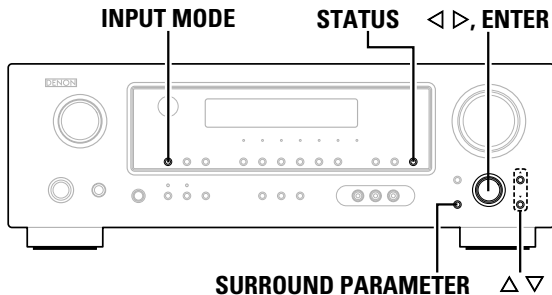

About the button names in this explanation
 < > : Buttons on the main unit
 [] : Buttons on the remote control unit
Button name only :
 Buttons on the main unit and remote control unit

Basic Operation

Selecting the play mode (DIRECT/STEREO)

The AVR-587 is equipped with two 2-channel playback modes exclusively for music. Select the mode to suit your tastes.

DIRECT mode

This mode is for playing with high quality sound. The audio signals are transmitted directly, without passing through the tone circuits, etc.

Press [DIRECT/STEREO] to select "DIRECT".

DIRECT ←→ STEREO

STEREO mode

Use this mode to adjust the tone and achieve the desired sound.

Press [DIRECT/STEREO] to select "STEREO".



Basic Operation

Selecting the Dolby Digital and DTS Surround mode (only with digital input)

1 Select an input source for which digital (COAXIAL or OPTICAL) is set (☞ page 21).

2 Press **INPUT MODE** to select "AUTO".

3 Press **[STANDARD]** to select "STANDARD (Dolby/DTS Surround)".

4 Play a program source with the ,  mark.
• "DIGITAL" or "DTS" lights, depending on the source.

5 Press **SURROUND PARAMETER**.

6 Press Δ ∇ to select the item, then press \triangleleft \triangleright to set.

※ The parameter switches as shown below each time the button is pressed.

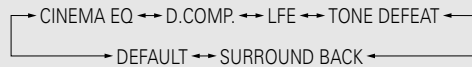

※ If you do want the bass and treble to be adjusted, turn off the tone defeat mode.

CINEMA EQ.:

Use this if movie dialogues sound harsh to lower the treble sound.

- ※ Effective source mode
Dolby Pro Logic IIx / Dolby Pro Logic / Dolby Digital /
DTS Surround / DTS NEO:6 / NEURAL SURROUND

D.COMP.:

The dynamic range is compressed. Select one of four modes: "OFF", "LOW", "MID" (middle) or "HIGH".

- ※ Effective source mode
Dolby Digital /
DTS (For DTS sources, only displayed for compatible software.)

LFE:

To play the various types of software properly, we recommend setting to the values shown below.

- To play Dolby Digital software: "0 dB"
- To play DTS movie software: "0 dB"
- To play DTS music software: "-10 dB"

TONE:

Adjust the tone control.

- ※ Can be set in surround modes other than direct mode.
- ※ Can be set separately for the different surround modes.
(Adjusted together for the Dolby/DTS SURROUND modes.)

SB CH OUT:

Select the play mode or surround back channel playback method.
• The surround back indicator lights.

(1) For multi-channel sources

- **SB OFF (OFF):**
Not played.
- **NON MTRX:**
Surround channel signal played.
- **MTRX ON:**
Surround channel signal played with digital matrix processing.
- **ES MTRX:**
DTS signal played with digital matrix processing.
- **ES DSCRT:**
Signal included in DTS-ES discrete 6.1-channel sources played.
- **PLIIx CINEMA:**
Decoded in Dolby Pro Logic IIx Cinema mode, surround back signal played.
※ Set the surround back speaker to "2sp" at Speaker Configuration mode (☞ page 19).
- **PLIIx MUSIC:**
Decoded in Dolby Pro Logic IIx Music mode, surround back signal played.
※ Set the surround back speaker to "1sp" or "2sp" at Speaker Configuration mode (☞ page 19).

Basic Operation

(2) For 2-channel sources

- **OFF:** Not played.
- **ON:** Surround channel signal played.

7 Press **ENTER** or **SURROUND PARAMETER**.



- Select "DEFAULT Y/N" and press \triangleleft to reset all the settings.

Dialog normalization function

This operates automatically when playing Dolby Digital sources. This is a function for automatically correcting the standard signal level for different program sources. The correction value can be checked by pressing **STATUS**.

Offset -4dB

The numbers are the correction value when corrected to the standard level.

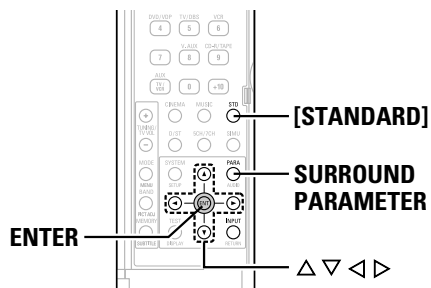
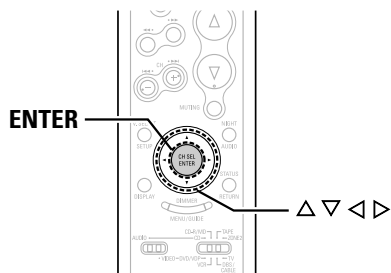
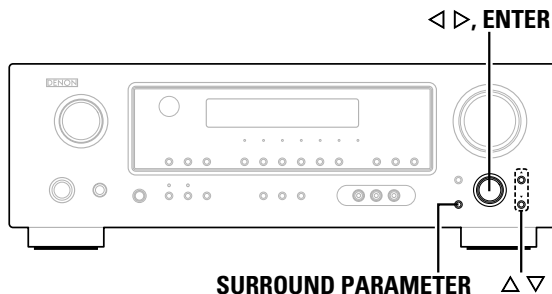

About the button names in this explanation
 < > : Buttons on the main unit
 [] : Buttons on the remote control unit
Button name only :
 Buttons on the main unit and remote control unit

Selecting the Dolby Pro Logic IIx (Pro Logic II) mode

It is possible to play analog input signals and digital input signals (2-channels) in the surround mode. This mode is optimal for playing program sources recorded in Dolby Surround.

1 Press [STANDARD] to select “DOLBY PLIIx”.

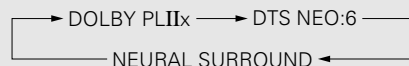

2 Play a program source.

3 Press SURROUND PARAMETER.

4 Press < > to select the play mode.

CINEMA:

This mode is suited for playing movie sources recorded in Dolby Surround and general sources recorded in stereo.

MUSIC:

This mode is suited for playing stereo music signals in the surround mode. With music signals, the sound field expansion differs according to the type of music, the recording conditions (live/studio), etc.. Because of this, the MUSIC mode offers a number of optional parameters for further adjusting the sound field.

GAME:

This mode is optimum for games. The GAME mode can only be used for 2-channel audio sources.

PL:

This mode is compatible with conventional Dolby Pro Logic sources.

5 Press Δ ∇ to select the item, then press < > to set.

* The mode switches as shown below each time the button is pressed.

• When the CINEMA mode:

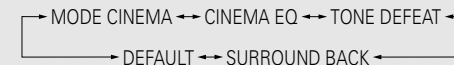

• When the MUSIC mode:

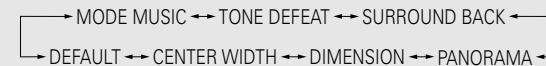

• When the GAME mode:

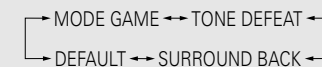

• When the DOLBY PRO LOGIC mode:

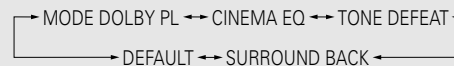

* If you do want the bass and treble to be adjusted, turn off the tone defeat mode.

When “MUSIC” mode is selected:

PANORAMA:

This is effective when the surround effect seems weak.

DIMENSION:

This shifts the center of the sound field image to the front or surround side. This compensates for when the sound field image seems unbalanced. (0 to 6, default : 3)

CENTER WIDTH:

A natural expansion to the front can be achieved by adjusting the center signal’s output balance between the center and front channels. (0 to 7, default : 3)

6 Press ENTER or SURROUND PARAMETER.

Basic Operation

Selecting the DTS NEO:6 mode

It is possible to play analog input signals and digital input signals (2-channels) in the surround mode.

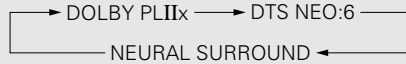
1 Press **[STANDARD]** to select “DTS NEO:6”.

2 Play a program source.

3 Press **SURROUND PARAMETER**.

4 Press **<>** to select the play mode.
CINEMA:

This mode is optimum for playing movies. Decoding is performed with emphasis on separation performance to achieve the same atmosphere with 2-channel sources as with 6.1-channel sources.

MUSIC:

This mode is suited mainly for playing music.

Basic Operation

Selecting the NEURAL SURROUND mode

It is possible to play analog input signals and digital input signals (2-channels) in the surround mode.

This is the optimum mode for playing sources recorded in XM HD Surround (page 38).

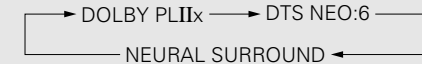
1 Press **[STANDARD]** to select “NEURAL SURROUND”.

2 Play a program source.

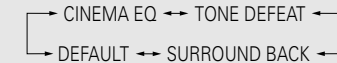
3 Press **SURROUND PARAMETER**.

4 Press **<>** to select the item, then press **<>** to set.

5 Press **ENTER** or **SURROUND PARAMETER**.

5 Press **<>** to select the item, then press **<>** to set.

* The mode switches as shown below each time the button is pressed.

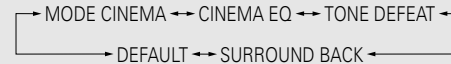
- When the CINEMA mode:



- When the MUSIC mode:

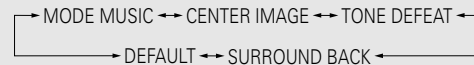

* If you do want the bass and treble to be adjusted, turn off the tone defeat mode.

When “MUSIC” mode is selected:

CNTR. IMAGE:

The expansion of the center channel can be adjusted. (0.0 to 1.0, default : 0.3)

6 Press **ENTER** or **SURROUND PARAMETER**.

Surround modes and parameters

Surround Mode	Signals and adjustability in the different modes																			
	Channel output					Parameter (default values are shown in parentheses)														
	FRONT L/R	CENTER	SURROUND L/R	SURROUND BACK L/R	SUB-WOOFER	D. COMP *1	LFE *2	SB CH OUT	TONE CONTROL	CINEMA EQ.	MODE	ROOM SIZE	EFFECT LEVEL	Dolby Digital NIGHT mode	DELAY TIME	PRO LOGIC II/IIx MUSIC MODE only			NEO:6 MUSIC MODE only	EXT. IN only
															PANORAMA	DIMENSION	CENTER WIDTH	CENTER IMAGE	SW ATT	
STEREO	○	×	×	×	⊙	○ (OFF)	○ (0 dB)	×	○ (0 dB)	×	×	×	×	○ (OFF)	×	×	×	×	×	×
EXT. IN	○	⊙	⊙	⊙	⊙	×	×	×	×	×	×	×	×	×	×	×	×	×	×	○
DOLBY PRO LOGIC IIx	○	⊙	⊙	⊙	⊙	○ (OFF)	×	○	○ (0 dB)	○ (NOTE 2)	○ (CINEMA)	×	×	○ (OFF)	×	○ (OFF)	○ (3)	○ (3)	×	×
DOLBY PRO LOGIC II	○	⊙	⊙	×	⊙	○ (OFF)	×	○	○ (0 dB)	○ (NOTE 3)	○ (CINEMA)	×	×	○ (OFF)	×	○ (OFF)	○ (3)	○ (3)	×	×
DTS NEO:6	○	⊙	⊙	⊙	⊙	○ (OFF)	×	○	○ (0 dB)	○ (NOTE 2)	○ (CINEMA)	×	×	○ (OFF)	×	×	×	×	○ (0.3)	×
DOLBY DIGITAL	○	⊙	⊙	⊙	⊙	○ (OFF)	○ (0 dB)	○	○ (0 dB)	○ (OFF)	×	×	×	○ (OFF)	×	×	×	×	×	×
DTS SURROUND	○	⊙	⊙	⊙	⊙	○ (OFF)	○ (0 dB)	○	○ (0 dB)	○ (OFF)	×	×	×	×	×	×	×	×	×	×
NEURAL SURROUND	○	⊙	⊙	⊙	⊙	×	×	○	○	○	×	×	×	×	×	×	×	×	×	×
5CH/7CH STEREO	○	⊙	⊙	⊙	⊙	○ (OFF)	○ (0 dB)	○	○ (0 dB)	×	×	×	×	○ (OFF)	×	×	×	×	×	×
MONO MOVIE	○	⊙	⊙	⊙	⊙	○ (OFF)	○ (0 dB)	○	○ (0 dB)	×	×	○ (Medium)	○ (10)	○ (OFF)	×	×	×	×	×	×
ROCK ARENA	○	⊙	⊙	⊙	⊙	○ (OFF)	○ (0 dB)	○	○ (NOTE 1)	×	×	○ (Medium)	○ (10)	○ (OFF)	×	×	×	×	×	×
JAZZ CLUB	○	⊙	⊙	⊙	⊙	○ (OFF)	○ (0 dB)	○	○ (0 dB)	×	×	○ (Medium)	○ (10)	○ (OFF)	×	×	×	×	×	×
VIDEO GAME	○	⊙	⊙	⊙	⊙	○ (OFF)	○ (0 dB)	○	○ (0 dB)	×	×	○ (Medium)	○ (10)	○ (OFF)	×	×	×	×	×	×
MATRIX	○	⊙	⊙	⊙	⊙	○ (OFF)	○ (0 dB)	○	○ (0 dB)	×	×	×	×	○ (OFF)	○ (30 msec)	×	×	×	×	×
VIRTUAL	○	×	×	×	⊙	○ (OFF)	○ (0 dB)	×	○ (0 dB)	×	×	×	×	○ (OFF)	×	×	×	×	×	×

○ : Signal
 × : No signal
 ⊙ : Turned on or off by speaker configuration setting

○ : Adjustable
 × : Not adjustable
 NOTE 1 : BASS +6 dB, TREBLE +4 dB
 NOTE 2 : This parameter is available when the "MODE" is set to "CINEMA".
 NOTE 3 : This parameter is available when the "MODE" is set to "CINEMA" or "PL".
 *1: When playing Dolby Digital and DTS signals.
 *2: When playing Dolby Digital, DTS, DVD-Audio and Super Audio CD.

○ : Signal
 × : No signal

○ : Adjustable
 × : Not adjustable

□ Differences in surround mode names depending on the input signals

Button	Surround Mode	Note	Input signals													
			ANALOG	LINEAR PCM	DTS				DOLBY DIGITAL					DVD-AUDIO		
					DTS ES DSCRT (With Flag)	DTS ES MTRX (With Flag)	DTS (5.1ch)	DTS 96/24	DOLBY DIGITAL EX (With Flag)	DOLBY DIGITAL EX (With no Flag)	DOLBY DIGITAL (5.1ch)	DOLBY DIGITAL (3, 4, 5ch)	DOLBY DIGITAL (2ch)	DVD-Audio (multi ch)	DVD-Audio (2ch)	176.4/ 192kHz
STANDARD																
DTS SURROUND																
	DTS ES DSCRT6.1	*1	X	X	●	X	X	X	X	X	X	X	X	X	X	X
	DTS ES MTRX6.1	*1	X	X	X	●	X	X	X	X	X	X	X	X	X	X
	DTS SURROUND		X	X	○	○	●	X	X	X	X	X	X	X	X	X
	DTS 96/24		X	X	X	X	●	X	X	X	X	X	X	X	X	X
	DTS + PLIIx CINEMA	*2	X	X	○	○	○	○	X	X	X	X	X	X	X	X
	DTS + PLIIx MUSIC	*1	X	X	○	○	○	○	X	X	X	X	X	X	X	X
	DTS + NEO:6	*1	X	X	X	○	○	○	X	X	X	X	X	X	X	X
	DTS NEO:6 CINEMA		○	○	X	X	X	X	X	X	X	X	○	X	○	X
	DTS NEO:6 MUSIC		○	○	X	X	X	X	X	X	X	X	○	X	○	X
DOLBY SURROUND																
	DOLBY DIGITAL EX	*1	X	X	X	X	X	X	○	○	○	○	X	X	X	X
	DOLBY DIGITAL		X	X	X	X	X	X	○	●	●	●	X	X	X	X
	DOLBY DIGITAL+PLIIx CINEMA	*2	X	X	X	X	X	X	●	○	○	○	X	X	X	X
	DOLBY DIGITAL+PLIIx MUSIC	*1	X	X	X	X	X	X	○	○	○	○	X	X	X	X
	DOLBY PRO LOGIC IIx CINEMA		○	○	X	X	X	X	X	X	X	X	●	X	○	X
	DOLBY PRO LOGIC IIx MUSIC		○	○	X	X	X	X	X	X	X	X	○	X	○	X
	DOLBY PRO LOGIC IIx GAME		○	○	X	X	X	X	X	X	X	X	○	X	○	X
	DOLBY PRO LOGIC II CINEMA		○	○	X	X	X	X	X	X	X	X	○	X	○	X
	DOLBY PRO LOGIC II MUSIC		○	○	X	X	X	X	X	X	X	X	○	X	○	X
	DOLBY PRO LOGIC II GAME		○	○	X	X	X	X	X	X	X	X	○	X	○	X
	DOLBY PRO LOGIC		○	○	X	X	X	X	X	X	X	X	○	X	○	X
	NEURAL SURROUND		○	○	X	X	X	X	X	X	X	X	X	X	○	X

- : Mode selectable in default status
- : Selectable mode
- X : Non-selectable mode

NOTE :

- *1: This mode is not available when the Surround Back speaker setup is set to "None".
- *2: This mode is not available when the Surround Back speaker setup is set to "1sp" or "None".

Basic Operation

Basic Operation

Button	Surround Mode	Note	Input signals														
			ANALOG	LINEAR PCM	DTS				DOLBY DIGITAL					DVD-AUDIO			
					DTS ES DSCRT (With Flag)	DTS ES MTRX (With Flag)	DTS (5.1ch)	DTS 96/24	DOLBY DIGITAL EX (With Flag)	DOLBY DIGITAL EX (With no Flag)	DOLBY DIGITAL (5.1ch)	DOLBY DIGITAL (3, 4, 5ch)	DOLBY DIGITAL (2ch)	DVD-Audio (multi ch)	DVD-Audio (2ch)	176.4/ 192kHz	
DIRECT	DIRECT		○	○	○	○	○	○	○	○	○	○	○	○	×	○	○
DSP SIMULATION	5CH/7CH STEREO	*1	○	○	○	○	○	○	○	○	○	○	○	○	○	×	×
	MONO MOVIE		○	○	○	○	○	○	○	○	○	○	○	○	○	×	×
	ROCK ARENA		○	○	○	○	○	○	○	○	○	○	○	○	○	×	×
	JAZZ CLUB		○	○	○	○	○	○	○	○	○	○	○	○	○	×	×
	VIDEO GAME		○	○	○	○	○	○	○	○	○	○	○	○	○	×	×
	MATRIX		○	○	○	○	○	○	○	○	○	○	○	○	○	×	×
	VIRTUAL		○	○	○	○	○	○	○	○	○	○	○	○	○	×	×
STEREO	STEREO		●	●	○	○	○	○	○	○	○	○	○	○	○	●	●

- : Mode selectable in default status
- : Selectable mode
- ×

NOTE :

*1: If the Surround Back speaker setup is set to "None", then "5CH STEREO" is displayed.

Using the DENON original surround modes

The AVR-587 is equipped with a high performance digital signal processor (DSP) that uses digital signal processing to recreate sound fields artificially. One of seven surround modes can be selected according to the program source and parameters can be further adjusted to achieve even more realistic sound fields.

Types of surround modes and their features

5CH/7CH STEREO (NOTE 1)	This mode lets you enjoy stereo sound with seven speakers. The front L (R) channel signals are played from the surround and surround back L (R) channels and only the in-phase component of the L and R channels is played on the center channel.
MONO MOVIE (NOTE 2)	This mode recreates the atmosphere of an expansive sound field for movie sources recorded in monaural.
ROCK ARENA	This mode recreates the atmosphere of a live concert in an arena.
JAZZ CLUB	This mode recreates the atmosphere of a live concert in a club with low ceilings, hard walls and the artist just in front of you.
VIDEO GAME	This mode provides a rich sense of presence for video games.
MATRIX	This mode recreates music sources recorded in stereo with an enhanced sense of expansion.
VIRTUAL	This mode can be used to enjoy surround sound with only front speakers or when using headphones.

NOTE 1: "5CH STEREO" is displayed when "SB CH OUT" is set to "OFF".

NOTE 2: When playing sources recorded in monaural, the sound will be one-sided if signals are only input to one channel (left or right), so input signals to both channels. If you have a source component with only one audio output (monophonic camcorder, etc.) obtain a "Y" adapter cable to split the mono output to two outputs, and connect to the L and R inputs.



- Depending on the program source being played, the effect may not be very noticeable. In this case, try other surround modes, without worrying about their names, to create a sound field suited to your tastes.

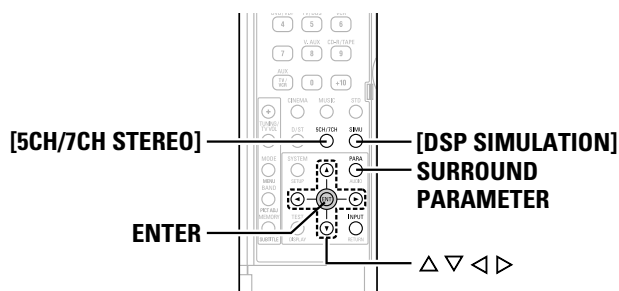
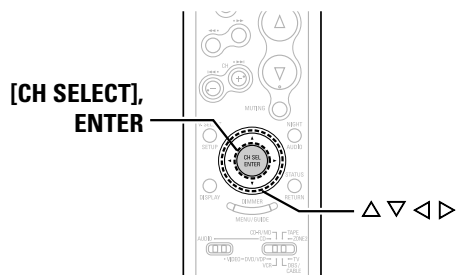
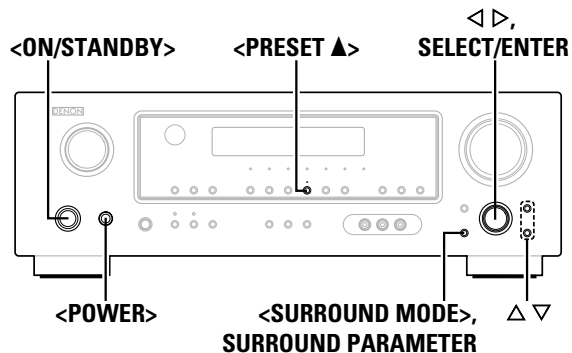

About the button names in this explanation
 < > : Buttons on the main unit
 [] : Buttons on the remote control unit
Button name only :
 Buttons on the main unit and remote control unit

Selecting the DSP surround simulation

To operate the surround mode and the surround parameters from the remote control unit

1 Press **[DSP SIMULATION]**.

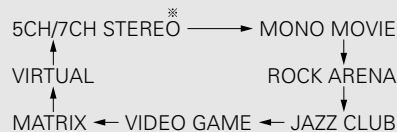

* The 5CH/7CH STEREO mode can be selected directly by pressing **[5CH/7CH STEREO]**.

2 Press **SURROUND PARAMETER**.

3 Press Δ ∇ to select the item, then press \triangleleft \triangleright to set.

* The surround parameter switches in the following order each time **[SURROUND PARAMETER]** is pressed for the different surround modes.

• When the MONO MOVIE, ROCK ARENA, JAZZ CLUB and VIDEO GAME mode:

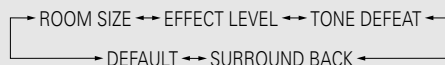

• When the MATRIX mode:

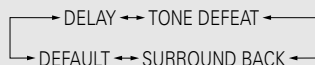

• When the VIRTUAL mode:

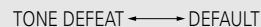

* If you do want the bass and treble to be adjusted, turn off the tone defeat mode.

SB CH OUT

- **ON:**
Surround back channel played.
- **OFF:**
Surround back channel not played.

ROOM SIZE:

Adjust the imaginary size of the recreated sound field space. (Does not express size of room in which played.)
 There are five parameters: "small", "med.s", "medium", "med.l" and "large".

EFFECT LEVEL:

Adjust the strength of the surround effect.

DELAY TIME: (MATRIX mode only)

Adjust the delay time between "0 ms" and "110 ms".

4 Press **ENTER** or **SURROUND PARAMETER**.



- Select "DEFAULT Y/N" and press \triangleleft to reset all the settings.

Operating the surround mode and the surround parameters from the main unit's panel

1 Use **<SELECT/ENTER>** to select the surround mode.

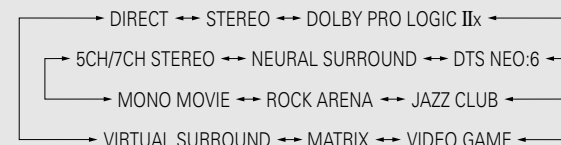

* To select the surround mode while adjusting the surround parameters, tone defeat or tone control, press **<SURROUND MODE>**, then operate the selector.

2 Perform steps 2 to 4 under "Selecting the DSP surround simulation".

Basic Operation

Setting the tone control

Adjust the bass and treble to suit your tastes.

Adjusting the tone

1 Press **SURROUND PARAMETER**.

2 Press $\Delta \nabla$ to select **"TONE DEF. ON"**.

※ In the direct mode, "TONE" cannot be selected.

3 Press \triangleright to select **"OFF"**.

4 Press $\Delta \nabla$ to select **"Bass"** or **"Treble"**, then press $\triangleleft \triangleright$ to set the level.

※ Can be adjusted within the range of -10 dB to +10 dB.

5 Press **ENTER** or **SURROUND PARAMETER**.

1 ROOM SIZE MED

2 TONE DEF. ON

3 TONE DEF. OFF

4 BASS 0dB

TREBLE 0dB

When you do not want to adjust the tone

Set **"Tone Defeat"** to **"ON"** at step 3 in **"Adjusting the tone"**.

Adjusting the speaker volume

1 Press **[CH SELECT]**.

2 Press **[CH SELECT]** to select the speaker.

※ The settable speaker switches each time this button is pressed.

3 Press $[\triangleleft \triangleright]$ to adjust the volume.

※ The SW channel level can be turned off by decreasing it one step from -12.0 dB.

OFF \leftrightarrow -12.0 dB \leftrightarrow +12.0 dB

Basic Operation

Listening to the radio

Check that the remote control unit is set to "AUDIO".

Auto preset memory

This unit is equipped with a function for automatically searching for FM broadcast stations and storing them in the preset memory.

1 Switch off the unit using **<POWER>**.

2 Hold **<PRESET \blacktriangle >** and press **<POWER>**.

- The unit automatically begins searching for FM broadcast stations.

※ When the first FM broadcast station is found, that station is stored in the preset memory at channel A1.

Subsequent stations are automatically stored in order at preset channels A1 to A8, B1 to B8, C1 to C8, D1 to D8, E1 to E8, F1 to F8 and G1 to G8 for a maximum of 56 stations.

※ Channel A1 is tuned in after the auto preset memory operation is completed.



- If an FM station cannot be preset automatically due to poor reception, use the "Manual tuning" operation to tune in the station, then preset it using the manual "Preset memory" operation.

- To interrupt this function, press **<ON/STANDBY>**.

Default settings

Auto tuner presets	
A1 ~ A8	87.5 / 89.1 / 98.1 / 107.9 / 90.1 / 90.1 / 90.1 / 90.1 MHz
B1 ~ B8	520 / 600 / 1000 / 1400 / 1500 / 1710 kHz, 90.1 / 90.1 MHz
C1 ~ C8	90.1 MHz
D1 ~ D8	90.1 MHz
E1 ~ E8	90.1 MHz
F1 ~ F8	90.1 MHz
G1 ~ G8	90.1 MHz

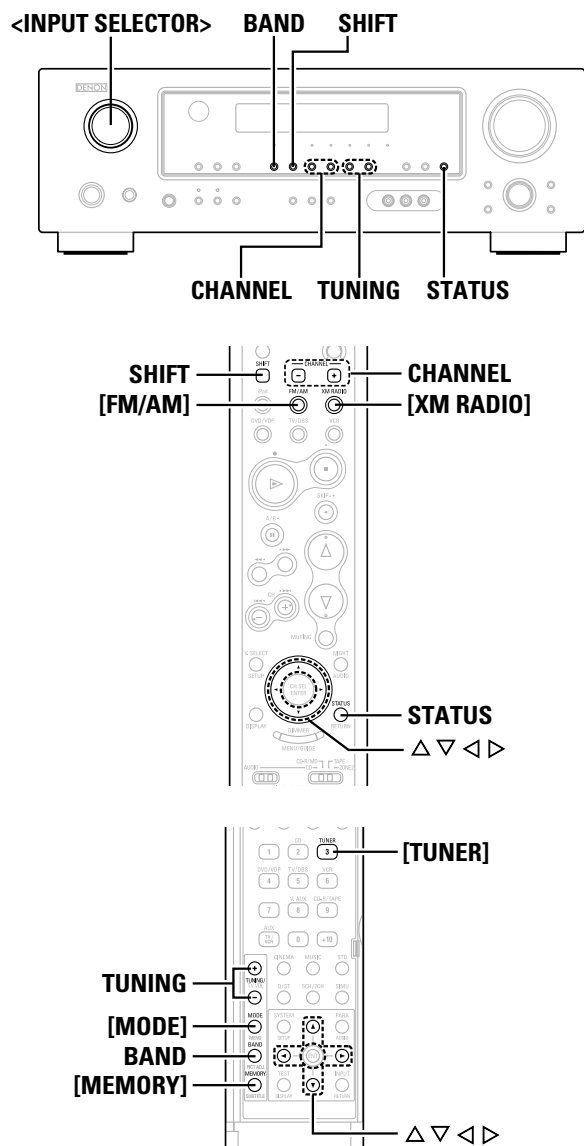

About the button names in this explanation
 < > : Buttons on the main unit
 [] : Buttons on the remote control unit
Button name only :
 Buttons on the main unit and remote control unit

Auto tuning

- 1** Use <INPUT SELECTOR> to select “TUNER” or press [TUNER].
- 2** Press BAND to select “AM”, “FM” or “XM”.
 ※ When listening to the XM Satellite Radio (☞ page 38).
- 3** Press [MODE] to set the auto tuning mode.
 • The “AUTO” indicator lights.
- 4** Press TUNING.
 • Automatic searching begins.



- If tuning does not stop at the desired station, use to the “Manual tuning” operation.
- “AM” or “FM” can be selected directly by pressing [FM/AM].

Manual tuning

- 1** Use <INPUT SELECTOR> to select “TUNER” or press [TUNER].
- 2** Press BAND to select “AM”, “FM” or “XM”.
 ※ When listening to the XM Satellite Radio (☞ page 38).
- 3** Press [MODE] to set the manual tuning mode.
 ※ Check that the display’s “AUTO” indicator turns off.
- 4** Press TUNING.
 ※ The frequency changes continuously when the button is held in.



- When the manual tuning mode is set, FM stereo broadcasts are received in monaural and the “STEREO” indicator turns off.
- “AM” or “FM” can be selected directly by pressing [FM/AM].

Preset memory

- 1** Use the “Auto tuning” or “Manual tuning” operation to tune in the station to be preset in the memory.
- 2** Press [MEMORY].
- 3** Press SHIFT to select the desired memory block (A to G).
- 4** Press CHANNEL to select the desired preset channel (1 to 8).
- 5** Press [MEMORY] again.
 • Store the station in the preset memory.



- To preset other channels, repeat steps 2 to 5.
 A total of 56 broadcast stations can be preset — 8 stations (channels 1 to 8) in each of blocks A to G.
- The memory block can also be selected by pressing SHIFT.

Recalling preset stations

- 1** Press SHIFT to select the memory block.
- 2** Press CHANNEL to select the desired preset channel.

Basic Operation

XM Satellite Radio

AVR-587 is the XM Ready receiver. You can receive XM® Satellite Radio by connecting to the XM Passport System (sold separately) and subscribing to the XM service.

Introducing XM Satellite Radio

There's a world of audio listening pleasure beyond AM and FM. XM Satellite Radio. Select from over 170 channels of music, news, sports, comedy, talk, and entertainment. Coast-to-coast coverage. Digital quality sound. With all music channels 100% commercial free.

Questions?: Visit www.xmradio.com.

How to Subscribe

Listeners can subscribe by visiting XM on the Web at www.xmradio.com or by calling XM's Listener Care at (800) 967-2346. Customers should have their Radio ID and credit card ready. The Radio ID can be found by selecting channel 0 on the radio.

A Warning Against Reverse Engineering

It is prohibited to copy, decompile, disassemble, reverse engineer, or manipulate any technology incorporated in receivers compatible with the XM Satellite Radio system. Furthermore, the AMBE® voice compression software included in this product is protected by intellectual property rights including patent rights, copyrights, and trade secrets of Digital Voice Systems, Inc. The user of this or any other software contained in an XM Radio is explicitly prohibited from attempting to copy, decompile, reverse engineer, or disassemble the object code, or in any other way convert the object code into human-readable form. The software is licensed solely for use within this product.

Hardware and required \$12.95 monthly service subscription sold separately. Other fees and taxes, including a one-time activation fee may apply. Subscription fee is consumer only. All fees and programming subject to change. Channels with frequent explicit language are indicated with an XL. Channel blocking is available for XM radio receivers by calling 1-800-XMRADIO. Subscriptions subject to Customer Agreement available at xmradio.com. XM service only available in the 48 contiguous United States. ©2006 XM Satellite Radio Inc. All rights reserved.

Checking the XM signal strength and Radio ID

1 Use **<INPUT SELECTOR>** to select "TUNER" or press **[TUNER]**.

2 Press **BAND** to select "XM".

3 Press **STATUS** until "SIGNAL" is displayed.
 • The display changes as shown below according to the receiving condition.

Display	Condition
GOOD	Signal strength is good
MARGINAL	Signal strength is marginal
WEAK	Signal strength is poor
NO	Loss of the signal

4 Adjust the antenna location until "SIGNAL:GOOD" is displayed.

5 Press **STATUS** until the XM channel (ex.XM001) is displayed.

6 Press **TUNING** to select channel 0 (XM000).



Basic Operation

Channel selection

1 Use **<INPUT SELECTOR>** to select "TUNER" or press **[TUNER]**.

2 Press **BAND** to select "XM".

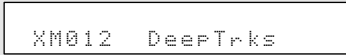

3 Press **TUNING** to reach the desired channel.
 ※ The channel changes continuously when you press and hold **TUNING**.
 ※ When the artist name and song title are received, they are displayed.

Category search

1 Press **< >** in the XM mode.
 • The current category name is displayed.



2 Press **< >** to select the category, and press **Δ ∇** to select the channel within the selected category.



- "LOADING" is displayed while receiving the channel or information.
- "UPDATING" is displayed while updating encryption code.
- When the selected channel is not available, "XM ---" is displayed.
- Information on the artist name, song title, category and signal level can be checked using **STATUS**.
- The XM Satellite Radio channels can be preset in the same way as AM/FM band (see page 37).
- "XM" can be selected directly by pressing **[XM RADIO]**.

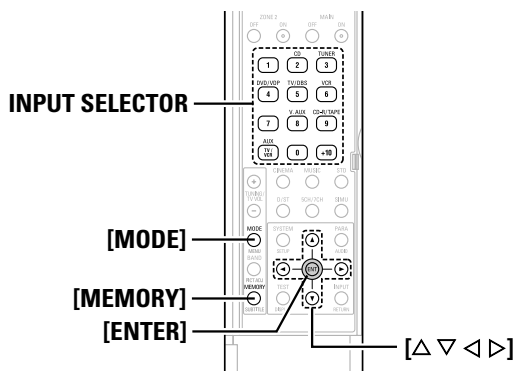
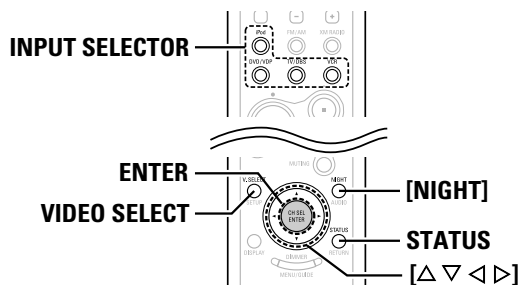
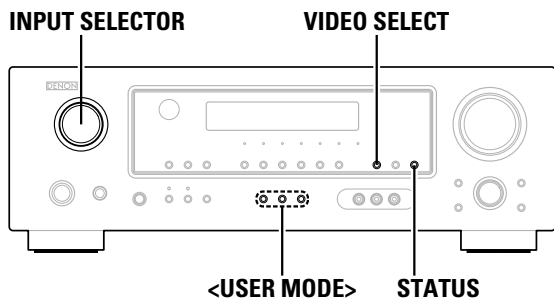

About the button names in this explanation
 < > : Buttons on the main unit
 [] : Buttons on the remote control unit
Button name only :
 Buttons on the main unit and remote control unit

Advanced Operation

Night mode

The night mode can be set when playing Dolby Digital sources. The dialogues are easier to hear at night and when listening with the volume low.

Press [NIGHT].



- Canceling night mode:
Press [NIGHT] again.
- When the night mode is set to "ON", the "D.COMP" surround parameter can not be selected.

User mode function

The AVR-587 is equipped with a function for storing the selected input source, the auto surround mode and input mode in the memory and selecting these settings when you want to use them.

Storing the settings in the memory

1 The following are stored in the memory:

- ① Currently set input source
- ② Currently set surround mode
- ③ Currently set input mode

2 Press <USER MODE> until "Memory" is displayed.

Calling the settings out

Press <USER MODE> at which the settings you want to call out are stored.

Combining the currently playing sound with the desired image (VIDEO SELECT function)

Press VIDEO SELECT until the desired image appears on the monitor.



- To cancel, press VIDEO SELECT to select "SOURCE".
- The video source selected with the video select function is stored in the memory for the different input sources.

Personal memory plus function

The surround mode last selected and the input mode setting are stored individually for the different input sources.

- ※ The surround parameters, tone control settings and playback level balance for the different output channels are memorized for each surround mode.

Advanced Operation

Playing the iPod®

The music recorded on the iPod can be played when using a Control Dock for iPod (ASD-1R, sold separately). The iPod can be controlled using the buttons on the main unit and the remote control unit.



iPod is a trademark of Apple Computer, Inc., registered in the U.S. and other countries.

- ※ With the iPod, non-copyrighted contents and contents that may be legally reproduced or played may be reproduced and played by individuals for their personal use. Violating copyrights is prohibited by law.

1 Connect the AVR-587 and iPod using the Control Dock for iPod (ASD-1R) (☞ page 14).

2 Assign the input terminal at “Setting the iPod Assignment” (☞ page 22).

3 Use INPUT SELECTOR to select the function assigned in step 2.

- Display “Remote iPod” on the main unit’s display.

Remote iPod

- ※ If the screens above are not displayed, the iPod may not be properly connected. Check the connections and settings.

4 Operate using [△ ▽ ◀ ▶] and [ENTER] while watching the iPod’s screen.



- The optional standard Control Dock for iPod is DENON ASD-1R sold separately.

NOTE:

- DENON will accept no responsibility whatsoever for loss or damage of data on an iPod occurring when the iPod is used connected to the AVR-587.
- Some of the functions may not operate, depending on the type of iPod and the software version.

Listening to music in the Browse mode

1 Press [△ ▽] to select the music file, then press [ENTER] or [▶].

- ※ Press [◀] to return to the music menu screen.

2 Press [ENTER] or [▶].

- Playback starts.

Pause:

- Press [ENTER] during playback.
- Press again to resume.

Manual search:

- Press and hold in [△ ▽] during playback.
- △: Fast reverse
- ▽: Fast forward

Track search:

- Press [△ ▽] during playback.
- △: Move to beginning of previous track
- ▽: Move to beginning of next track

Stop:

- Press [ENTER] for at least 2 seconds during playback.

Repeat play:

- Press [MODE].
- The mode switches as follows each time [MODE] is pressed.
- **RPT One:** Single track repeat
- **RPT All:** All track repeat

Shuffle play:

- Press [MEMORY].
- The mode switches as follows each time [MEMORY] is pressed.
- **SFL Songs:** Single track shuffle
- **SFL Albums:** Album shuffle

- ※ The mode switches between the Remote mode and the Browse mode if [MODE] is pressed for at least 2 seconds.
- In the Remote mode, only [△ ▽ ◀ ▶] and [ENTER] can be used.



- When **STATUS** is pressed during playback, the front panel display switches between the title name, artist name and album name.
- Depending on the iPod’s software version, it may not be possible to operate the iPod from the AVR-587. Use the latest version of the software. Information on the latest version of the software can be obtained on the Apple Computer website.
- With the AVR-587 it is possible to display folder names and file names on the screen like titles. The AVR-587 can display up to 64 characters, consisting of numbers, capital letters and small letters. A “?” mark is displayed in place of non-compatible characters.

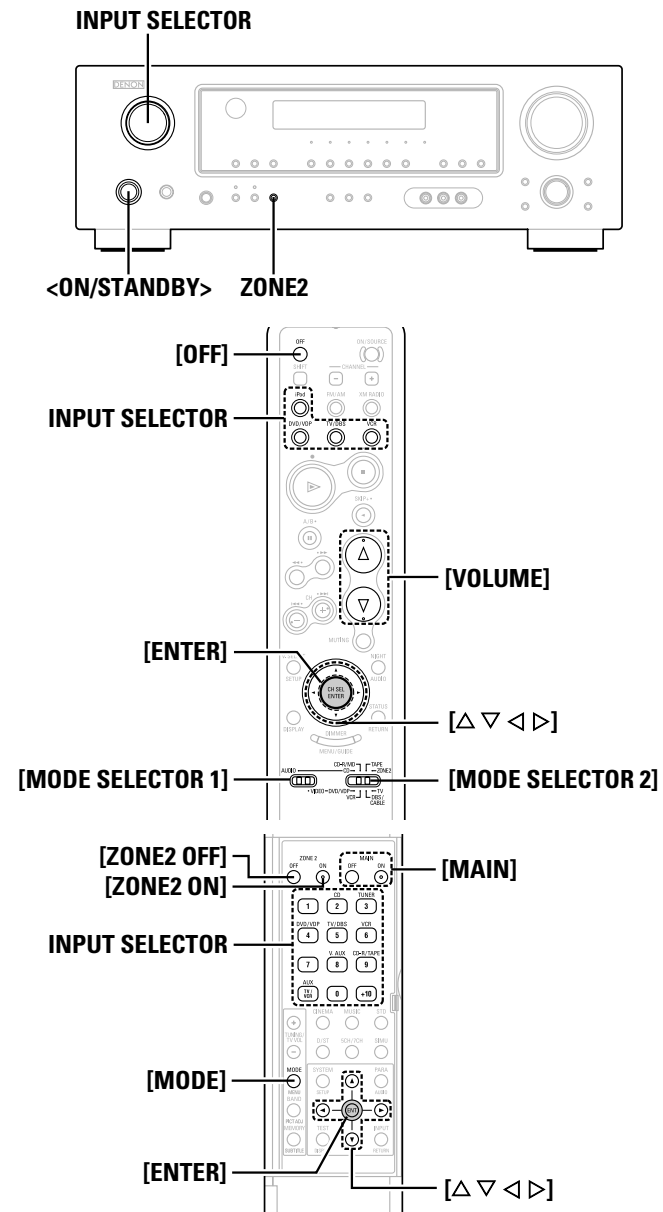

About the button names in this explanation
 < > : Buttons on the main unit
 [] : Buttons on the remote control unit
Button name only :
 Buttons on the main unit and remote control unit

Viewing still pictures and videos (only for iPods equipped with the slideshow / video function)

Use this procedure to view photo and video data stored on the iPod on a monitor.

1 Press [MODE] for at least 2 seconds to switch from the Browse mode to the Remote mode.
 • "Remote iPod" is displayed on the AVR-587's display.

2 Watching the iPod's screen, press [Δ ∇] to select "Photos" or "Video", then press [ENTER] or [▶].
 • The iPod's photo and video data are displayed on the monitor.



• To output photo or video data recorded on the iPod to the monitor, the iPod's "TV Out" setting (under "Video Settings") must be set to "ON".
 For details, refer to the iPod's operating instructions.

Disconnecting the iPod

Press <ON/STANDBY> or [OFF] and set the AVR-587's power to the standby mode.

※ The iPod can be disconnected after switching to a function other than the one to which the iPod input is assigned.

Advanced Operation

Multi zone music entertainment system

- ZONE2 speaker out can be used when "ZONE2" is selected at "Power Amp Assignment". In this case, surround back speaker out cannot be used for MAIN ZONE.



- For instructions on installation and operation of separately sold devices, refer to the devices' operating instructions.
- The main zone output can be turned on and off with **[MAIN]**.

When using the SURR.BACK/ZONE2 amplifier as the ZONE2

- To use the ZONE2, turn on **ZONE2**.
- The output of the ZONE2 SPEAKER OUT terminals can be adjusted with the remote control unit's **[VOLUME](ZONE2)**.
- The input source selected with **INPUT SELECTOR** is output for the ZONE2 speaker output.

[System configuration and connections example]

Using this unit's internal amplifier as the ZONE2.

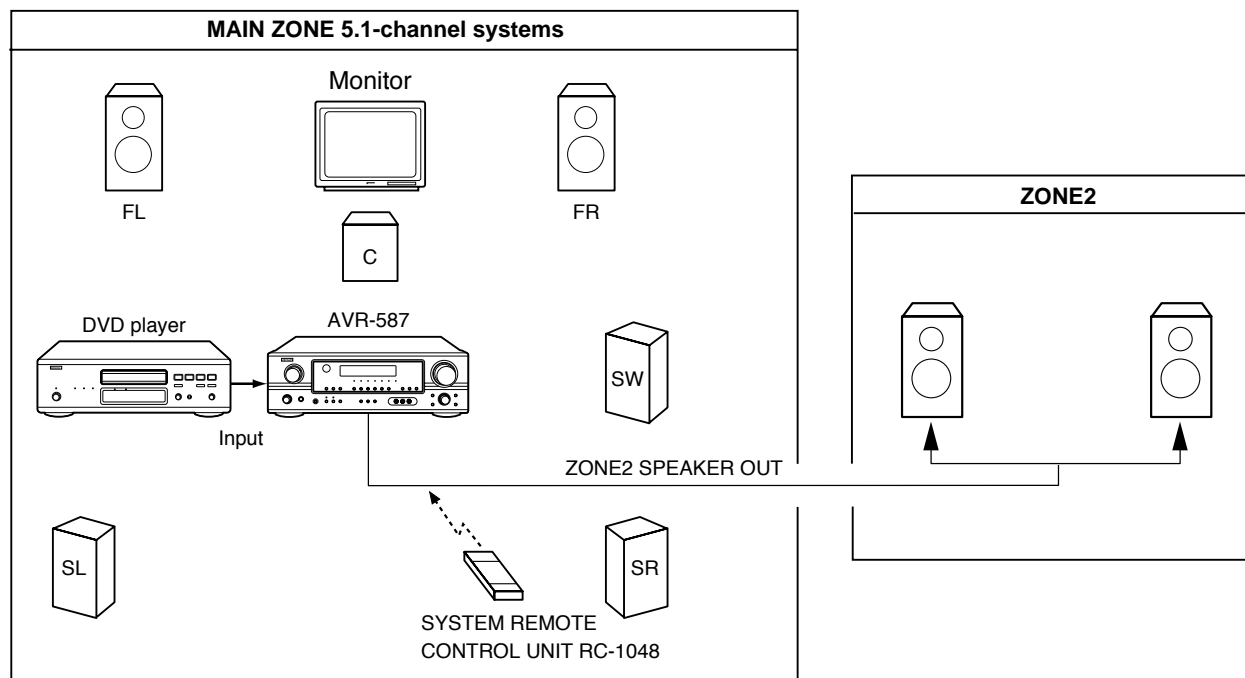

— : Speaker cable

※ Refer to "Connections" (page 14).

Advanced Operation

Remote control unit operations during multi-source playback (selecting the source)

This is only possible when the main unit in the ZONE2 mode (page 23).

1 Set **[MODE SELECTOR 1]** to the "AUDIO".

2 Set **[MODE SELECTOR 2]** to the "ZONE2".

3 Press **[ZONE2 ON]**.
 • The ZONE2 indicator lights.

※ To cancel the ZONE2 mode:
 Press **[ZONE2 OFF]**.

4 The output level of the ZONE2 SPEAKER OUT terminals can be controlled pressing **[VOLUME]**.

※ Default setting (ZONE2 volume level):
 --- dB (Minimum)



- The input source selected for the main zone is output to ZONE2.

INPUT SELECTOR

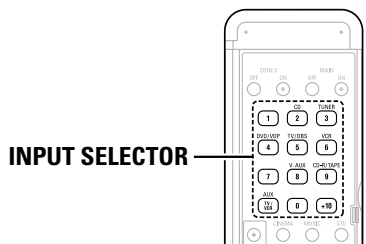
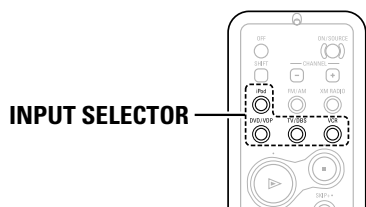
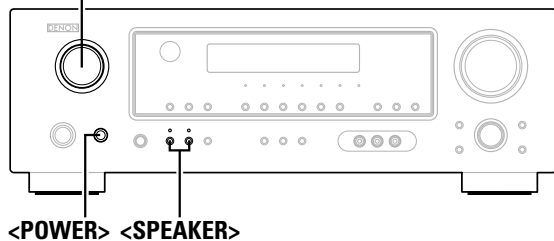

About the button names in this explanation
 < > : Buttons on the main unit
 [] : Buttons on the remote control unit
Button name only :
 Buttons on the main unit and remote control unit

Recording the program source (recording the source currently being monitored)

- 1** Select the input source to be played.
 - 2** Select the input mode and play (surround) mode.
 - 3** Start recording on the tape or video deck.
- ※ For instructions, refer to the component's operating instructions.



- The AUDIO IN's signal selected with **INPUT SELECTOR** are output to the CD-R/TAPE and VCR AUDIO OUT terminals.
- Digital signals are not output to the audio output terminals.

Simultaneous recording

The signals of the source selected with **INPUT SELECTOR** are output simultaneously to the CD-R/TAPE and VCR REC OUT terminals. If a total of two tape and/or video decks are connected and set to the recording mode, the same source can be recorded simultaneously on every decks.

About the memory functions

- Last function memory**
 The various settings set when the AVR-587's power is switched to standby are stored in the memory. When the power is turned back on, the settings made when the power was switched to standby are recalled.
- Backup memory**
 The various settings are stored in the memory for about 1 week, even when the power is turned off or the power cord is unplugged.

Initialization of the microprocessor (Reset)

If the indication on the display is not normal or if the operation of the unit is not correct, then the microprocessor should be reset by the following procedure.

- 1** Switch off the unit using **<POWER>**.
- 2** Keep both **<SPEAKER> (A and B)** depressed and turn on the unit by pressing **<POWER>**.
- 3** Check that the entire display is flashing at 1-second intervals and release the buttons.
 - The microprocessor will be initialized.



- If step 3 does not work, start over from step 1.
- If the microprocessor has been reset, all the button settings are reset to the default values (the values set upon shipment from the factory).

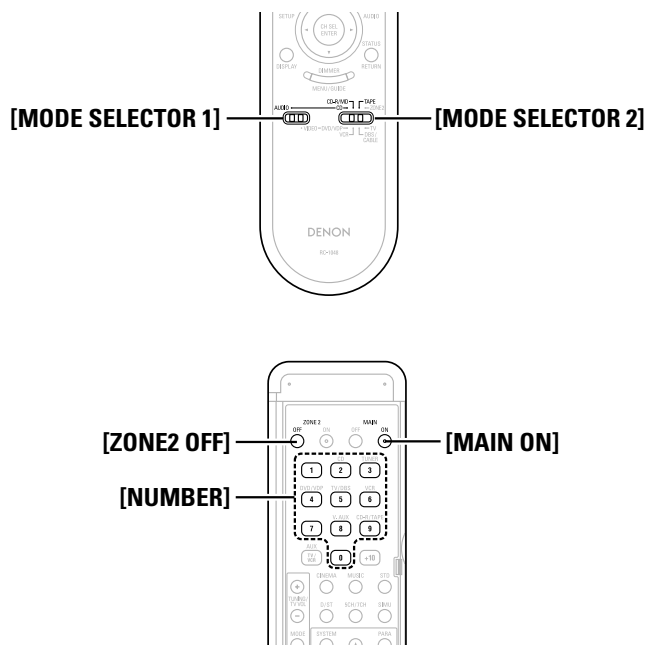

Operating the remote control unit

Operating DENON audio components

- 1** Set **[MODE SELECTOR 1]** to “AUDIO”.
- 2** Set **[MODE SELECTOR 2]** to the position for the component to be operated (CD, CD-R/MD or TAPE).
- 3** Operate the audio component.
 - ※ For details, refer to the component’s operating instructions.
 - ※ While this remote control is compatible with a wide range of infrared controlled components, it may be the case that some component models cannot be operated with this remote control.

Setting the preset memory function

- DENON and other makes of components can be operated by setting the preset memory.
- This remote control unit can be used to operate components of other manufacturers without using the learning function by registering the manufacturer of the component as shown in the list of preset codes (☞ End of this manual).
- Operation is not possible for some models.

- 1** Set **[MODE SELECTOR 1]** to “AUDIO” or “VIDEO”.

※ Set to the AUDIO side for the CD, TAPE or CD-R/MD position, and to the VIDEO side for the DVD/VDP, DBS/CABLE, VCR or TV position.

- 2** Set **[MODE SELECTOR 2]** to the component to be registered.

- 3** Press **[ZONE2 OFF]** and **[MAIN ON]** at the same time.
 - The indicator starts flashing.

- 4** Referring to the included list of preset codes, press **[NUMBER]** to input the preset code (a 3-digit number) for the manufacturer of the component whose signals you want to store in the memory.

- 5** To store the codes of another component in the memory, repeat steps 1 to 4.



- The signals for the pressed buttons are emitted while setting the preset memory. To avoid accidental operation, cover the remote control unit’s transmitting window while setting the preset memory.
- Depending on the model and year of manufacture, this function cannot be used for some models, even if they are of makes listed in the list of preset codes.
- Some manufacturers use more than one type of remote control code. Refer to the included list of preset codes to change the number and verify correct operation.
- The preset memory can be set for one component only among the following: CD-R/MD, DVD/VDP and DBS/CABLE.

Operating the remote control unit

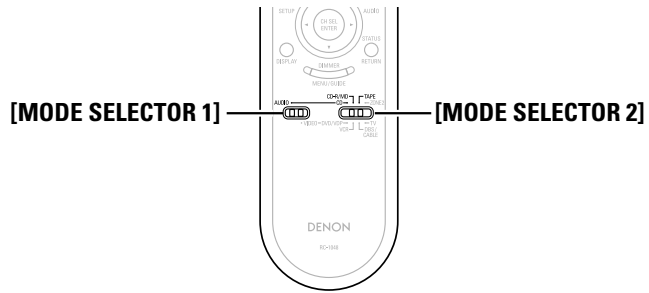

Operating a component stored in the preset memory

1 Set [MODE SELECTOR 1] to "AUDIO" or "VIDEO".

※ Set to the AUDIO side for the CD, TAPE or CD-R/MD position, and to the VIDEO side for the DVD/VDP, DBS/CABLE, VCR or TV position.

2 Set [MODE SELECTOR 2] to the component you want to operate.

3 Operate the component.

※ For details, refer to the component's operating instructions.
 ※ Some models cannot be operated with this remote control unit.

Operating the remote control unit

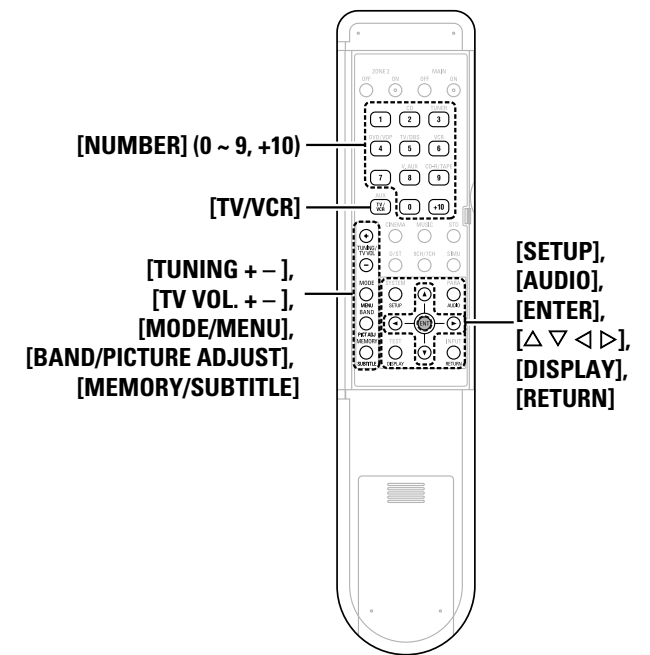
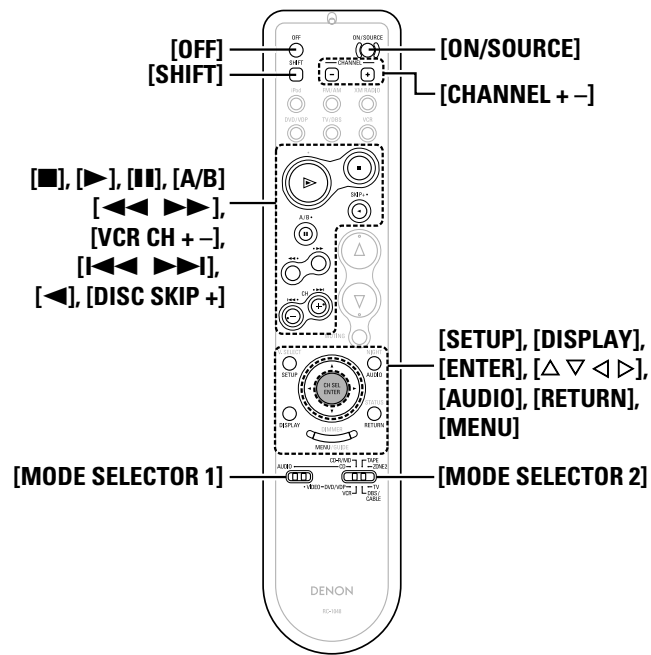

Operating the remote control unit

Operating the remote control unit

□ Functions of buttons for the different devices

[Front]

Device operated	CD player	CD recorder	MD recorder	Tape deck	DVD player	Video disc player	Video deck	Satellite tuner	Cable TV	TV (Monitor)
MODE SELECTOR 1	AUDIO				VIDEO					
MODE SELECTOR 2	CD	CD-R / MD		TAPE	DVD / VDP		VCR	DBS / CABLE		TV
OFF	–	–	–	–	Power off	–	–	–	–	–
ON / SOURCE	–	–	–	–	Power on	Power on /Standby	Power on /Standby	Power on /Standby	Power on /Standby	Power on /Standby
SHIFT	Preset channel selection	Preset channel selection	Preset channel selection	Preset channel selection	–	–	–	–	–	–
CHANNEL –	Preset channel selection	Preset channel selection	Preset channel selection	Preset channel selection	Channels –	Channels –	Channels –	Channels –	Channels –	Channels –
CHANNEL +	Preset channel selection	Preset channel selection	Preset channel selection	Preset channel selection	Channels +	Channels +	Channels +	Channels +	Channels +	Channels +
▶	Play	Play	Play	Forward play	Play	Play	Play	Punch through	Punch through	Punch through
■	Stop	Stop	Stop	Stop	Stop	Stop	Stop			
II, A/B	Pause	Pause	Pause	A/B switching	Pause	Pause	Pause			
◀, DISC SKIP +	Disc skip +	–	–	Reverse play	Disc skip	–	–			
◀◀	Search (reverse)	Search (reverse)	Search (reverse)	Rewind	Search (reverse)	Search (reverse)	Search (reverse)			
▶▶	Search (forward)	Search (forward)	Search (forward)	Fast forward	Search (forward)	Search (forward)	Search (forward)			
I◀◀, VCR CH –	Skip (reverse)	Skip (reverse)	Skip (reverse)	–	Skip (reverse)	Skip (reverse)	Channel –			
▶▶I, VCR CH +	Skip (forward)	Skip (forward)	Skip (forward)	–	Skip (forward)	Skip (forward)	Channel +			
SETUP	–	–	–	–	Setup	–	–	–	–	–
△ ▽ ◀ ▷	–	–	–	–	Cursor operation	–	–	Cursor operation	Cursor operation	Cursor operation
AUDIO	–	–	–	–	Audio	–	–	–	–	–
ENTER	–	–	–	–	Enter	–	–	Enter	Enter	Enter
DISPLAY	–	–	–	–	Display selection	–	–	Display selection	Display selection	Display selection
RETURN	–	–	–	–	Return	–	–	Return	Return	Return
MENU	–	–	–	–	Menu	–	–	Menu	Menu	Menu

Operating the remote control unit

Operating the remote control unit

[Rear]

Device operated	CD player	CD recorder	MD recorder	Tape deck	DVD player	Video disc player	Video deck	Satellite tuner	Cable TV	TV (Monitor)
MODE SELECTOR 1	AUDIO				VIDEO					
MODE SELECTOR 2	CD	CD-R / MD		TAPE	DVD / VDP		VCR	DBS / CABLE		TV
NUMBER (0 ~ 9, +10)	–	–	–	–	Number input / Track selection	Number input / Track selection	–	Channels	Channels	Channels
TV / VCR	–	–	–	–	Input mode selection	Input mode selection	Input mode selection	Input mode selection	Input mode selection	Input mode selection
TUNING + / TV VOL +	Tuning	Tuning	Tuning	Tuning	Volume control +	Volume control +	Volume control +	Volume control +	Volume control +	Volume control +
TUNING – / TV VOL –	Tuning	Tuning	Tuning	Tuning	Volume control –	Volume control –	Volume control –	Volume control –	Volume control –	Volume control –
MODE / MENU	Auto/Manual switching	Auto/Manual switching	Auto/Manual switching	Auto/Manual switching	Menu	–	–	Menu	Menu	Menu
SETUP	–	–	–	–	Setup	–	–	–	–	–
△ ▽ ◀ ▶	–	–	–	–	Cursor operation	–	–	Cursor operation	Cursor operation	Cursor operation
AUDIO	–	–	–	–	Audio	–	–	–	–	–
BAND / PICTURE ADJUST	AM/FM/XM switching	AM/FM/XM switching	AM/FM/XM switching	AM/FM/XM switching	Picture adjust	–	–	–	–	–
ENTER	–	–	–	–	Enter	–	–	Enter	Enter	Enter
MEMORY / SUBTITLE	Preset memory	Preset memory	Preset memory	Preset memory	Subtitle	–	–	–	–	–
DISPLAY	–	–	–	–	Display selection	–	–	Display selection	Display selection	Display selection
RETURN	–	–	–	–	Return	–	–	Return	Return	Return
Default setting (Preset code)	DENON (111)	DENON (111)	–	DENON (111)	DENON (111)	–	HITACHI (108)	–	ABC (007)	HITACHI (134)
Special remarks	①	①		①	①, ②		①	①, ③		①, ③

Special remarks:

- ① It is only possible to set the preset memory for one device per mode. When a new code is preset, the previous code is automatically deleted.
- ② Note that the function names of the DVD buttons on the remote control unit may differ for some brands. Check beforehand.
- ③ The CD, CD-R/MD, TAPE, VCR or DVD/VDP buttons can be assigned to a TV or satellite tuner (or cable TV) (☞ page 48).

Operating the remote control unit

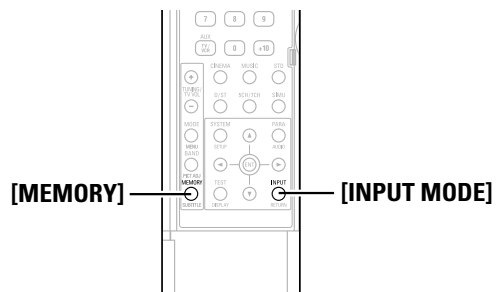
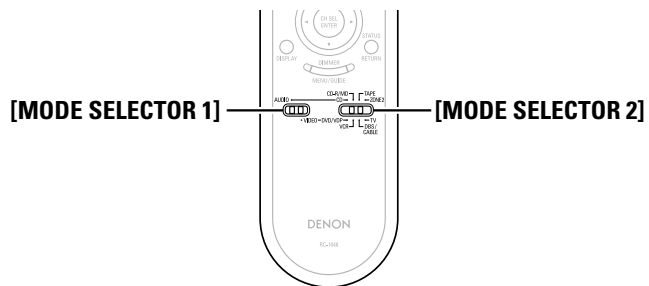

Operating the remote control unit

Setting the punch through function

“Punch Through” is a function allowing you to operate ►, ■, ◀◀, ►►, ◀◀◀ and ►►► on CD, TAPE, CD-R/MD, DVD/VDP or VCR components when in the DBS/CABLE or TV mode. By default, nothing is set.

- 1** Set [MODE SELECTOR 1] to “VIDEO”.
- 2** Set [MODE SELECTOR 2] to the component to be registered (DBS/CABLE or TV).
- 3** Press [MEMORY] and [INPUT MODE] at the same time.
 - The indicator starts flashing.
- 4** Input the number of the component you want to set.

	No.
CD	1
TAPE	2
CD-R/MD	3
DVD/VDP	4
VCR	5
No setting	0

Additional Information

About the speakers

Surround back speakers

Sound position directly to the rear can be achieved easily by adding a surround back speaker to a 5.1-channel system. In addition, the acoustic image extending between the sides and the rear is narrowed, thus greatly improving the expression of the surround signals for sounds moving from the sides to the back and from the front to the point directly behind the listening position.

Change of positioning and acoustic image with 5.1-channel systems

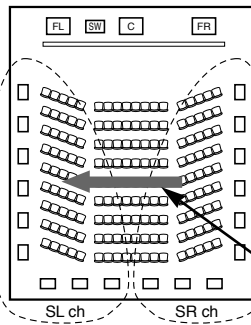

Movement of acoustic image from SR to SL

Change of positioning and acoustic image with 6.1-channel systems

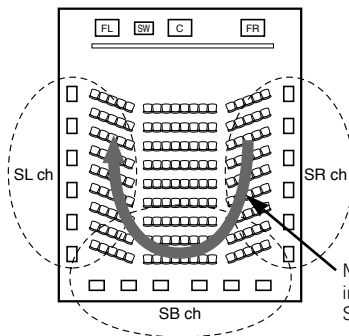

Movement of acoustic image from SR to SB to SL

In addition to sources recorded in 6.1-channels, the surround effect of conventional 2- to 5.1-channel sources can also be enhanced.

Number of surround back speakers

We recommend using two speakers. When using dipolar speakers in particular, be sure to use two speakers.

Placement of the surround left and right channels when using surround back speakers

We recommend installing the speakers for the surround "L" and "R" channels a bit forward.

Examples of speaker layouts

Below we introduce examples of speaker layouts. Refer to these to arrange your speakers according to their type and how you want to use them.

[1] Using surround back speaker(s)

① When mainly playing movies

Recommended when your surround speakers are single or 2-way speakers.

[As seen from above]

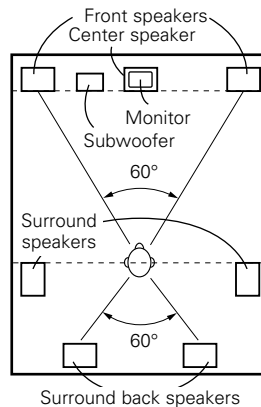

[As seen from the side]

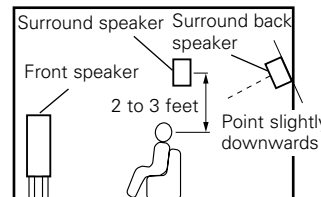

② When playing movies and musics

[As seen from above]

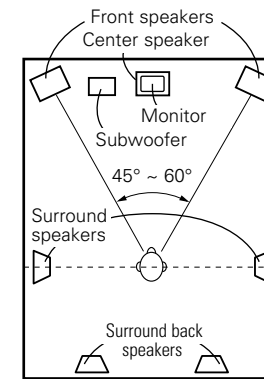

[As seen from the side]

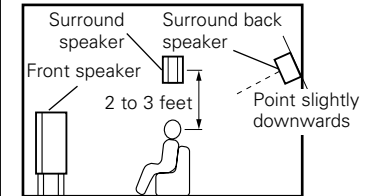

[2] When not using surround back speakers

[As seen from above]

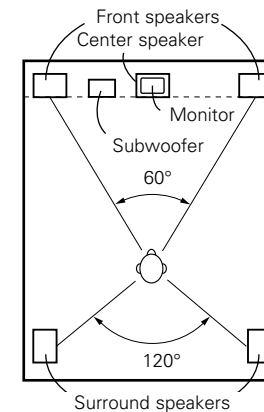

[As seen from the side]

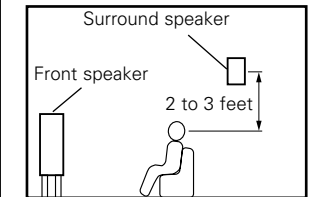

Additional Information

Surround

The AVR-587 is equipped with a digital signal processing circuit that lets you play program sources in the surround mode to achieve the same sense of presence as in a movie theater.

Dolby Surround**[1] Dolby Digital**

Dolby Digital is the multi-channel digital signal format developed by Dolby Laboratories.

A total of 5.1-channels are played: three front channels ("FL", "FR" and "C"), two surround channels ("SL" and "SR") and the "LFE" channel for low frequencies.

Because of this, there is no crosstalk between channels and a realistic sound field with a "three-dimensional" feeling (sense of distance, movement and positioning) is achieved.

A real, overpowering sense of presence is achieved when playing movie sources in AV rooms as well.

[2] Dolby Pro Logic II

Dolby Pro Logic II is a matrix decoding technology developed by Dolby Laboratories. Regular music such as that on CDs is encoded into 5 channels to achieve an excellent surround effect.

The surround channel signals are converted into stereo and full band signals (with a frequency response of 20 Hz to 20 kHz or greater) to create a "three-dimensional" sound image offering a rich sense of presence for all stereo sources.

[3] Dolby Pro Logic IIx

Dolby Pro Logic IIx is a further improved version of the Dolby Pro Logic II matrix decoding technology.

Audio signals recorded in 2 channels are decoded to achieve a natural sound with up to 7.1-channels.

There are three modes: "Music" suited for playing music, "Cinema" suited for playing movies, and "Game" which is optimum for playing games.

Sources recorded in Dolby Surround

Sources recorded in Dolby Surround are indicated with the following logo marks.

Dolby Surround support mark: 

Manufactured under license from Dolby Laboratories. "Dolby", "Pro Logic" and the double-D symbol are trademarks of Dolby Laboratories.

DTS Digital Surround

DTS Digital Surround is a digital surround format developed by Digital Theater Systems of the United States.

The number of playback channels and the playing band is the same as for Dolby Digital (5.1-channels).

The compression rate of the audio data when it was recorded on the medium is lower than for Dolby Digital, so there is more information when the data is decoded, resulting in richer, clearer sound quality.

MANUFACTURED UNDER LICENSE FROM DIGITAL THEATER SYSTEMS, INC.

U.S. PAT. NO'S. 5,451,942; 5,956,674; 5,974,380; 5,978,762; 6,226,616; 6,487,535 AND OTHER U.S. AND WORLD-WIDE PATENTS ISSUED AND PENDING.

"DTS", "DTS-ES", "Neo:6", AND "DTS 96/24" ARE TRADEMARKS OF DIGITAL THEATER SYSTEMS, INC. © 1996, 2003 DIGITAL THEATER SYSTEMS, INC. ALL RIGHTS RESERVED.

DTS-ES™

DTS-ES is a new surround format developed by Digital Theater Systems.

A sound image and sense of positioning can be achieved by adding a surround back ("SB") channel to the conventional 5.1-channels.

DTS-ES™ Discrete 6.1:

This is the latest format, in which all 6.1-channels, including the "SB" channel, are recorded independently. Since the different channels are independent, the sound can be designed with total freedom.

DTS-ES™ Matrix 6.1:

With this format, the "SB" channel is matrix-encoded and inserted into the "SL" and "SR" channels, then decoded for the "SL", "SR" and "SB" channels upon playback. This achieves a surround sound more faithful to the artist's sound design intentions than with conventional 5.1- or 6.1-channel systems.

DTS 96/24

DTS 96/24 is a multi-channel digital signal format developed by Digital Theater Systems.

The sampling frequency is raised to achieve 5.1-channel playback with high quality sound (sampling frequency: 96 kHz, quantization: 24 bits).

Additional Information

DTS NEO:6 surround

This is a matrix decoding technology for 6.1-channel surround playback of 2-channel sources.

The optimum decoding for the type of signal source to be played can be selected. There are two modes.

DTS NEO:6 CINEMA:

This mode is suited for playing movies. It achieves the same type of sound as in a movie theater, even with 2 channels.

DTS NEO:6 MUSIC:

This mode is suited for playing music. A natural sense of expansion is added to the sound field.

Neural Surround

Neural Surround™, a breakthrough in audio technology, will bring the excitement of surround music to more of America's listening audience. It provides the rich envelopment and discrete image detail of surround sound in a format 100 % compatible with stereo. With superior spectral resolution and channel separation, Neural Surround™ draws the brain's attention to sonic details in musical instruments, vocals, and ambience that are typically masked by other playback systems. This allows the listener to fully experience the richness and subtleties in recorded performance as never before. As the chosen format for XM Satellite Radio's new XM HD surround programming, Neural Surround will help deliver more surround music to more listeners than any other broadcast format. XM Satellite Radio will be the first radio company -to broadcast surround sound on the radio 24 hours a day and will offer three channels fully dedicated to Neural Surround™ music. This alone will amount to more than 25,000 hours of Neural Surround™ music each year.



- This product is manufactured under license from Neural Audio Corporation.

D&M Holdings Inc. hereby grants the user a non-exclusive, non-transferable, limited license right exercisable to use the NA SURROUND Technology and other US and World Wide Patents Pending technology.

"Neural" and "Neural Audio" and "Neural Surround" Are trademarks of Neural Audio Corporation. All Rights Reserved.

Troubleshooting

If a problem should arise, first check the following.

1. Are the connections correct?
2. Have you operated the receiver according to the Operating Instructions?
3. Are the speakers and other components operating properly?

If this unit is not operating properly, check the items listed in the table below. Should the problem persist, there may be a malfunction. Disconnect the power immediately and contact your store of purchase.

Symptom	Cause	Measures	Page
Display not lit and sound not produced when POWER switch set to on.	<ul style="list-style-type: none"> Power supply cord not plugged in securely. 	<ul style="list-style-type: none"> Check the insertion of the power supply cord plug. 	15
Display lit but sound not produced.	<ul style="list-style-type: none"> Speaker cables not securely connected. INPUT SELECTOR knob position is not appropriate. Volume control set to minimum. MUTING is on. No digital signal is being input. 	<ul style="list-style-type: none"> Connect securely. 	7
		<ul style="list-style-type: none"> Switch to the proper position. 	25
		<ul style="list-style-type: none"> Turn volume up to suitable level. 	25
		<ul style="list-style-type: none"> Switch off MUTING. Properly select a digital signal input source. 	26 21
Nothing is displayed on monitor.	<ul style="list-style-type: none"> AVR-587's video output terminals and monitor's input terminals are not properly connected. Monitor's input setting is wrong. 	<ul style="list-style-type: none"> Check that the connections are correct. 	8, 10 ~ 15
		<ul style="list-style-type: none"> Set the monitor's input selector to the terminals to which video signals are connected. 	—
No DTS sound is produced.	<ul style="list-style-type: none"> DVD player's audio output setting is not set to bit stream. DVD player is not DTS-compatible. AVR-587's input setting is set to analog. 	<ul style="list-style-type: none"> Make the DVD player's default settings. 	—
		<ul style="list-style-type: none"> Use a DTS-compatible player. 	—
		<ul style="list-style-type: none"> Set to "AUTO" or "DTS". 	25
Copying from DVD to VCR is not possible.	<ul style="list-style-type: none"> Copying between a source such as DVD and a VCR is not usually possible, as DVDs are often encoded with copy-protection signals that prevent VCR recording. 	<ul style="list-style-type: none"> Copying is not possible. 	—
No sound is produced from subwoofer.	<ul style="list-style-type: none"> Subwoofer's power is not on. Subwoofer's initial setting is set to "NO". Subwoofer's output is not connected. The subwoofer's channel volume level is set to "OFF". 	<ul style="list-style-type: none"> Turn on the power. Set the setting to "YES". 	— 19
		<ul style="list-style-type: none"> Connect properly. 	7
		<ul style="list-style-type: none"> Turn the subwoofer's channel volume level up. 	36

Symptom	Cause	Measures	Page
No test tones are produced.	<ul style="list-style-type: none"> Surround mode is set to a mode other than STANDARD (Dolby/DTS Surround). 	<ul style="list-style-type: none"> Set to STANDARD (Dolby/DTS Surround). 	—
No sound is produced from surround speakers.	<ul style="list-style-type: none"> Surround mode is set to "STEREO". 	<ul style="list-style-type: none"> Set to a mode other than "STEREO". 	—
This unit does not operate properly when remote control unit is used.	<ul style="list-style-type: none"> Batteries dead. Remote control unit too far from this unit. Obstacle between this unit and remote control unit. Different button is being pressed. ⊕ and ⊖ ends of batteries inserted in reverse. 	<ul style="list-style-type: none"> Replace with new batteries. Move closer. 	3 3
		<ul style="list-style-type: none"> Remove obstacle. 	3
		<ul style="list-style-type: none"> Press the proper button. 	—
		<ul style="list-style-type: none"> Insert batteries properly. 	3
Power has turned off and the power indicator is blinking red.	<ul style="list-style-type: none"> The set's internal temperature has risen and the protection circuit has been activated. The core wires of the speaker cables are touching each other or the AVR-587's rear panel, activating the protection circuit. AVR-587 is malfunctioning. 	<ul style="list-style-type: none"> Put the AVR-587 in a well-ventilated place. 	7
		<ul style="list-style-type: none"> Turn off the power, then wait for the set to fully cool off before turning the power back on. 	7
		<ul style="list-style-type: none"> Check the connections of all the speaker cables. 	7
		<ul style="list-style-type: none"> Turn off the power and contact a DENON customer service center. 	7
Sound is only produced from the center speaker.	<ul style="list-style-type: none"> You are playing a monaural source (TV, AM radio broadcast, etc.) in the STANDARD (Dolby/DTS Surround) mode. 	<ul style="list-style-type: none"> When playing monaural sources, select a surround mode other than STANDARD (Dolby/DTS Surround) mode. 	35
"DOLBY DIGITAL" is not displayed.	<ul style="list-style-type: none"> DVD player's digital audio output setting is not proper. 	<ul style="list-style-type: none"> Check the DVD player's audio output setting. For details, see the DVD player's operating instructions. 	—
"CHECK ANTENNA" is displayed in the XM mode.	<ul style="list-style-type: none"> AVR-587's XM connectors and the XM Passport System is not properly connected. 	<ul style="list-style-type: none"> Check that the connection are correct. 	38
"NO SIGNAL" is displayed in the XM mode.	<ul style="list-style-type: none"> The signal cannot be received. 	<ul style="list-style-type: none"> Reposition your XM Passport System. 	38
"OFF AIR" is displayed in the XM mode.	<ul style="list-style-type: none"> The selected channel is not currently broadcasting. 	<ul style="list-style-type: none"> Select the another channel. 	38
Receiving only XM channels 0 and 1.	<ul style="list-style-type: none"> The XM Tuner is not activated. 	<ul style="list-style-type: none"> Contact XM Radio. 	38

Specifications

□ Audio section

• Power amplifier

Rated output:

Front (A, B):
 75 W + 75 W (8 Ω/ohms, 20 Hz ~ 20 kHz with 0.08 % T.H.D.)
 110 W + 110 W (6 Ω/ohms, 1 kHz with 0.7 % T.H.D.)

Center:

75 W (8 Ω/ohms, 20 Hz ~ 20 kHz with 0.08 % T.H.D.)
 110 W (6 Ω/ohms, 1 kHz with 0.7 % T.H.D.)

Surround:

75 W + 75 W (8 Ω/ohms, 20 Hz ~ 20 kHz with 0.08 % T.H.D.)
 110 W + 110 W (6 Ω/ohms, 1 kHz with 0.7 % T.H.D.)

Surround Back:

75 W + 75 W (8 Ω/ohms, 20 Hz ~ 20 kHz with 0.08 % T.H.D.)
 110 W + 110 W (6 Ω/ohms, 1 kHz with 0.7 % T.H.D.)

Output terminals:

Front: A or B 6 ~ 16 Ω/ohms
 A + B 12 ~ 16 Ω/ohms
 Center, Surround, Surr. Back 6 ~ 16 Ω/ohms

• Analog

Input sensitivity / input impedance:

200 mV / 47 kΩ/kohms

Frequency response:

10 Hz ~ 100 kHz: +1, -3 dB (DIRECT mode)

S/N:

98 dB (DIRECT mode)

□ Video section

• Standard video terminals

Input / output level and impedance:

1 Vp-p, 75 Ω/ohms

Frequency response:

5 Hz ~ 10 MHz — +1, -3 dB

• S-Video terminals

Input / output level and impedance:

Y (brightness) signal — 1 Vp-p, 75 Ω/ohms

C (color) signal — 0.286 Vp-p, 75 Ω/ohms

5 Hz ~ 10 MHz — +1, -3 dB

Frequency response:

• Color component video terminal

Input / output level and impedance:

Y (brightness) signal — 1 Vp-p, 75 Ω/ohms

P_B/C_B signal — 0.7 Vp-p, 75 Ω/ohms

P_R/C_R signal — 0.7 Vp-p, 75 Ω/ohms

Frequency response:

5 Hz ~ 30 MHz — +0, -3 dB

□ Tuner section

[FM]

[AM]

(note: μV at 75 Ω/ohms, 0 dBf = 1 x 10⁻¹⁶ W)

Receiving Range:

87.5 MHz ~ 107.9 MHz

520 kHz ~ 1710 kHz

Usable Sensitivity:

1.0 μV (11.2 dBf)

18 μV

50 dB Quieting Sensitivity:

MONO 1.6 μV (15.3 dBf)

STEREO 23 μV (38.5 dBf)

S/N (IHF-A):

MONO 77 dB

STEREO 72 dB

Total Harmonic Distortion (at 1 kHz):

MONO 0.15%

STEREO 0.3%

□ General

Power supply:

AC 120 V, 60 Hz

Power consumption:

4.3 A

1 W Max (Standby)

Maximum external dimensions:

434 (W) x 147 (H) x 417 (D) mm (17-3/32" x 5-25/32" x 16-27/64")

Mass:

11.2 kg (24 lbs 11 oz)

□ Remote control unit (RC-1048)

Batteries:

R6P/AA Type (Two batteries)

External dimensions:

52 (W) x 243 (H) x 21 (D) mm (2-3/64" x 9-9/16" x 53/64")

Mass:

175 g (Approx. 6.2 oz) (included batteries)

* For purposes of improvement, specifications and design are subject to change without notice.

☐ List of preset codes

DVD

Denon	014, *[111]
Aiwa	009
Hitachi	010
JVC	006, 011
Konka	012, 013
Magnavox	005
Mitsubishi	004
Panasonic	014
Philips	005, 015, 016, 017
Pioneer	003, 008
Sanyo	018
Sony	002, 019, 020
Toshiba	001, 021, 022
Zenith	023

VDP

Denon	028, 029, 112
Magnavox	026
Mitsubishi	028
Panasonic	029, 030
Philips	026
Pioneer	028, 031
RCA	032
Sony	033, 034, 035, 036

VCR

Admiral	081
Aiko	095
Aiwa	009
Akai	026, 027, 070, 072, 082, 083, 084
Alba	055
Amstrad	009

ASA	042
Asha	087
Audio Dynamic	005, 085
Audiovox	088
Beaumarck	087
Broksonic	086, 093
Calix	088
Candle	006, 087, 088, 089, 090
Canon	049, 057
Capehart	025, 055, 056, 071
Carver	015
CCE	095
Citizen	006, 007, 087, 088, 089, 090, 095
Craig	007, 087, 088, 091, 115
Curtis Mathes	006, 049, 073, 080, 087, 090, 092
Cybernex	087
Daewoo	025, 055, 059, 074, 089, 093, 095, 096
Daytron	025, 055
DBX	005, 085
Dumont	053
Dynatech	009
Electrohome	001, 088, 097
Electroponic	088
Emerson	001, 009, 017, 027, 086, 088, 089, 092, 093, 097, 100, 101, 102, 103, 104, 117
Fisher	009, 028, 031, 053, 054, 091, 099, 115
GE	007, 011, 049, 050, 051, 052, 073, 080, 087

Go Video	047, 048
Goldstar	000, 006, 012, 062, 088
Gradiente	094
Grundig	042
Harley Davidson	094
Harman Kardon	040, 062
Hi-Q	091
Hitachi	009, 013, 023, 026, 058, *[108], 109, 110, 111
JC Penny	004, 005, 007, 023, 028, 049, 062, 085, 087, 088
Jensen	013, 026
JVC	004, 005, 006, 026, 029, 043, 044, 045, 046, 085
Kenwood	004, 005, 006, 026, 029, 033, 045, 085, 090
Kodak	088
Lloyd	009, 094
LXI	088
Magnavox	015, 016, 042, 049, 063, 106
Magnin	087
Marantz	004, 005, 006, 015, 042, 049, 085, 090
Marta	088
MEI	049
Memorex	009, 033, 049, 053, 060, 081, 087, 088, 091, 094, 115
Metz	123, 124, 125, 126, 127, 128
MGA	001, 017, 027, 041, 097
MGN Technology	087
Midland	011

Minolta	013, 023
Mitsubishi	001, 003, 008, 013, 014, 017, 027, 029, 039, 040, 041, 045, 097
Motorola	081
Montgomery Ward	001, 002, 007, 009, 049, 063, 081, 115, 117
MTC	009, 087, 094
Multitech	007, 009, 011, 087, 090, 094
NAD	038
NEC	004, 005, 006, 018, 026, 029, 045, 061, 062, 085
Nikko	088
Noblex	087
Optimus	081, 088
Optonica	021
Panasonic	024, 049, 064, 066, 067, 068, 069, 107
Perdio	009
Pentax	009, 013, 023, 058, 090
Philco	015, 016, 049
Philips	015, 021, 042, 049, 105
Pilot	088
Pioneer	005, 013, 029, 036, 037, 038, 045, 085
Portland	025, 055, 090
Proscan	063, 080
Pulsar	060
Quartz	033
Quasar	034, 035, 049
Radio Shack	001, 002, 021, 081, 087, 088, 091, 094, 097, 098, 115

Radix	088	Technics	024, 049	Bell & Howell	045, 118	Fujitsu	004, 062
Randex	088	Teknika	009, 010, 022, 049, 088, 094	Bradford	061	Funai	004, 062
RCA	007, 013, 019, 023, 058, 063, 064, 065, 073, 080, 082, 087	TMK	087, 092	Brockwood	003, 047	Futuretech	004
Realistic	009, 021, 031, 033, 049, 053, 081, 087, 088, 091, 094, 097, 098	Toshiba	013, 017, 020, 041, 059, 089, 098, 099, 117	Candle	003, 030, 031, 032, 038, 047, 049, 050, 122	GE	020, 036, 037, 040, 044, 058, 066, 088, 119, 120, 125, 147
Ricoh	055	Totevision	007, 087, 088	Capehart	003	Goldstar	000, 015, 029, 031, 039, 048, 051, 056, 057, 067, 068, 069, 116
Salora	033, 041	Unirech	087	Celebrity	046	Grundig	062
Samsung	007, 011, 051, 059, 070, 083, 087, 089, 113	Vectror Research	005, 062, 085, 089, 090	Circuit City	003	Hitachi	029, 031, 051, 052, 070, 111, 112, 113, 124, *[134]
Sanky	081	Victor	005, 045, 046, 085	Citizen	029, 030, 031, 032, 034, 038, 047, 049, 050, 054, 061, 095, 122, 123	Hitachi Pay TV	151
Sansui	005, 026, 029, 045, 061, 085, 114	Video Concepts	005, 027, 085, 089, 090	Concerto	031, 047, 049	Infinity	017, 071
Sanyo	032, 033, 053, 087, 091, 115, 116	Videosonic	007, 087	Colortyme	003, 047, 049, 135	Janeil	122
SBR	042	Wards	013, 021, 023, 087, 088, 089, 091, 094, 097, 118, 119, 120	Contec	013, 051, 052, 061	JBL	017, 071
Scott	017, 020, 086, 089, 093, 117	XR-1000	094	Cony	051, 052, 061	JC Penny	020, 034, 039, 040, 041, 044, 048, 050, 058, 066, 069, 076, 088, 090, 095, 125, 136, 159
Sears	013, 023, 028, 031, 033, 053, 054, 088, 091, 098, 099, 115	Yamaha	004, 005, 006, 026, 062, 085	Craig	004, 061	JCB	046
Sentra	055	Zenith	060, 078, 079	Crown	029	JVC	019, 051, 052, 072, 073, 091, 117, 126
Sharp	001, 002, 021, 097	TV		Curtis Mathes	029, 034, 038, 044, 047, 049, 053, 095, 118	Kawasho	018, 046
Shogun	087	Admiral	045, 121	Daewoo	027, 029, 039, 048, 049, 054, 055, 106, 107, 137	Kenwood	038, 056, 057
Sony	075, 076, 077, 078, 079, 121, 122	Adventura	122	Daytron	003, 049	Kloss	010, 032
STS	023	Aiko	054	Dimensia	044	Kloss Novabeam	005, 122, 127, 131
Sylvania	009, 015, 016, 017, 041, 049, 094	Akai	016, 027, 046	Dixi	007, 015, 027	KTV	074, 123
Symphonic	009, 094	Alleron	062	Electroband	046	Loewe	071
Tandy	009	A-Mark	007	Electrohome	029, 056, 057, 058, 147	Logik	144
Tashiko	009, 088	Amtron	061	Elta	027	Luxman	031
Tatung	004, 026, 030	Anam	006, 007, 036	Emerson	029, 051, 059, 060, 061, 062, 118, 123, 124, 139, 148	LXI	008, 014, 017, 024, 040, 044, 063, 071, 075, 076, 077, 118, 125
Teac	004, 009, 026, 094	Anam National	061, 147	Envision	038		
		AOC	003, 007, 033, 038, 039, 047, 048, 049, 133	Etron	027		
		Archer	007	Fisher	014, 021, 063, 064, 065, 118		
		Audiovox	007, 061	Formenti	155		
		Bauer	155	Fortress	012		
		Belcor	047				

Magnavox	005, 010, 017, 030, 033, 038, 050, 056, 071, 078, 079, 085, 089, 108, 109, 110, 127, 131, 132, 145
Marantz	015, 017, 071, 080
Matsui	027
Memorex	014, 027, 045, 083, 118, 144
Metz	160, 161, 162, 163
MGA	001, 039, 048, 056, 057, 058, 065, 081, 083
Midland	125
Minutz	066
Mitsubishi	001, 016, 039, 048, 056, 057, 058, 065, 081, 082, 083, 105
Montgomery Ward	011, 020, 144, 145, 146
Motorola	121, 147
MTC	031, 034, 039, 048, 095
NAD	008, 075, 076, 128
National	002, 036, 061, 147
National Quenties	002
NEC	031, 038, 039, 048, 057, 084, 086, 135, 147
Nikko	054
NTC	054
Optimus	128
Optonica	011, 012, 093, 121
Orion	004, 139
Panasonic	002, 009, 017, 036, 037, 071, 141, 143, 147
Philco	005, 010, 030, 050, 051, 056, 079, 085, 127, 131, 132, 145, 147

Philips	005, 015, 017, 050, 051, 056, 078, 087, 088, 089, 131, 132, 147
Pioneer	124, 128, 142
Portland	054
Price Club	095
Proscan	040, 044, 125
Proton	035, 051, 092, 129
Pulsar	042
Quasar	036, 037, 074, 141
Radio Shack	011, 044, 063, 093, 118
RCA	040, 044, 125, 130, 137, 151, 152
Realistic	014, 063, 093, 118
Saisho	027
Samsung	003, 015, 034, 053, 055, 057, 094, 095, 136, 153
Sansui	139
Sanyo	013, 014, 021, 022, 063, 064, 081, 096
SBR	015
Schneider	015
Scott	062
Sears	008, 014, 021, 022, 023, 024, 025, 040, 052, 057, 062, 063, 064, 065, 073, 075, 076, 097, 098, 125, 159
Sharp	011, 012, 013, 026, 093, 099, 100, 104, 121
Siemens	013
Signature	045, 144
Simpson	050
Sony	043, 046, 138, 146, 150
Soundesign	030, 050, 062
Spectricon	007, 033

Squareview	004
Supre-Macy	032, 122
Supreme	046
Sylvania	005, 010, 017, 030, 078, 079, 085, 089, 101, 127, 131, 132, 145, 155
Symphonic	004, 148
Tandy	012, 121
Tatung	036, 124
Technics	037
Teknika	001, 030, 032, 034, 052, 054, 078, 083, 095, 144, 156, 157
Tera	035, 129
THOMSON	165, 166
Toshiba	008, 014, 034, 063, 075, 076, 095, 097, 136, 158, 159
Universal	020, 066, 088
Victor	019, 073, 126
Video Concepts	016
Viking	032, 122
Wards	005, 045, 066, 078, 085, 088, 089, 093, 102, 103, 131, 132, 148
Zenith	042, 114, 115, 140, 144, 149
Zonda	007

CABLE

ABC	006, *[007], 008, 009
Archer	010, 011
Century	011
Citizen	011
Colour Voice	012, 013
Comtronic	014

Eastern	015
Garrard	011
Gemini	030, 033, 034
General Instrument	030, 031, 032
Hytex	006
Jasco	011
Jerrold	009, 016, 017, 026, 032
Magnavox	018
Movie Time	019
NSC	019
Oak	000, 006, 020
Panasonic	001, 005
Philips	011, 012, 013, 018, 021
Pioneer	002, 003, 022
RCA	029
Regency	015
Samsung	014, 023
Scientific Atlanta	004, 024, 025
Signal	014
SL Marx	014
Starcom	009
Stargate	014
Teleview	014
Tocom	007, 016
TV86	019
Unika	011
United Artists	006
Universal	010, 011
Viewstar	018, 019
Zenith	027, 028

DBS (SATELLITE)

Alphastar	054
Chaparral	035, 036
Dishnet	053
Drake	037, 038

Echostar Dish	062, 066
GE	048, 055, 056
General Instruments	039, 040, 041
Grundig	070, 071, 072, 073
Hitachi	058, 059
Hughes Network	063, 064, 065, 069
JVC	057
Kathrein	074, 075, 076, 083
Magnavox	060
Nokia	070, 080, 084, 085, 086
Philips	060
Primestar	051
Proscan	048, 055, 056
RCA	048, 055, 056, 068
Realistic	042
Sierra I	036
Sierra II	036
Sierra III	036
Sony	049, 067
STS1	043
STS2	044
STS3	045
SRS4	046
Technisat	077, 078, 079, 081, 082
Toshiba	047, 050
Uniden	061

CD

Denon	*[111], 044
Aiwa	001, 035, 043
Burmster	002
Carver	003, 035
Emerson	004, 005, 006, 007
Fisher	003, 008, 009, 010
JVC	018, 019
Kenwood	011, 012, 013, 014, 017

Magnavox	006, 015, 035
Marantz	016, 028, 035
MCS	016, 024
Onkyo	025, 027
Optimus	017, 020, 021, 022, 023
Philips	014, 032, 033, 035
Pioneer	006, 022, 030
Sears	006
Sony	023, 031
Teac	002, 009, 028
Technics	016, 029, 036
Wards	035, 037
Yamaha	038, 039, 040, 041
Zenith	042

CDR

Denon	*[111], 112
Philips	112

MD

Denon	113
Kenwood	003, 004
Onkyo	007
Sharp	005
Sony	006

TAPE

Denon	*[111]
Aiwa	001, 002
Carver	002
Harman/Kardon	002, 003
JVC	004, 005
Kenwood	006
Magnavox	002
Marantz	002
Onkyo	016, 018

Optimus	007, 008
Panasonic	012
Philips	002
Pioneer	007, 008, 009
Sony	013, 014, 015
Technics	012
Victor	004
Wards	007
Yamaha	010, 011

*[] : Preset codes set upon shipment from the factory.

DVD preset codes			
	111 (default)	014	
DENON Model No.	DVD-555	DVD-2900	DVD-800
	DVD-755	DVD-2910	DVD-1600
	DVD-900	DVD-3800	DVD-2000
	DVD-910	DVD-3910	DVD-2500
	DVD-955	DVD-5900	DVD-3000
	DVD-1000	DVD-5910	DVD-3300
	DVD-1200	DVD-9000	
	DVD-1500	DVM-715	
	DVD-1710	DVM-1800	
	DVD-1910	DVM-1805	
	DVD-2200	DVM-1815	
DVD-2800	DVM-2815		
DVD-2800II	DVM-4800		

DENON

TOKYO, JAPAN
www.denon.com

Denon Brand Company, D&M Holdings Inc.
Printed in China 00D 511 4506 000

Free Manuals Download Website

<http://myh66.com>

<http://usermanuals.us>

<http://www.somanuals.com>

<http://www.4manuals.cc>

<http://www.manual-lib.com>

<http://www.404manual.com>

<http://www.luxmanual.com>

<http://aubethermostatmanual.com>

Golf course search by state

<http://golfingnear.com>

Email search by domain

<http://emailbydomain.com>

Auto manuals search

<http://auto.somanuals.com>

TV manuals search

<http://tv.somanuals.com>