

DENSO R5 Starter Installation Guide For:

- 2002 Freightliner Columbia
- Detroit Diesel Series 60 Engine



This guide will assist the technician with the installation of the R5 starter on this particular application.

These installation procedures may vary based on the engine and make, model & year of the vehicle.

Prior to component replacement carefully troubleshoot the starting circuit to identify the true cause of failure.

All replaced cables or wiring should match original (OEM) specifications AND when reinstalling bolts and hardware, torque to original specifications.

Starter Preparation

Read all installation instructions & service information carefully before installing the R5 starter.

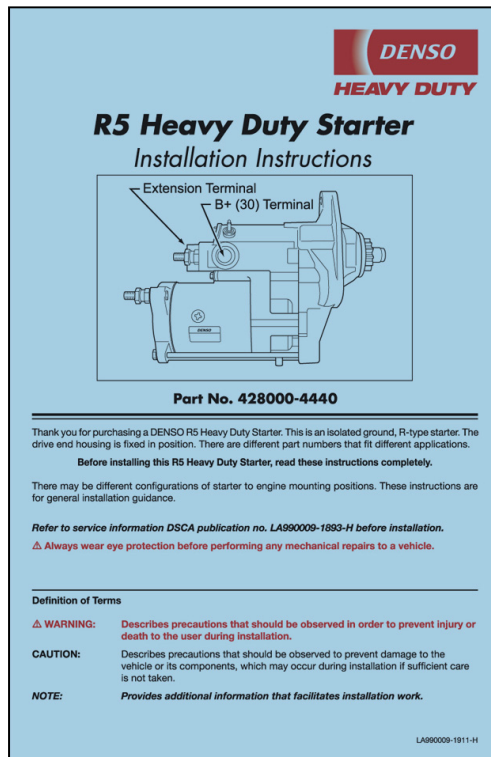

DENSO
HEAVY DUTY

R5 Heavy Duty Starter Installation Instructions

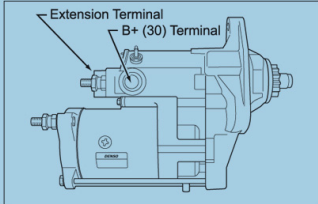

Part No. 428000-4440

Thank you for purchasing a DENSO R5 Heavy Duty Starter. This is an isolated ground, R-type starter. The drive end housing is fixed in position. There are different part numbers that fit different applications.

Before installing this R5 Heavy Duty Starter, read these instructions completely.

There may be different configurations of starter to engine mounting positions. These instructions are for general installation guidance.

Refer to service information DSCA publication no. LA990009-1893-H before installation.

△ Always wear eye protection before performing any mechanical repairs to a vehicle.

Definition of Terms

△ **WARNING:** Describes precautions that should be observed in order to prevent injury or death to the user during installation.

CAUTION: Describes precautions that should be observed to prevent damage to the vehicle or its components, which may occur during installation if sufficient care is not taken.

NOTE: Provides additional information that facilitates installation work.

LA990009-1891-41

Installation Instructions

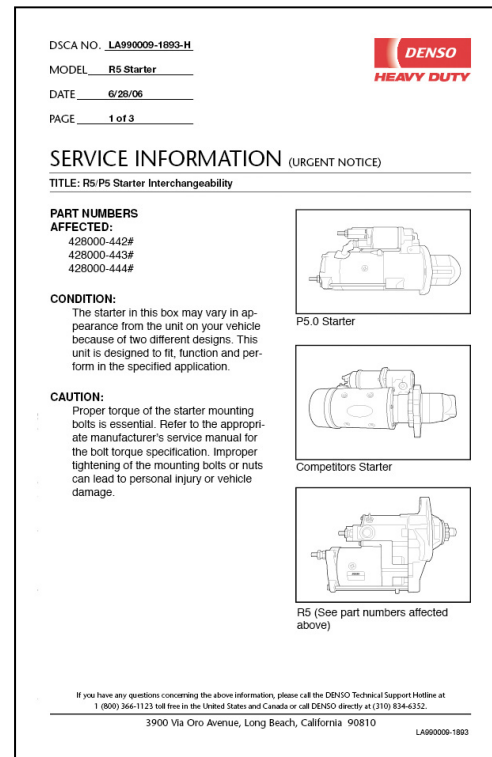

DSCA NO. LA990009-1893-H

MODEL R5 Starter

DATE 6/28/06

PAGE 1 of 3

DENSO
HEAVY DUTY

SERVICE INFORMATION (URGENT NOTICE)

TITLE: R5/P5 Starter Interchangeability

PART NUMBERS AFFECTED:
428000-442#
428000-443#
428000-444#

CONDITION:
The starter in this box may vary in appearance from the unit on your vehicle because of two different designs. This unit is designed to fit, function and perform in the specified application.

CAUTION:
Proper torque of the starter mounting bolts is essential. Refer to the appropriate manufacturer's service manual for the bolt torque specification. Improper tightening of the mounting bolts or nuts can lead to personal injury or vehicle damage.

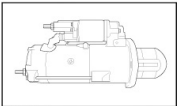

P5.0 Starter

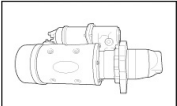

Competitors Starter

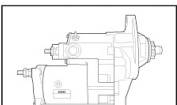

R5 (See part numbers affected above)

If you have any questions concerning the above information, please call the DENSO Technical Support Hotline at 1 (800) 366-1123 toll free in the United States and Canada or call DENSO directly at (310) 834-6352.

3900 Via Oro Avenue, Long Beach, California 90810

LA990009-1893

Service Information

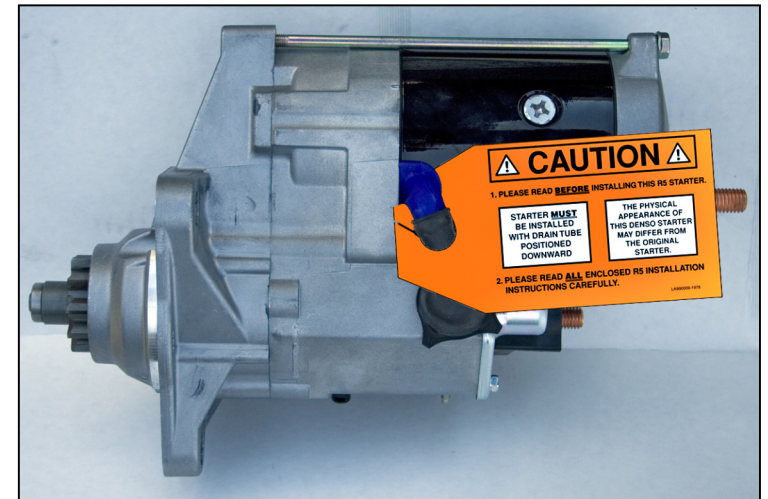

Caution Tag

These items are included with the starter.

Starter Preparation

Confirm the correct part number for the particular application.

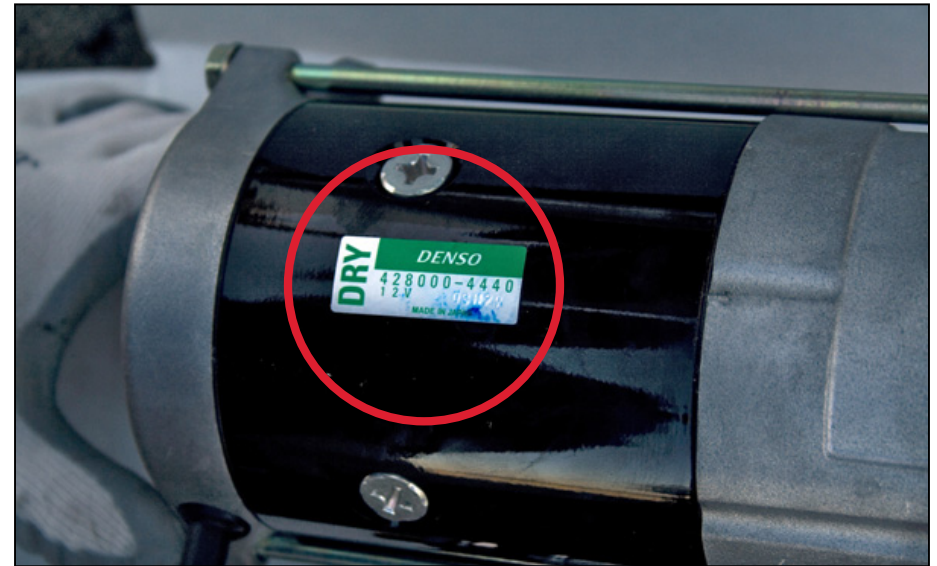

Visually inspect starter at these critical points.

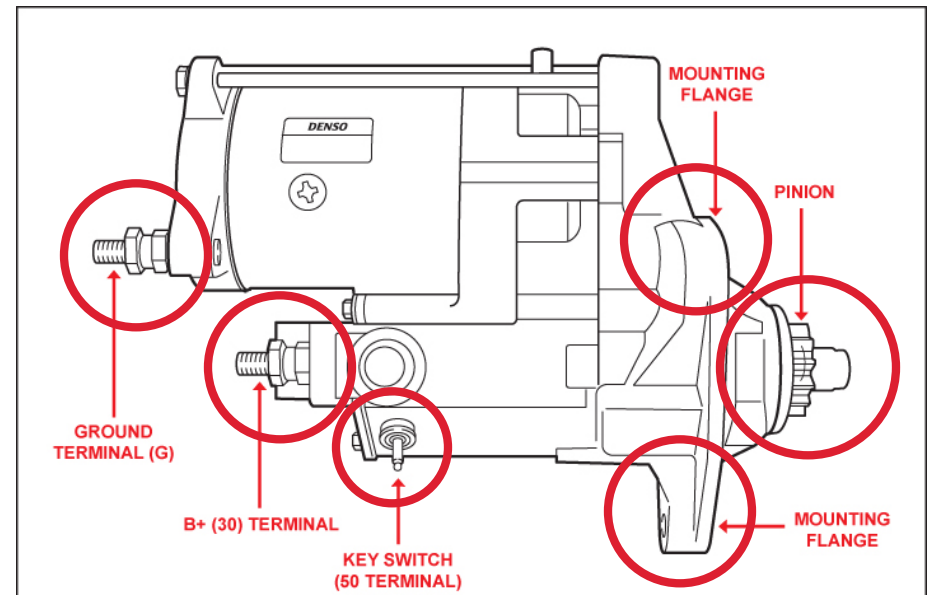

Proceed to vehicle preparation.

Vehicle Preparation

Locate the vehicle battery compartment and remove the battery cover.



Disconnect and isolate the negative (-) battery cable from the negative (-) battery terminal.



Vehicle Preparation

Remove the wheel well protector on the driver side of the vehicle. Retain all mounting hardware.



Proceed to starter removal.

Starter Removal

Before disconnecting cables from the original starter, identify and note location for reassembly.

- **Disconnect & remove all cables from the starter**
- **Temporarily group all positive (+) cables together.**
- **Temporarily group all negative (-) cables together.**

Remove the original starter from the vehicle.

Save the original mounting hardware for the DENSO R5 starter installation.

Proceed to inspection.



Inspection

Inspect the ring gear for burred or damaged teeth.

Rotate the flywheel and observe the condition of the entire ring gear.

Replace any ring gear with damaged or worn teeth.

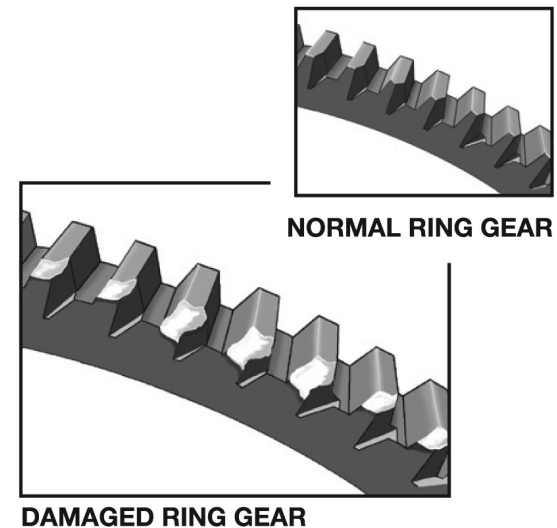
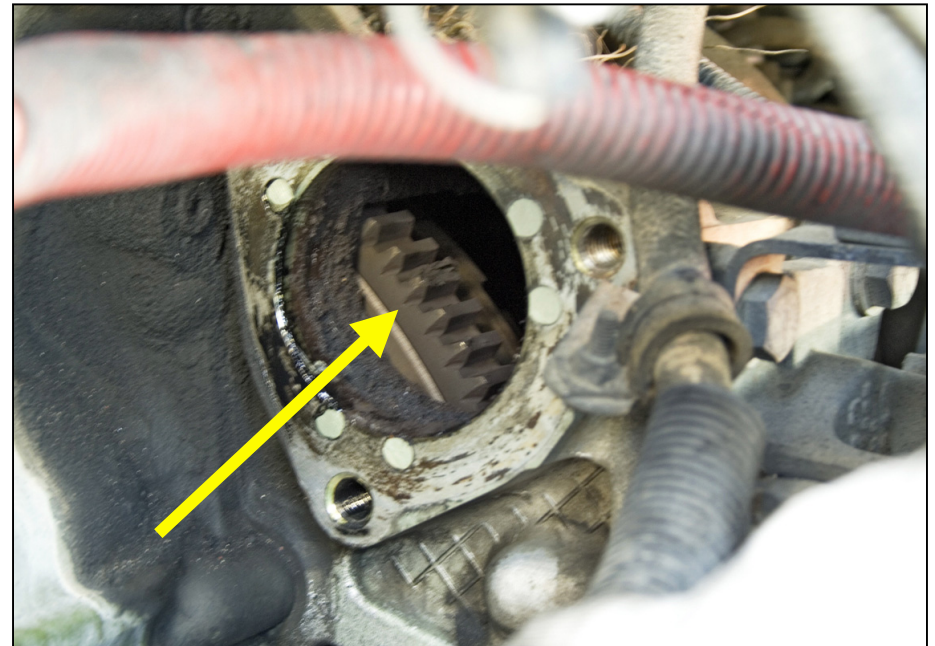

Inspection

Check the condition of all battery cables. If out of specification, clean cable connectors or replace cables.



Proceed to starter installation.

Starter Installation

Temporarily support the R5 starter and secure with the original 3 mounting bolts.

- Ensure the drain tube is in the downward position

Viewed from bottom of vehicle looking up

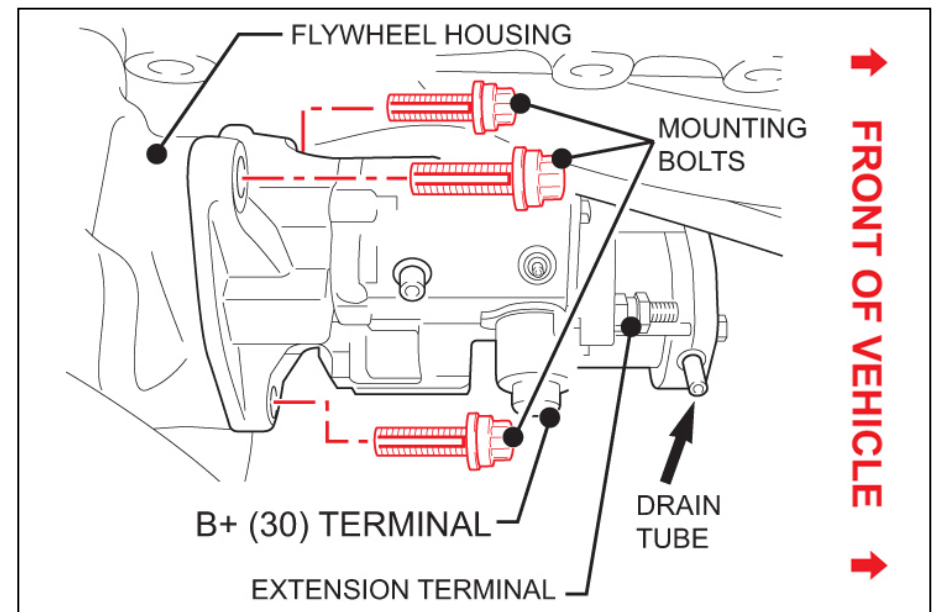
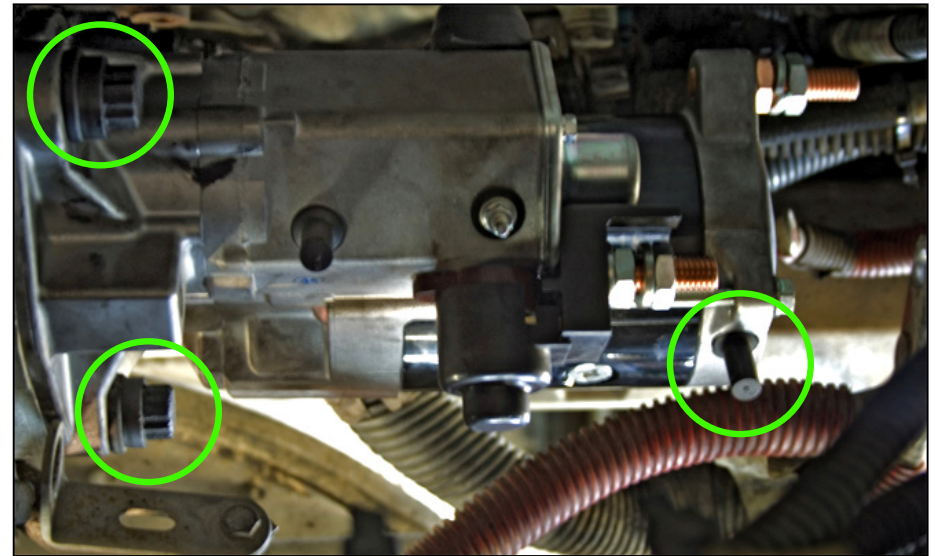

Viewed from bottom of vehicle looking up

Starter Installation

NOTE:
Starter shown from side view with
drain tube in the downward position.

Viewed from side of vehicle



**Torque the mounting bolts to the
specifications indicated in the
Series 60 service manual.**

Viewed from side of vehicle



Starter Installation

Check for minimum clearances of starter to:

1. Engine Block - **4mm** (.16 inches)
2. Frame Rail - **25mm** (1 inch)
3. Heat Source - **30mm** (1.2 inches) (e.g. exhaust manifold)

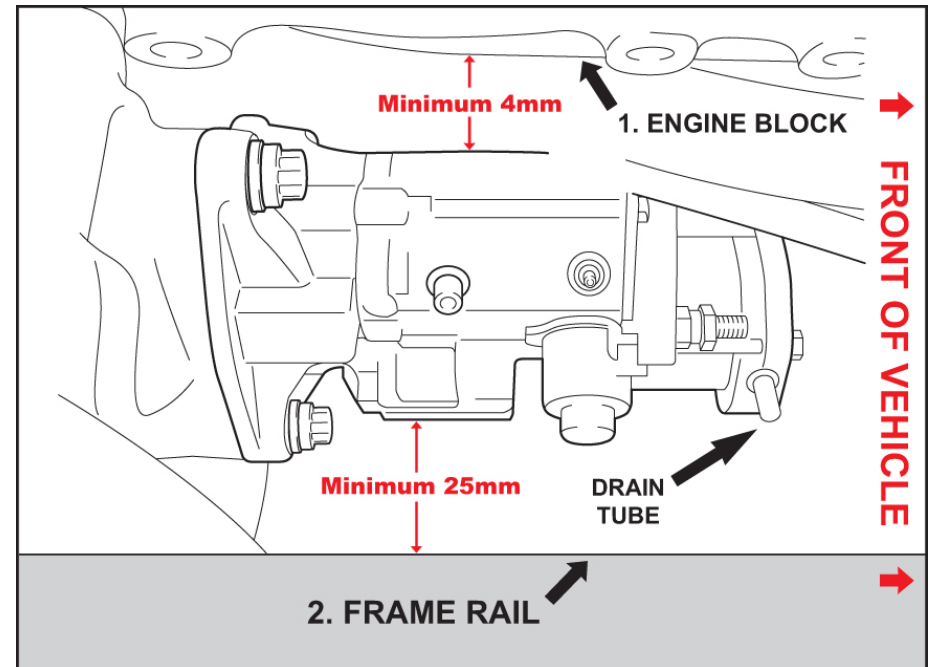

Proceed to wiring assembly.

Starting Motor Overcrank Protection (OCP) Circuit Bypass (if equipped)

The OCP circuit is an option used on many trucks. It utilizes a thermal switch to open the starter relay ground circuit when excessive starter temperatures are reached due to prolonged cranking of the starter motor. This is commonly called over-cranking.

The information below describes the procedure to bypass the OCP circuit when replacing an OCP equipped starter with a DENSO R5 starter.

The presence of OCP can be identified by looking at the original starter (commutator end view). The OCP terminal comes out of the main wire harness and is plugged into the thermal switch at the rear of the starter. The DENSO R5 kW starter does not require or have an external OCP device. However, it is necessary to complete the relay ground circuit when installing an R5 kW in a vehicle originally equipped with this OCP device. This can be accomplished by installing a jumper plug into the OCP wiring harness connector.

- DENSO OCP Jumper Plug Part #053680-8010

Wiring Assembly

(if equipped with over-crank protection)

Location of over-crank protection terminal in original starter.

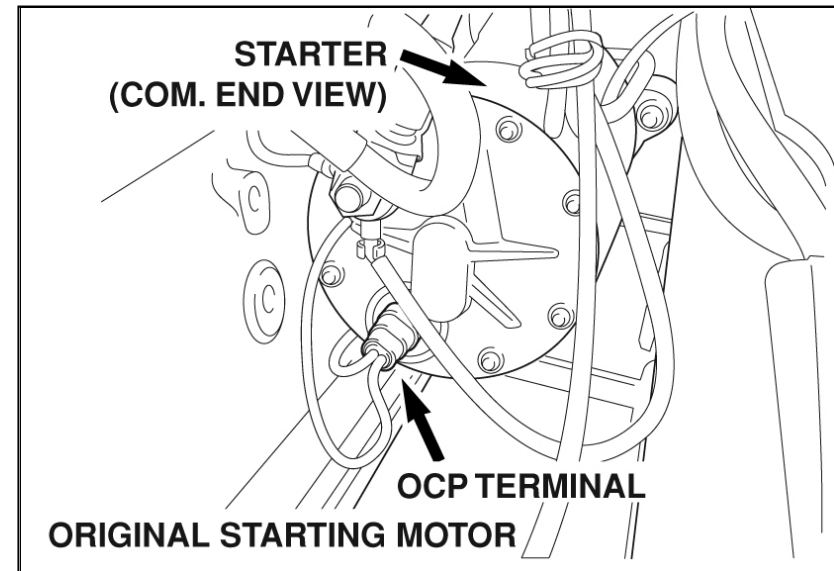

Jumper plug installed in original wire harness.

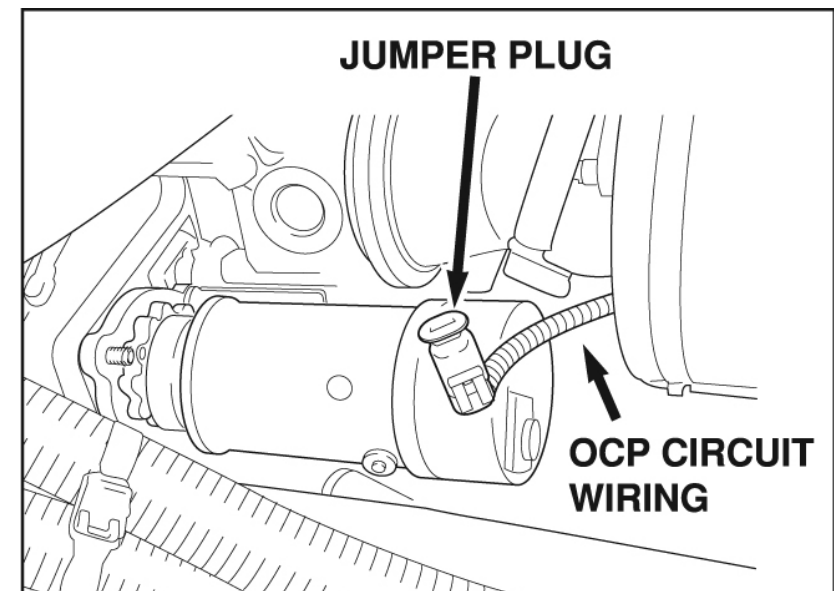

Wiring Assembly

(if equipped with over-crank protection)

Tie off the OCP terminal and jumper plug to the main wire harness to prevent separation due to vibration.

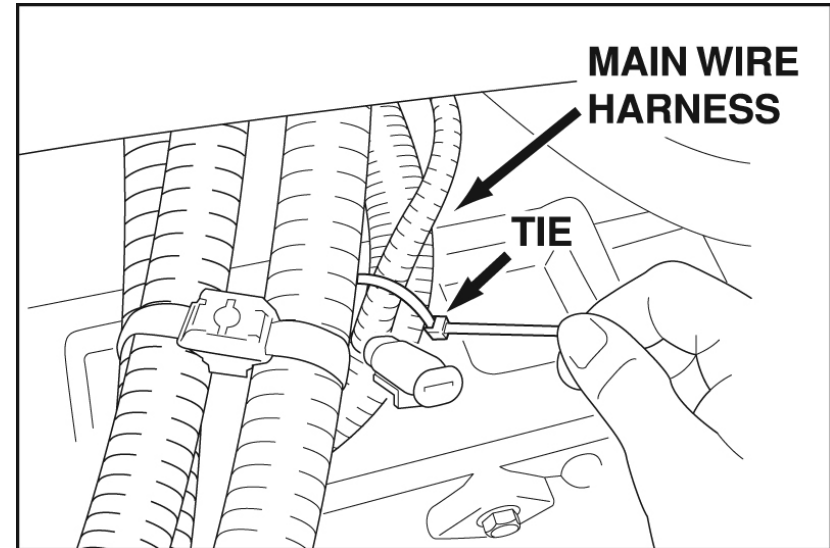

Wiring Assembly

Remove the ties (adjacent to the engine) holding the positive (+) alternator cable in place.

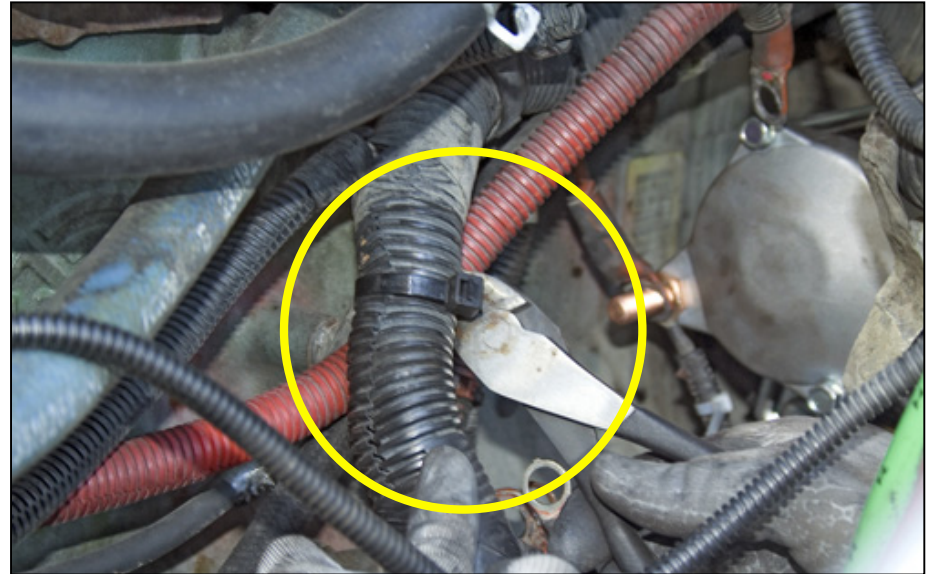

Loosen the cable bracket holding the alternator cable to the engine block.



Wiring Assembly

Carefully maneuver the alternator cable through the cable bracket, toward the starter, to allow sufficient length for proper connection to the B+ (30) terminal.

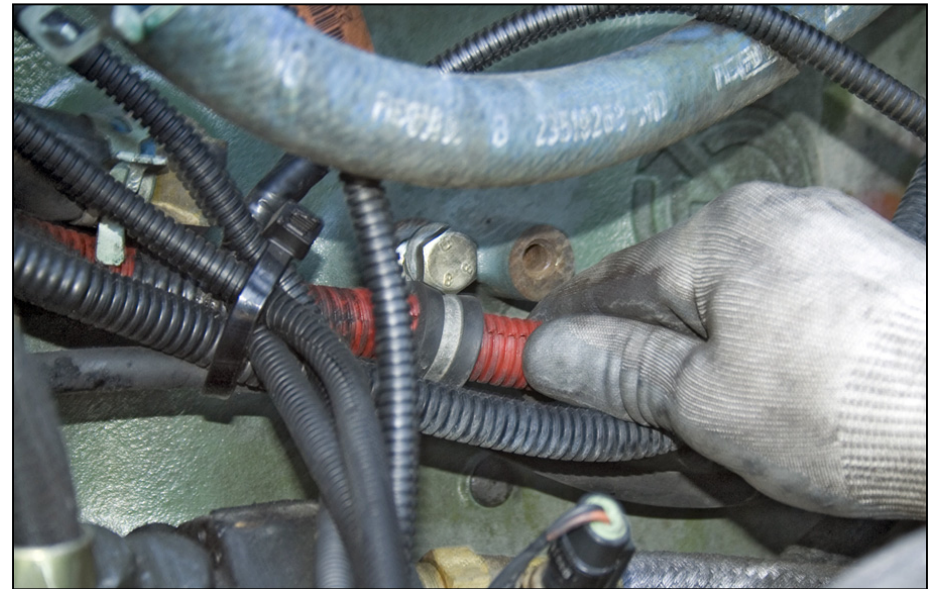

Re-align the cable bracket to the original position and torque to specifications.



Wiring Assembly

Loosen the **B+ battery cable bracket** located under the cab.

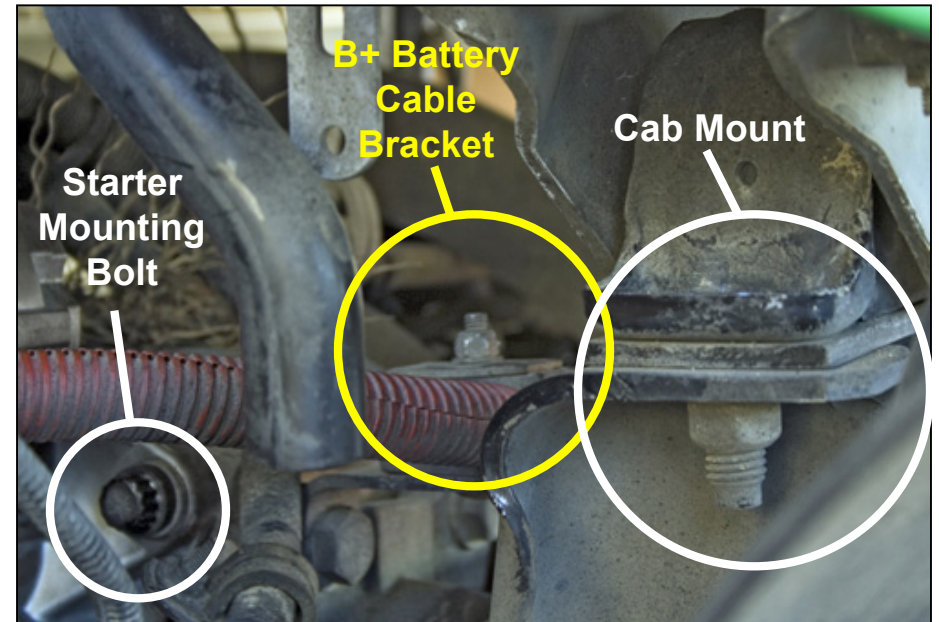

Carefully maneuver the positive (+) battery cable, toward the starter, to allow sufficient length for proper connection to the B+ (30) terminal.



Wiring Assembly

Re-secure the B+ battery cable bracket located under the cab.

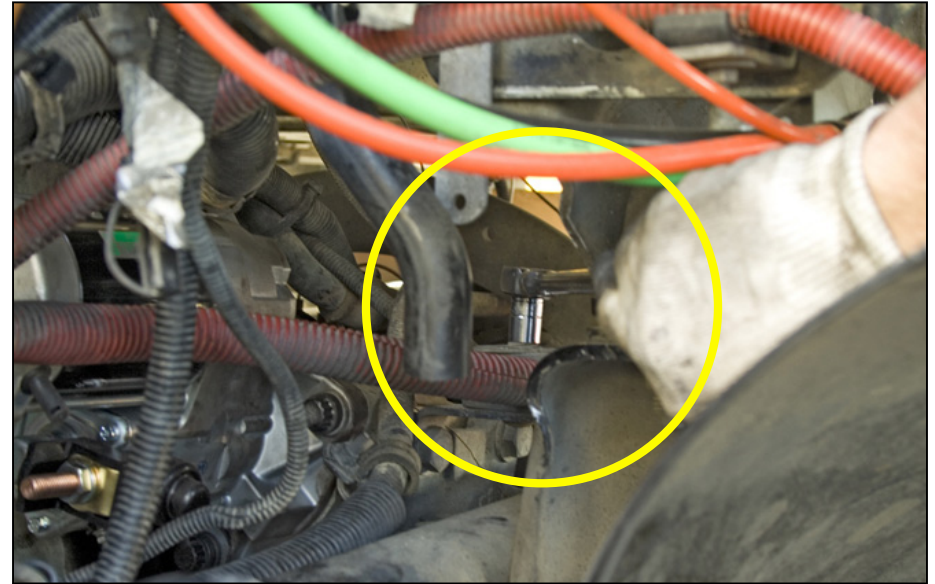

Remove the temporary tie securing the positive (+) cables and wiring.



Wiring Assembly

Extend the key switch wire and relay circuit within the wiring harness protector approximately 1 inch.

Connect the key switch wire to the 50 terminal and secure with retaining nut. Tighten and torque to:

**2.6-4.6 Nm,
27-48 kgf.cm,
1.5-2.2 lbt.ft.**

Do not over-tighten terminal retaining nut.

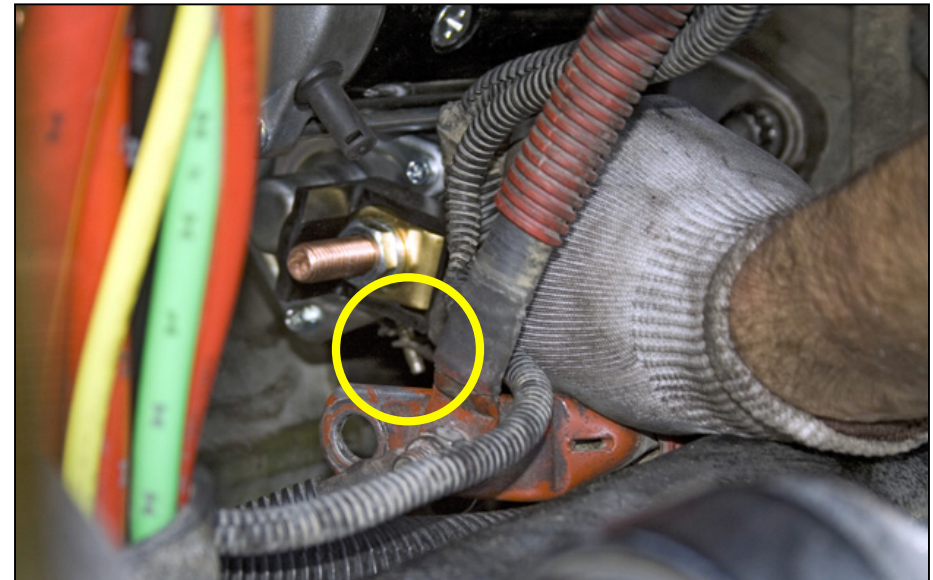
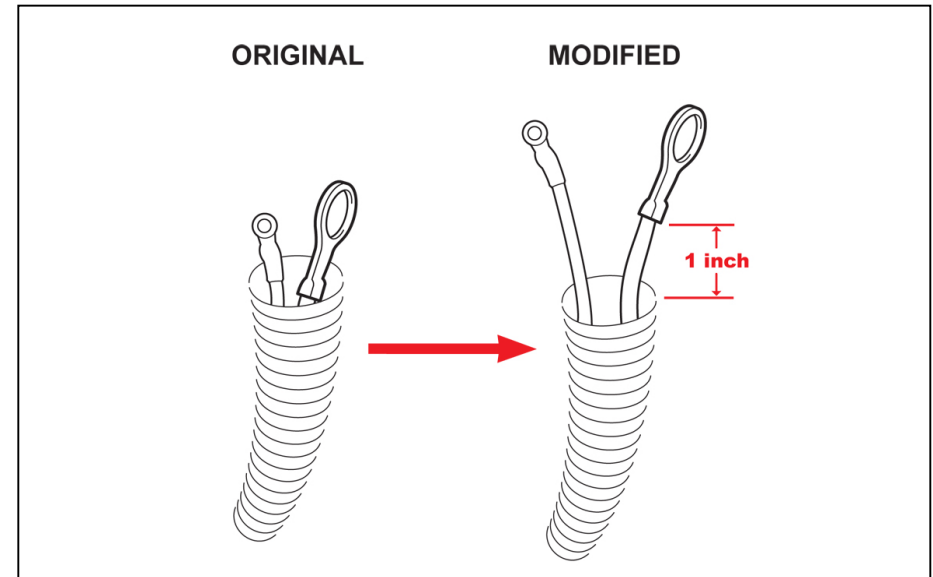

Wiring Assembly

Replace positive (+) cables on the B+ (30) terminal and secure in place with retaining nut.

Tighten and torque B+ (30) terminal retaining nut to:

**23-30 Nm,
239-304 kgf.cm,
17.7-22.0 lbt.ft.**

Do not over-tighten terminal retaining nut.

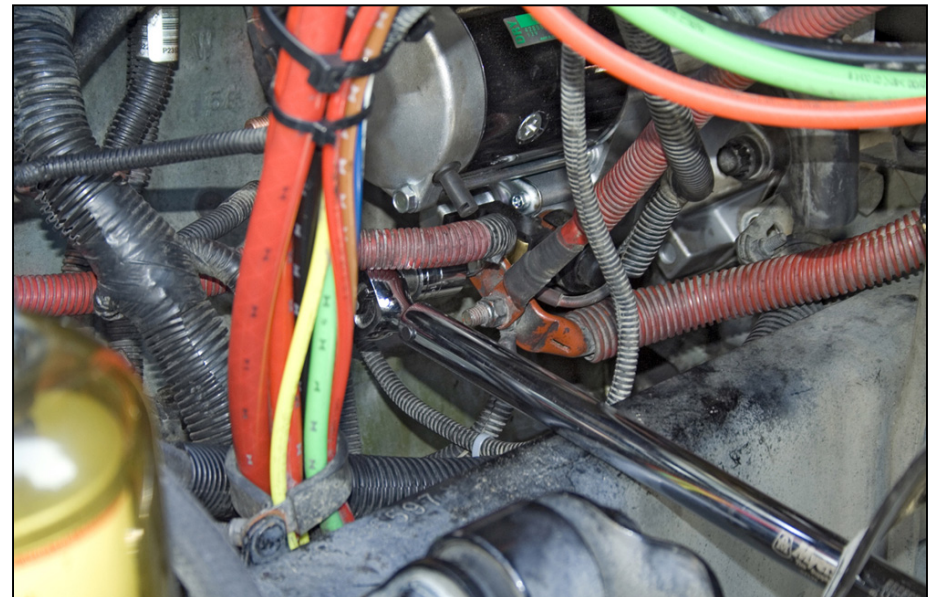

Wiring Assembly

Loosen the engine ground cable from the engine block.

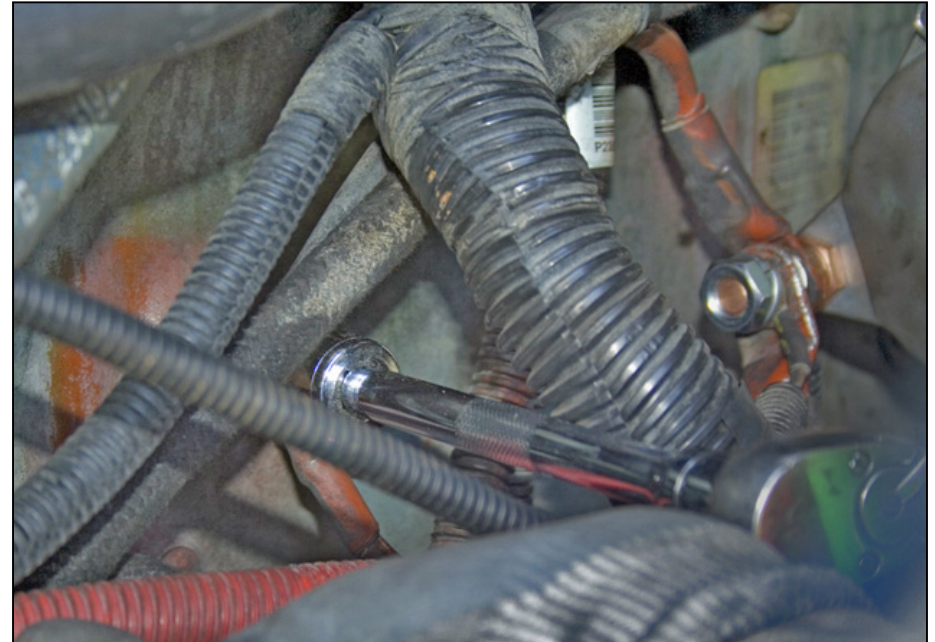

Rotate cable in counter-clockwise direction to allow sufficient length to connect to the starter ground terminal (Terminal G).

Re-torque mounting bolt to engine block according to specifications.

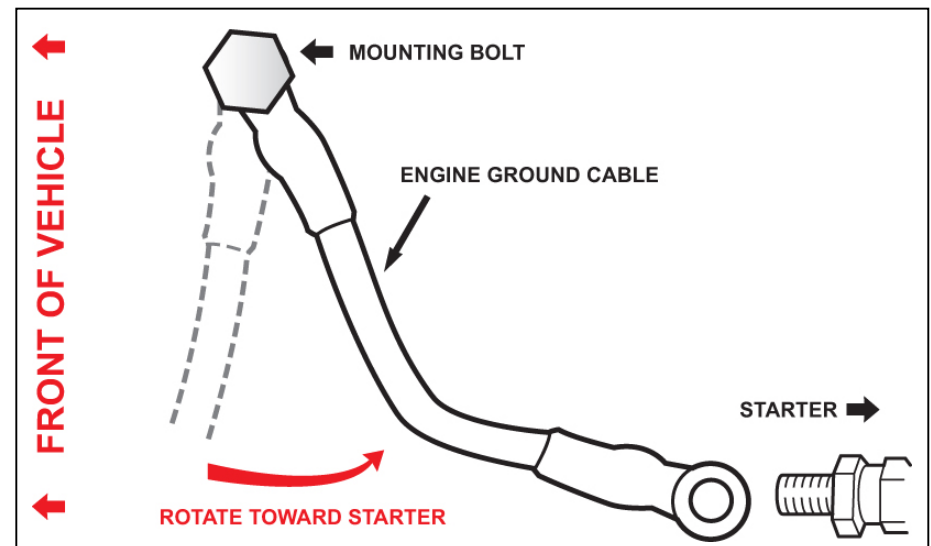

Wiring Assembly

Connect ground cables to the ground terminal (Terminal G) of the starter.

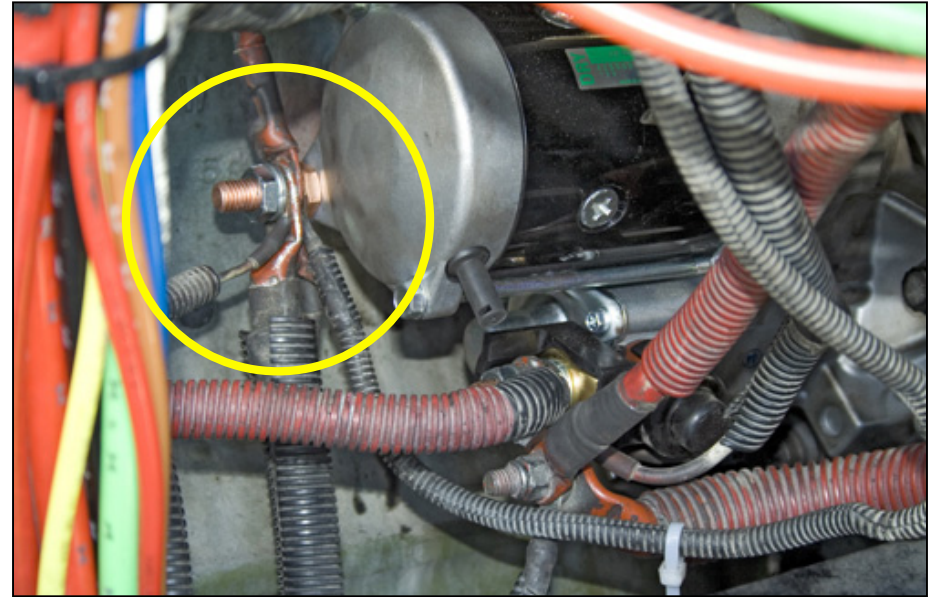

Tighten and torque the Terminal G retaining nut to:

**23-30 Nm,
239-304 kgf.cm,
17.7-22.0 lbt.ft.**

Do not over-tighten terminal retaining nut.



Wiring Assembly

Properly route and re-secure all cable wiring with new cable ties to avoid contact with frame rail and any external heat source.

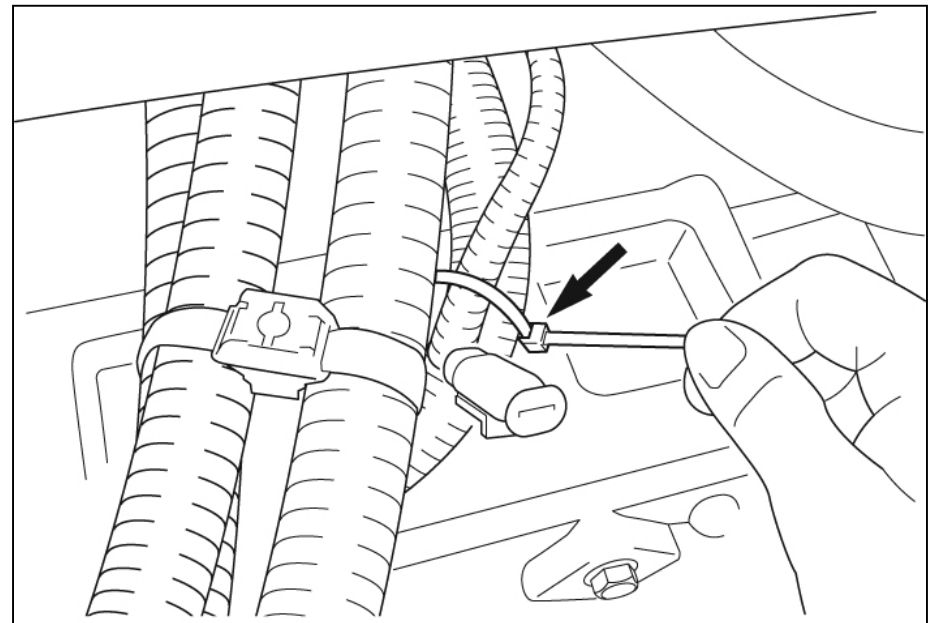
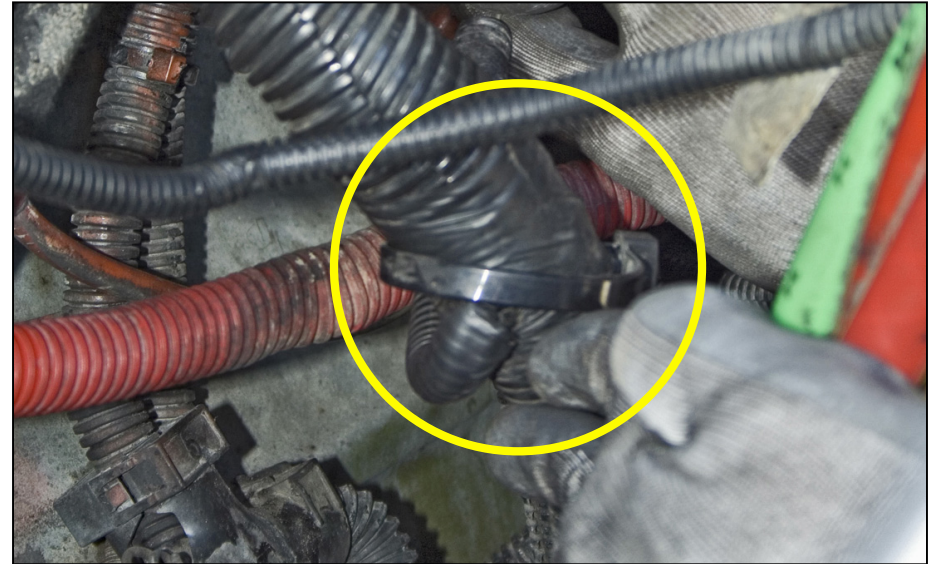

Proceed to inspection after installation.

Inspection After Installation

Re-install the wheel well protector with original hardware.



**Check the voltage of all batteries.
Each battery should be fully charged.**



Inspection After Installation

Cable Voltage Loss Test (Step 1)

1. Connect Voltmeter & Carbon File Loader as shown in Diagram 1.
2. Crank engine & adjust load on Carbon Pile Loader to 500 Amps.
3. Record (+V) value indicated on Voltmeter.

Proceed to Step 2.

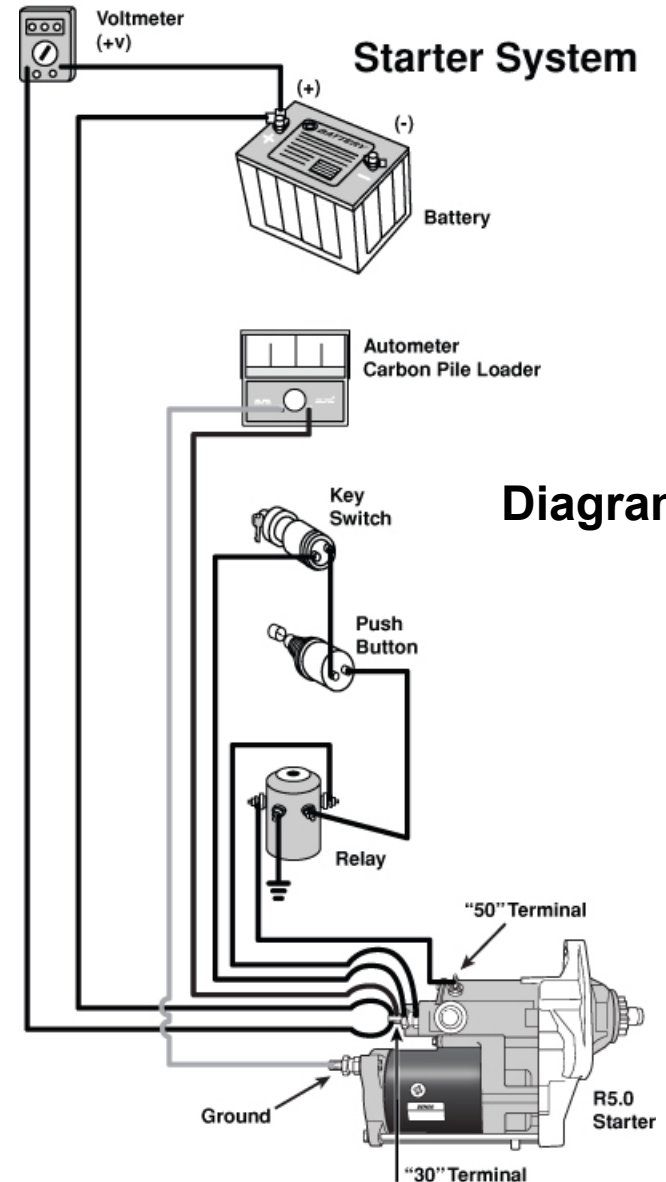

Inspection After Installation

Cable Voltage Loss Test (Step 2)

1. Move Voltmeter to (-) side, as shown.
2. Crank engine & adjust load on Carbon Pile Loader to 500 Amps.
3. Record (-V) value indicated on Voltmeter.
4. Add +V and -V value. Total loss should not exceed 0.5V.

If total loss exceeds 0.5V, repair or replace cable.

In accordance with The Maintenance Council RP129 Section 1(B).

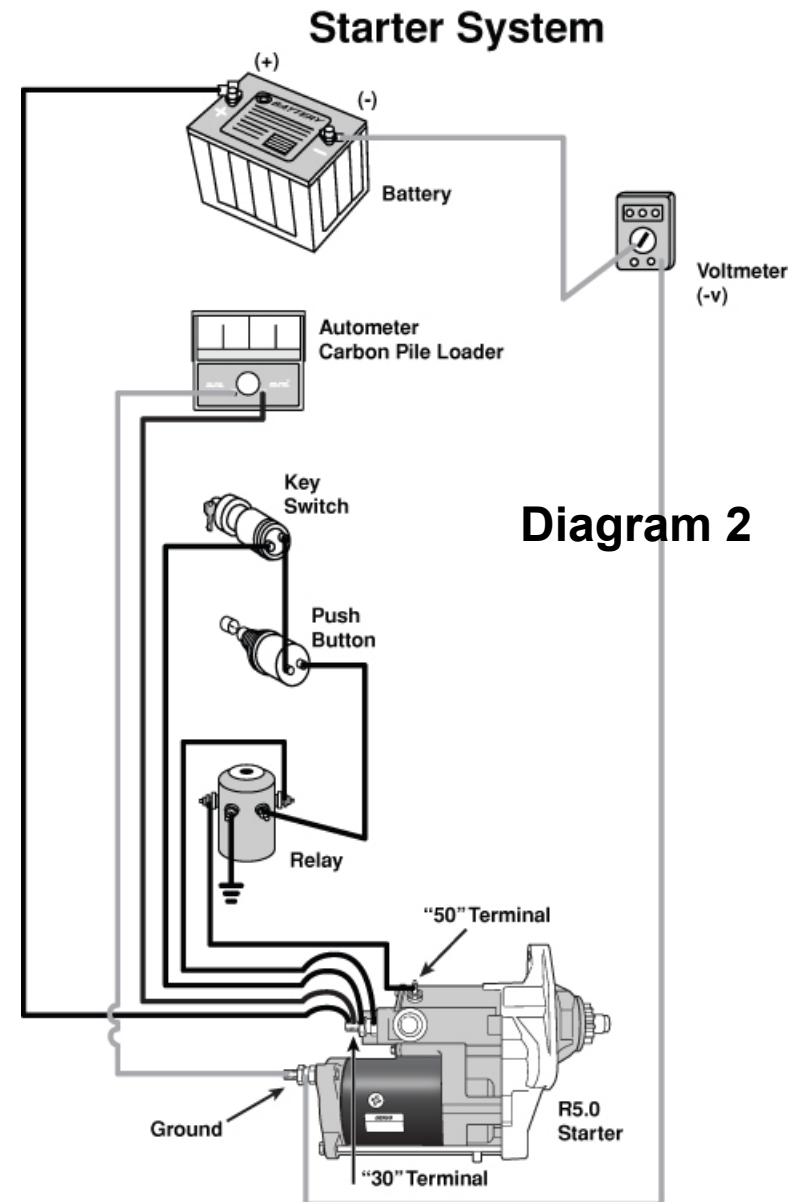

Inspection After Installation

Replace **ALL** removed vehicle components.



Start engine and check for proper operation.



CONGRATULATIONS!

**You have successfully installed the
DENSO R5 Starter.**

**For Additional Assistance or
Technical Support Contact:**

**DENSO Sales California, Inc.
Tech Hotline at 1.800.366.1123**

Free Manuals Download Website

<http://myh66.com>

<http://usermanuals.us>

<http://www.somanuals.com>

<http://www.4manuals.cc>

<http://www.manual-lib.com>

<http://www.404manual.com>

<http://www.luxmanual.com>

<http://aubethermostatmanual.com>

Golf course search by state

<http://golfingnear.com>

Email search by domain

<http://emailbydomain.com>

Auto manuals search

<http://auto.somanuals.com>

TV manuals search

<http://tv.somanuals.com>