

Comfort Glow®

VENTED DECORATIVE NATURAL GAS LOGS OWNER'S OPERATION AND INSTALLATION MANUAL

TESTED AND
LISTED BY



RG A 2-72

APPROVED



We recommend that our products be installed and serviced by professionals who are certified in the U.S. by NFI (National Fireplace Institute).
www.nficertified.org

BRENTWOOD

MODELS LCF18 AND LCF24

WARNING: If the information in this manual is not followed exactly, a fire or explosion may result causing property damage, personal injury or loss of life.

- Do not store or use gasoline or other flammable vapors and liquids in the vicinity of this or any other appliance.
- **WHAT TO DO IF YOU SMELL GAS**
 - Do not try to light any appliance.
 - Do not touch any electrical switch; do not use any phone in your building.
 - Immediately call your gas supplier from a neighbor's phone. Follow the gas supplier's instructions.
 - If you cannot reach your gas supplier, call the fire department.
- Installation and service must be performed by a qualified installer, service agency or the gas supplier.

Save this manual for future reference.

For more information, visit www.desatech.com

Download from Www.Somanuals.com. All Manuals Search And Download.

WARNING: Improper installation, adjustment, alteration, service or maintenance can cause injury or property damage. Refer to this manual for correct installation and operational procedures. For assistance or additional information consult a qualified installer, service agency or the gas supplier.

WARNING: This appliance is for installation only in a solid-fuel burning masonry or UL127 factory-built fireplace, constructed of noncombustible material and connected to a working flue. (See page 6 for minimum flue opening.

WARNING: This is a decorative gas appliance. It uses air (oxygen) from the room in which it is installed. Provisions for adequate combustion and ventilation air must be provided. Refer to the *National Fuel Gas Codes, ANSI Z233.1/NFPA 54, Section 5.3, Air for Combustion and Ventilation.*

This appliance may be installed in an aftermarket,* permanently located, manufactured (mobile) home, where not prohibited by local codes.

This appliance is only for use with the type of gas indicated on the rating plate.

* Aftermarket: Completion of sale, not for purpose of resale, from the manufacturer

State of Massachusetts: The installation must be made by a licensed plumber or gas fitter in the Commonwealth of Massachusetts.

TABLE OF CONTENTS

Safety Information	3	Technical Service	12
Product Identification	4	Replacement Parts	12
Local Codes	4	Troubleshooting	13
Unpacking	5	Illustrated Parts Breakdown and Parts List	16
Optional Product Features	5	Accessories	18
Installation	5	Warranty Information	Back Page
Operating Appliance	10		
Cleaning and Maintenance	12		
Service Hints	12		

SAFETY INFORMATION

⚠ WARNING: This product contains and/or generates chemicals known to the State of California to cause cancer or birth defects or other reproductive harm.

⚠ WARNING: Keep flue open when operating unit.

IMPORTANT: Read this owner's manual carefully and completely before trying to assemble, operate or service this log set. Improper use of this log set can cause serious injury or death from burns, fire, explosion, electrical shock and carbon monoxide poisoning.

⚠ DANGER: Carbon monoxide poisoning may lead to death!

Carbon Monoxide Poisoning: Early signs of carbon monoxide poisoning resemble the flu, with headaches, dizziness or nausea. If you have these signs, the log set may not be working properly. **Get fresh air at once!** Have log set serviced. Some people are more affected by carbon monoxide than others. These include pregnant women, people with heart or lung disease or anemia, those under the influence of alcohol and those at high altitudes.

Natural Gas: Natural gas is odorless. An odor-making agent is added to the gas. The odor helps you detect a gas leak. However, the odor added to the gas can fade. Gas may be present even though no odor exists.

Make certain you read and understand all warnings. Keep this manual for reference. It is your guide to safe and proper operation of this log set.

⚠ WARNING: Any change to this log set or its controls can be dangerous.

⚠ WARNING: Do not use a blower insert, heat exchanger insert or other accessory not approved for use with this appliance.

⚠ WARNING: This appliance is equipped for natural gas. An optional propane/LP conversion kit must be installed for use with propane/LP gas.

⚠ WARNING: Do not allow fans to blow directly into the fireplace. Avoid any drafts that alter burner flame patterns.

⚠ WARNING: Installed decorative glass door enclosures must be fully opened when operating this gas appliance.

Due to high temperatures, the appliance should be located out of traffic and away from furniture and draperies.

Do not place clothing or other flammable material on or near the appliance. Never place any objects on the appliance.

Appliance assembly becomes very hot when in use. Keep children and adults away from hot surface to avoid burns or clothing ignition. Appliance will remain hot for a time after shutdown. Allow surface to cool before touching.

Carefully supervise young children when they are in the room with appliance.

You must operate this appliance with a fireplace screen in place. Make sure fireplace screen is closed before running appliance.

Keep the appliance area clear and free from combustible materials, gasoline and other flammable vapors and liquids.

SAFETY INFORMATION

Continued

1. If you smell gas
 - shut off gas supply
 - do not try to light any appliance
 - do not touch any electrical switch; do not use any phone in your building
 - immediately call your gas supplier from a neighbor's phone. Follow the gas supplier's instructions
 - if you cannot reach your gas supplier, call the fire department
2. Never install the log set
 - in a recreational vehicle
 - where curtains, furniture, clothing, or other flammable objects are less than 42 inches from the front, top, or sides of the log set
 - in high traffic areas
 - in windy or drafty areas
3. Before installing in a solid fuel burning fireplace, the chimney flue and firebox must be cleaned of soot, creosote, ashes and loose paint by a qualified chimney cleaner. Creosote will ignite if highly heated. Inspect chimney flue for damage. If damaged, repair flue before operating appliance.
4. This log set is designed to be smokeless. If logs ever appear to smoke, turn off appliance and call a qualified service person. **Note:** During initial operation, slight smoking could occur due to log curing and the burning of manufacturing residues. You may wish to add more ventilation by opening a window.
5. To reduce the creation of soot, follow the instructions in *Cleaning and Maintenance*, page 12.
6. The installation and provisions for combustion and ventilation air must conform with the *National Fuel Gas Code, ANSI Z223.1/NFPA 54, Section 5.3, Air for Combustion and Ventilation*.
7. Do not run log set
 - where flammable liquids or vapors are used or stored
 - under dusty conditions
8. Do not burn solid fuel in the fireplace after installing the log set. Do not use this log set to cook food or burn paper or other objects.
9. Do not use appliance if any part has been exposed to or under water. Immediately call a qualified service technician to inspect the room appliance and to replace any part of the control system (if using GA9050A or GA9150A) and any gas control which has been under water.

10. To help prevent breakage, new logs must be broken-in (see *Curing Logs* page 11).
11. Turn log set off and let cool before servicing, installing, or repairing. Only a qualified service person should install, service, or repair log set.
12. Provide adequate clearances around air openings.

PRODUCT IDENTIFICATION

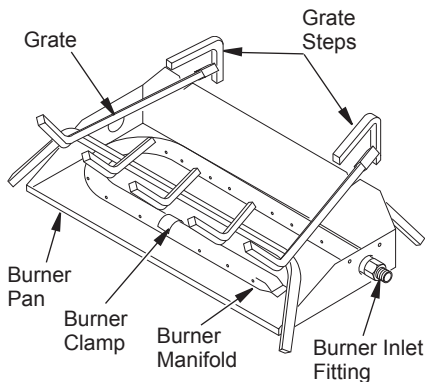

Figure 1 - Product Identification (Dual Burner Shown)

Hearth Kit Model _____
Serial Number _____
Log Set Model _____

LOCAL CODES

Install and use log set with care. Follow all local codes. In the absence of local codes, use the latest edition of the *National Fuel Gas Code ANSI Z223.1/NFPA 54**.

*Available from:

American National Standards Institute, Inc.
1430 Broadway
New York, NY 10018
National Fire Protection Association, Inc.
Batterymarch Park
Quincy, MA 02269

UNPACKING

CAUTION: Do not remove the data plates from the burner pan. The data plates contain important product information.

1. Remove logs, hearth kit, pan materials, and hardware from carton.
2. Remove all protective packaging applied to logs and base for shipment.
3. Check all items for any shipping damage. If damaged, promptly inform dealer where you bought the product.

OPTIONAL PRODUCT FEATURES

ON/OFF SAFETY VALVE/PILOT KIT AND PROPANE/LP CONVERSION

An optional valve/safety pilot kit with a piezo ignitor is available for this appliance. This system requires no matches, batteries, or other sources to light. You must use this optional system for LP conversion. See *Accessories*, page 18.

REMOTE CONTROL READY (MILLIVOLT) SAFETY VALVE/PILOT KIT

An optional millivolt valve/safety pilot kit with a piezo ignitor is available for this appliance. This system requires no matches, batteries, or other sources to light. This system may be connected to a wall switch or hand-held wireless remote control. See *Accessories*, page 18.

REMOTE CONTROL ACCESSORIES

There is an optional hand-held ON/OFF remote control that can be purchased separately for this log set. You must use the millivolt valve/safety pilot kit to use remote accessories with this appliance. See *Accessories*, page 18.

A wall switch is also available for this appliance. You must use the millivolt valve/safety pilot kit to use the wall switch with this appliance. See *Accessories*, page 18.

INSTALLATION

CAUTION: Do not remove the data plates attached to the burner pan. The data plates contain important warranty information.

WARNING: Before installing in a solid fuel burning fireplace, the chimney flue and firebox must be cleaned of soot, creosote, ashes and loose paint by a qualified chimney cleaner. Creosote will ignite if highly heated. A dirty chimney flue may create and distribute soot within the house. Inspect chimney flue for damage. If damaged, repair flue before operating appliance.

NOTICE: Installation, service, and repair of this appliance must be performed by a qualified installer, service agency, company or gas supplier experienced with this type of gas appliance. Only factory authorized components listed in these instructions may be used in accordance with the manufacturer's instructions and all codes and requirements of the authority having jurisdiction. Any modifications to this kit, or use of unauthorized components or accessory items will void the manufacturer's warranty, and may result in a hazardous condition.

FLUE OPENING SPECIFICATIONS

Note: This vented appliance must be installed only in a solid-fuel burning fireplace with a working flue and constructed of noncombustible material.

The charts in Figure 2, page 6 indicate technical information regarding the installation of your gas log set. Please make sure that all of the specifications shown are applicable before installation is attempted.

INSTALLATION

Continued

The fireplace must include a working flue and venting system with the minimum openings shown in the Figure 2.

Model	Burner Description	BTU Input (Natural Gas)	Min. Vent Opening
LCF18	18" Dual	55,000	8"
LCF24	24" Dual	60,000	8"

Minimum Fireplace Dimensions				
Model	Front Width	Back Width*	Depth	Height
LCF18	28"	18"	14"	16"
LCF24	29.75"	17"	15.5"	18"

* At depth Indicated

Fuel Inlet Pressure Specifications (W.C.)		
	Min.	Max.
N.G.	5.5"	10.5"

Burner Orifice Sizing		
Log Size	Natural Gas	
	In.	Num.
18"	.120	31
24"	.129	30

Figure 2 - Technical Information Charts

CHECK GAS TYPE

Use only natural gas. If your gas supply is not natural gas, you must install ON/OFF Safety Valve/Pilot Kit (see *Accessories*, page 18). Call dealer where you bought log set.

If the fireplace does not have a gas supply shutoff valve, one must be installed.

VENTING SPECIFICATIONS FOR INSTALLATION

The fireplace chimney flue and vent must be drafted properly. To check the vent for proper drafting: Light a tightly rolled newspaper on one end and place it at the inside front edge of the fireplace. Observe the smoke and be sure the vent is properly drawing it up the chimney. If the smoke spills out into the room, extinguish the flame and remove any obstruction until proper venting is achieved.

The chimney flue must remain open a minimum of 3" at all times during the operation of this log set.

INSTALLING DAMPER CLAMP

Secure the damper stop clamp provided to the leading edge of the damper as shown in Figure 3. If for any reason this clamp doesn't work on your fireplace, another suitable clamp or permanent stop must be installed, or the damper blade must be cut or removed.

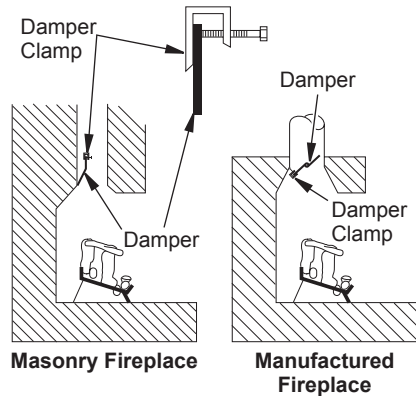

Figure 3 - Attaching Damper Clamp

CONNECTING TO GAS SUPPLY

⚠ WARNING: A qualified service person must connect log set to gas supply. Follow all local codes.

Installation Items Needed

Before installing log set, make sure you have the items listed below.

- piping (check local codes)
- sealant (resistant to Propane/LP gas)
- equipment shutoff valve
- test gauge connection
- adjustable (crescent) wrench or pliers
- sediment trap
- tee joint
- pipe wrench

INSTALLATION

Continued

⚠ CAUTION: Use only new, black iron or steel pipe. Internally-tinned copper tubing may be used in certain areas. Check your local codes. Use pipe of 1/2" diameter or greater to allow proper gas volume to log set. If pipe is too small, undue loss of volume will occur.

Installation must include a equipment shutoff valve, union, and plugged 1/8" NPT tap. Locate NPT tap within reach for test gauge hook up. NPT tap must be upstream from log set (see Figure 4).

IMPORTANT: Install equipment shutoff valve in an accessible location. The equipment shutoff valve is for turning on or shutting off the gas to the appliance.

Approved Flexible Gas Hose (if allowed by local codes)

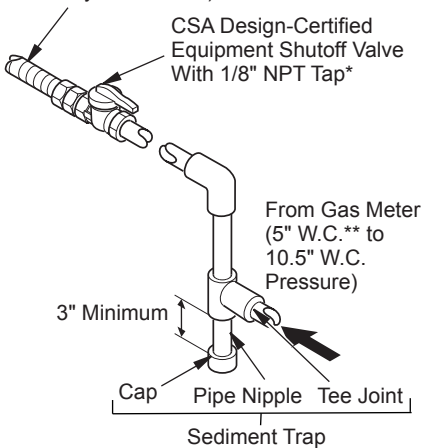

Figure 4 - Gas Connection

* Purchase the optional CSA design-certified equipment shutoff valve from your dealer. See *Accessories*, page 18.

** Minimum inlet pressure for purpose of input adjustment.

Apply pipe joint sealant lightly to male NPT threads. This will prevent excess sealant from going into pipe. Excess sealant in pipe could result in a clogged burner injector.

⚠ WARNING: Use pipe joint sealant that is resistant to liquid petroleum (LP) gas.

We recommend that you install a sediment trap in supply line as shown in Figure 4. Locate sediment trap where it is within reach for cleaning. Install in piping system between fuel supply and appliance. Locate sediment trap where trapped matter is not likely to freeze. A sediment trap traps moisture and contaminants. This keeps them from going into log set controls. If sediment trap is not installed or is installed wrong, log set may not run properly.

CHECKING GAS CONNECTIONS

⚠ WARNING: Test all gas piping and connections, internal and external to unit, for leaks after installing or servicing. Correct all leaks at once.

⚠ WARNING: Never use an open flame to check for a leak. Apply a noncorrosive leak detection fluid to all joints. Bubbles forming show a leak. Correct all leaks at once.

PRESSURE TESTING GAS SUPPLY PIPING SYSTEM

Test Pressures In Excess Of 1/2 PSIG (3.5 kPa)

1. Disconnect log set and its individual equipment shutoff valve from gas supply piping system.
2. Cap off open end of gas pipe where equipment shutoff valve was connected.
3. Pressurize supply piping system by either using compressed air or opening main gas valve located on or near gas meter.
4. Check all joints of gas supply piping system. Apply noncorrosive leak detection fluid to gas joints. Bubbles forming show a leak.
5. Correct all leaks at once.
6. Reconnect log set and equipment shutoff valve to gas supply. Check reconnected fittings for leaks.

INSTALLATION

Continued

Test Pressures Equal To or Less Than 1/2 PSIG (3.5 kPa)

1. Close equipment shutoff valve (see Figure 5).
2. Pressurize supply piping system by either using compressed air or opening main gas valve located on or near gas meter.
3. Check all joints from gas meter to equipment shutoff valve (see Figure 5). Apply noncorrosive leak detection fluid to gas joints. Bubbles forming show a leak.
4. Correct all leaks at once.

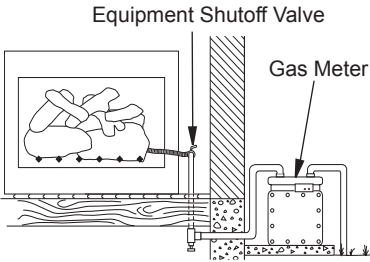

Figure 5 - Checking Gas Joints

HEARTH KIT ASSEMBLY AND INSTALLATION

1. Determine which side the gas line will be coming into the fireplace.
2. Using a hammer and screw driver, remove knockout plug from the side of the pan that corresponds to the gas line (see Figure 6).
3. Unscrew burner inlet fitting from burner manifold.
4. Place burner manifold in pan with threaded opening facing open knockout plug.
5. Using thread sealant (resistant to the action of propane/LP gas) on larger end of fitting, screw the burner inlet fitting through hole and into burner manifold (see Figure 6). Tighten using a wrench.
6. Using burner clamp, screw, and nut provided, assemble clamp to pan ("U" style and triple burners only). This will hold the burner manifold in place.
7. If using optional GA9050A kit, go to *Optional GA9050A On/Off Safety Valve/Pilot Kit* section for installation instructions. If using optional GA9150A kit, follow instructions included with kit for installation and operation.

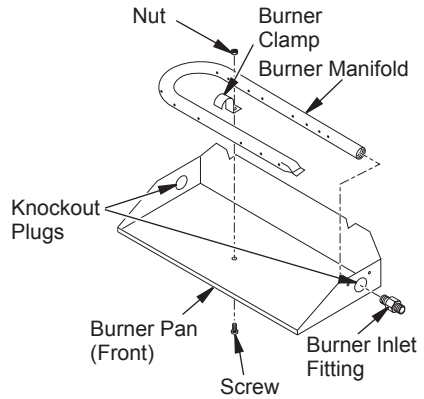

Figure 6 - Installing Burner

Installation and Gas Connection

1. Place the burner pan assembly in the center of the fireplace floor. Make sure the front of pan faces forward.
2. Thread the gas supply fitting to the fireplace gas supply pipe. Use thread sealant.
3. Install adapter fitting onto the burner inlet fitting using thread sealant on male threads of burner inlet fitting (see Figure 7). Adjust to most convenient position.
4. Install the gas connector tube to the gas supply fitting. Carefully shape tube to attach to adapter fitting. Be careful not to cause kinks in tube.

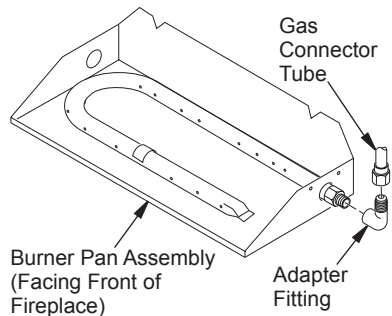

Figure 7 - Connecting Gas to Appliance

INSTALLATION

Continued

OPTIONAL GA9050A ON/OFF SAFETY VALVE/PILOT KIT

For additional convenience and safety, or for propane/LP conversion, an optional ON/OFF safety valve/pilot kit is available. See *Accessories*, page 18.

⚠ WARNING: You must use a ON/OFF safety valve/pilot kit for propane/LP conversion.

TESTING BURNER FOR LEAKS

1. Generously apply noncorrosive leak detection fluid to all connections.

⚠ WARNING: Never check for gas leaks with open flame.

2. Light the burner with the shutoff valve no more than half open and holding a match slightly in front of the pan (see *Lighting Instructions*, page 10).
3. Inspect all connections for bubbles, raw gas odor, or flame from any area other than the burner (leaks). If leaks are detected, shut off the gas valve immediately. Tighten, or reassemble the loose connection(s) using pipe joint compound until burner system is leak free.
4. When the burner is tested and leak free, observe the individual tongues of flame on the burner. **Note:** The burner design includes more ports on the outside of the bar. Make sure that all ports are clear and producing flame evenly across the burner. If any ports appear blocked, clear them by removing the burner manifold and reaming the ports with a modified paper clip or other suitable tool.
5. When finished testing, turn the gas shutoff valve OFF to extinguish all flames.

ADDING PAN MATERIAL

1. Open the bag of ash bed material (vermiculite) and spread it evenly across the burner pan to the top. You may overflow the front and sides of the pan to cover the entire pan and connecting hardware. Do not cover GA9050A or GA9150A valve.
2. Open the glowing embers and evenly cover the ash bed material (vermiculite) in the burner pan.

INSTALLING THE GRATE AND LOGS

1. Place the grate over the burner pan where the two outer horizontal supports on the grate fit into the two pan positioning notches in the rear vertical edge of the pan.
2. Slide the two rear log grate steps over the two outer horizontal supports on the grate as shown in Figure 8.
3. Place the back log onto the grate steps (see Figure 9).
4. Place the front log(s) on the grate and slide forward against the front bars on the grate (see Figure 9).
5. Place three middle logs on top of bottom logs (see Figure 10, page 10).
6. Place the smaller top logs onto the bottom logs (see Figure 11, page 10). Leave as much open space between logs as possible to minimize flame impingement and sooting. **Note:** Logs may chip if they are handled roughly or if hit together while being placed.

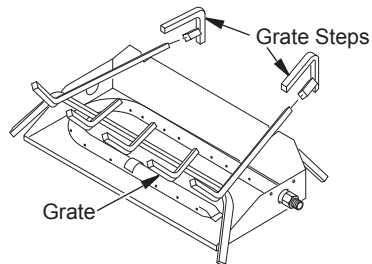

Figure 8 - Installing Grate (Pan Material Not Shown)

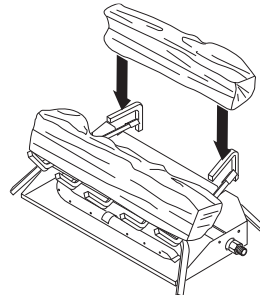

Figure 9 - Installing Bottom Logs

INSTALLATION

Continued

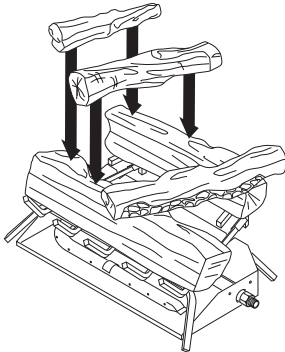

Figure 10 - Installing Middle Logs

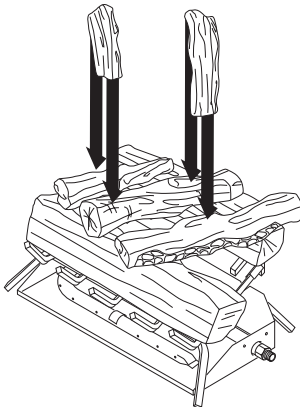

Figure 11 - Installing Top Logs

OPERATING APPLIANCE

**FOR YOUR SAFETY
READ BEFORE LIGHTING**

⚠ WARNING: Keep flue open when operating unit.

⚠ WARNING: If you do not follow these instructions exactly, a fire or explosion may result causing property damage, personal injury or loss of life.

BEFORE LIGHTING smell all around the appliance area for gas. Be sure to smell next to the floor because some gas is heavier than air and will settle on the floor.

WHAT TO DO IF YOU SMELL GAS

- Do not try to light any appliance.
- Do not touch any electric switch; do not use any phone in your building.
- Immediately call your gas supplier from a neighbor's phone. Follow the gas supplier's instructions.
- If you cannot reach your gas supplier, call the fire department.

LIGHTING INSTRUCTIONS

1. **STOP!** Read the safety information, above.
2. Turn the gas shutoff valve to **OFF**.
3. Wait five (5) minutes to clear out any gas. If you then smell gas **STOP!** Follow the safety information above. If you don't smell gas, go on to the next step.
4. Light a match and lay it on top of the pan material about 2" from the end of the supply side of the pan
5. Slowly turn the gas shutoff valve **ON** until the burner ignites. If the burner doesn't ignite within 10 seconds with the match burning, turn the shutoff valve **OFF** and repeat steps 1 through 4 again.

GAS SHUTOFF VALVE OPERATION

Flame Adjustment

Adjust the flame **ON/OFF** by turning the gas shutoff valve counterclockwise ↶ to open or clockwise ↷ to close, as necessary.

OPERATING APPLIANCE

Continued

Shutting Off Appliance

Turn gas shutoff valve clockwise  to the OFF position.

CURING LOGS



During the 2-3 hour appliance break-in period, you may detect an odor from the appliance as the various paints and compounds used in the manufacturing of this log set cure. This is a normal and temporary situation that is not cause for alarm. However, you may want to provide extra ventilation to the room during this time.

To ensure proper curing of the logs:

- Ignite a 2" flame and maintain it for 1 hour.
- Burn the logs in consecutive 1 hour periods raising the flame an additional 2" to full flame height for a total of three hours.

OPERATING INSTRUCTIONS FOR GA9050A

Note: Operation instructions for GA9150A Remote Ready Valve/Pilot Kit will be included with the kit.

1. STOP! Read the safety information, page 10.
2. Make sure equipment shutoff valve is fully open.
3. Press in and turn control knob clockwise  to the OFF position.
4. Wait five (5) minutes to clear out any gas. Then smell for gas around log set and near floor. If you smell gas, STOP! Refer to the *National Fuel Gas Codes, ANSI Z233.1/NFPA 54, Section 5.3, Air for Combustion and Ventilation*. If you don't smell gas, go to the next step.
5. Turn control knob counterclockwise  to the PILOT position and press in. Keep control knob pressed in for five (5) seconds.

Note: You may be running this log set for the first time after hooking up to gas supply. If so, the control knob may need to be pressed in for 30 seconds. This will allow air to bleed from the gas system.

- If control knob does not pop up when released, contact a qualified service person or gas supplier for repairs.

6. With control knob pressed in, push down and release ignitor button. This will light pilot. The pilot is attached to the rear of the front burner. If needed, keep pressing ignitor button until pilot lights.

Note: If pilot does not stay lit, contact a qualified service person or gas supplier for repairs. Until repairs are made, light pilot with match.

7. Keep control knob pressed in for 30 seconds after lighting pilot. After 30 seconds, release control knob.

Note: If pilot goes out, repeat steps 3 through 7.

8. Turn control knob counterclockwise  to the ON position. Burner should light. If burner does not light, call a qualified service person.

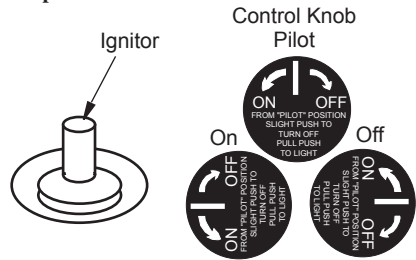

Figure 12 - Ignitor and Control Knob

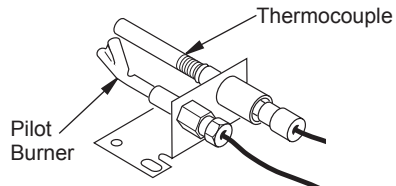





Figure 13 - Thermocouple and Pilot

TO TURN OFF GAS TO APPLIANCE

Shutting Off Appliance

1. Turn control knob clockwise  to the PILOT position.
2. Press in and turn control knob clockwise  to the OFF position.

Shutting Off Burner Only (pilot stays lit)

- Turn control knob clockwise  to the PILOT position.

CLEANING AND MAINTENANCE

- Keep the area around the log set clean and clear of debris.
- Occasionally, you may use a soft bristle brush to clean logs.
- Once every year a qualified agency or certified chimney sweep should examine and clean the venting system of the fireplace.

SERVICE HINTS

When Gas Pressure is Too Low

- pilot will not stay lit
- burners will have delayed ignition
- appliance will not produce specified heat

You may feel your gas pressure is too low. If so, contact your local natural gas supplier.

TECHNICAL SERVICE

You may have further questions about installation, operation, or troubleshooting. If so, contact DESA's Technical Service Department at 1-866-672-6040. When calling please have your model and serial numbers of your appliance ready.

You can also visit DESA's technical services web site at www.desatech.com.

REPLACEMENT PARTS

Note: Use only original replacement parts. This will protect your warranty coverage for parts replaced under warranty.

PARTS UNDER WARRANTY

Contact authorized dealers of this product. If they can't supply original replacement part(s), call DESA's Technical Service Department at 1-866-672-6040. When calling DESA, have ready:

- your name and address
- model and serial numbers of your log set
- how log set was malfunctioning
- type of gas used (natural gas)
- purchase date

Usually, we will ask you to return the part to the factory.

PARTS NOT UNDER WARRANTY

Contact authorized dealers of this product. If they can't supply original replacement part(s), call DESA at 1-866-672-6040 for referral information. When calling DESA, have ready

- model number of your log set
- the replacement part number

TROUBLESHOOTING

⚠ WARNING: Turn off log set and let cool before servicing. Only a qualified service person should service and repair log set.

Note: All troubleshooting items are listed in order of operation.

OBSERVED PROBLEM	POSSIBLE CAUSE	REMEDY
Log set is smoking/sooting excessively (<i>Note:</i> It is natural and unavoidable for vented gas log sets to produce moderate levels of carbon (soot) where flames contact the logs.	<ol style="list-style-type: none"> 1. Poor fuel quality 2. Fireplace venting system not drafting properly 3. Excessive flame impingement or blockage 4. Improper fuel/air mixture 5. Excessive gas supply/pressure 	<ol style="list-style-type: none"> 1. Contact local natural or propane/LP gas company 2. Adjust damper wide open and/or have fireplace and venting professionally cleaned and checked 3. Separate the logs to allow more flame passage 4. Remove any foreign items from the flame pattern and/or check for proper orifice sizing 5. Preheat flue in very cold weather
Burner is excessively noisy (<i>Note:</i> The movement and combustion of gas will create low, unavoidable levels of noise.)	<ol style="list-style-type: none"> 1. Passage of air/gas across irregular surfaces 	<ol style="list-style-type: none"> 1. Relieve any tight bends or kinks in gas supply line
Burner flame is too low or too high	<ol style="list-style-type: none"> 1. Incorrect gas supply or pressure 2. Blocked burner orifice or burner manifold ports 3. Improper burner orifice size 	<ol style="list-style-type: none"> 1. Check for proper gas supply pressure 2. Free burner orifice and manifold ports of any burrs, paint, or other blockage 3. Verify proper burner orifice sizing (see Figure 2, page 6)
When ignitor button is pressed, there is no spark at pilot (GA9050A Only)	<ol style="list-style-type: none"> 1. Ignitor electrode not connected to ignitor cable 2. Ignitor cable pinched or wet 3. Bad ground on piezo ignitor 4. Broken ignitor cable 5. Bad piezo ignitor 6. Ignitor electrode broken 7. Ignitor electrode positioned wrong 	<ol style="list-style-type: none"> 1. Reconnect ignitor cable 2. Free ignitor cable if pinched by any metal or tubing. Keep ignitor cable dry 3. Scrape away paint on bracket for better contact with ground on piezo ignitor 4. Replace ignitor cable 5. Replace piezo ignitor 6. Replace electrode 7. Reposition electrode

TROUBLESHOOTING

Continued

OBSERVED PROBLEM	POSSIBLE CAUSE	REMEDY
When ignitor button is pressed, there is spark at pilot but no ignition (GA9050A Only)	<ol style="list-style-type: none">1. Gas supply turned off or equipment shutoff valve closed2. Control knob not in PILOT position3. Control knob not pressed in while in PILOT position4. Air in gas lines when installed5. Pilot adjustment screw closed6. Pilot is clogged7. Low gas pressure	<ol style="list-style-type: none">1. Turn on gas supply or open equipment shutoff valve2. Turn control knob to PILOT position3. Press in control knob while in PILOT position4. Continue holding down control knob. Repeat igniting operation until air is removed5. Adjust pilot flame for approximately 2" blue flame6. Clean pilot (see <i>Cleaning and Maintenance</i>, page 12) or replace pilot assembly7. Replace gas control
Pilot lights but flame goes out when control knob is released (GA9050A Only)	<ol style="list-style-type: none">1. Control knob not fully pressed in2. Control knob not pressed in long enough3. Equipment shutoff valve not fully open4. Pilot flame not touching thermocouple, which allows thermocouple to cool, causing pilot flame to go out. This problem could be caused by one or both of the following: A) Low gas pressure B) Dirty or partially clogged pilot5. Thermocouple connection loose at control valve6. Thermocouple damaged7. Control valve damaged	<ol style="list-style-type: none">1. Press in control knob fully2. After pilot lights, keep control knob pressed in 30 seconds3. Fully open equipment shutoff valve4. A) Contact local natural gas company B) Clean pilot (see <i>Cleaning and Maintenance</i>, page 12) or replace pilot assembly5. Hand tighten until snug, then tighten 1/4 turn more6. Replace thermocouple7. Replace control valve
Burner does not light after pilot is lit (GA9050A Only)	<ol style="list-style-type: none">1. Burner orifice clogged2. Inlet gas pressure is too low3. Thermocouple leads disconnected or improperly connected	<ol style="list-style-type: none">1. Clean burner orifice2. Contact local natural gas company3. Reconnect leads
Delayed ignition burner (GA9050A Only)	<ol style="list-style-type: none">1. Pilot flame needs adjusting2. Wrong pilot orifice	<ol style="list-style-type: none">1. Adjust pilot flame for approximately 2" blue flame2. Replace pilot orifice set

TROUBLESHOOTING

Continued



WARNING: If you smell gas

- Shut off gas supply.
- Do not try to light any appliance.
- Do not touch any electrical switch; do not use any phone in your building.
- Immediately call your gas supplier from a neighbor's phone. Follow the gas supplier's instructions.
- If you cannot reach your gas supplier, call the fire department.

IMPORTANT: Operating log set where impurities in air exist may create odors. Cleaning supplies, paint, paint remover, cigarette smoke, cements and glues, new carpet or textiles, etc., create fumes. These fumes may mix with combustion air and create odors. These odors will disappear over time.

OBSERVED PROBLEM	POSSIBLE CAUSE	REMEDY
Log Set produces a clicking/ticking noise just after burner is lit or shut off	1. Metal expanding while heating or contracting while cooling	1. This is common with most log sets. If noise is excessive, contact qualified service person
Log Set produces unwanted odors	1. Log Set burning vapors from paint, hair spray, glues, cleaners, chemicals, new carpet, etc. (See <i>IMPORTANT</i> statement above) 2. Gas leak. See Warning statement at top of page	1. Open flue to maximum. Stop using odor causing products while log set is running 2. Locate and correct all leaks (see <i>Checking Gas Connections</i> , page 7)
Gas odor even when control knob is in OFF position	1. Gas leak. See Warning statement at top of page 2. Control valve defective	1. Locate and correct all leaks (see <i>Checking Gas Connections</i> , page 7) 2. Replace control valve
Gas odor during combustion	1. Gas leak. See Warning statement at top of page	1. Locate and correct all leaks (see <i>Checking Gas Connections</i> , page 7)

ILLUSTRATED PARTS BREAKDOWN

MODELS LCF18 AND LCF24

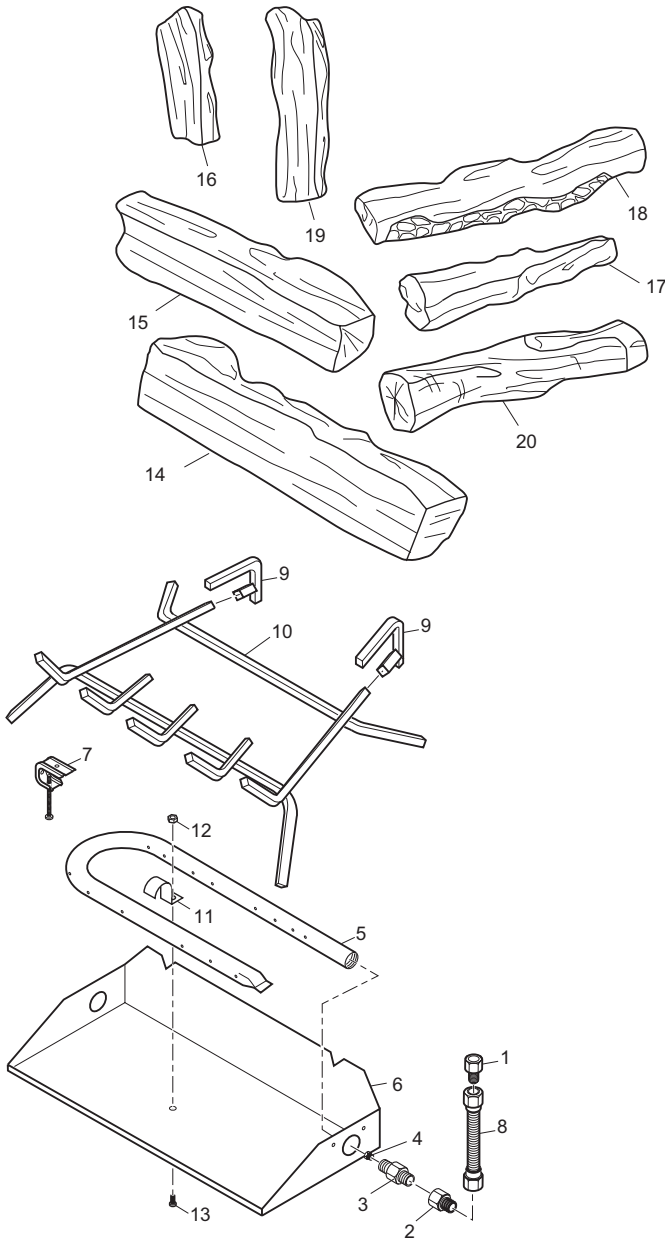

PARTS LIST

This list contains replaceable parts used in your log set. When ordering parts, follow the instructions listed under *Replacement Parts* on page 12 of this manual.

KEY NO.	PART NUMBER		DESCRIPTION	QTY.
	LCF18	LCF24		
1	901056-01	901056-01	3/8 FLR x 1/2 FPT Adapter	1
2	901059-01	901059-01	3/8 FLR x 3/8 FPT Adapter	1
3	901066-01	901066-01	Brass Air Mixer - Natural Gas	1
4	901064-02	901064-03	Natural Gas Injector	1
5	901207-01	901207-01	Burner Manifold	1
6	901137-01	901137-02	Burner Pan	1
7	901242-01	901242-01	Damper Clamp - Std. Assy	1
8	101628-01	101628-01	Gas Line - 10" Flex	1
9	901431-01	901431-01	Grate Steps	2
10	901246-01	901246-02	Log Grate	1
11	901681-01	901681-01	Burner Strap	1
12	901078-01	901078-01	Nut #8/32	1
13	901076-01	901076-01	Screw #8/32 x 3/8	1
14	115049-01	115052-01	Front Bottom Log	1
15	901111-01	901111-02	Rear Bottom Log	1
16	115050-01	115050-01	Top Log	1
17	115051-01	115051-01	Top Log	1
18	901090-01	901090-01	Top Log	1
19	901126-01	901126-01	Top Log	1
20	—	901094-01	Top Log	1
PARTS AVAILABLE — NOT SHOWN				
	901156-01	901156-01	.125# Bag Embers	1
	901155-01	901155-01	1.5# Bag Ash Bed Material (Vermiculite)	1

ACCESSORIES

Purchase these log set accessories from your local dealer. If they can not supply these accessories, call DESA at 1-866-672-6040 for referral information. You can also write to the address listed on the back page of this manual.

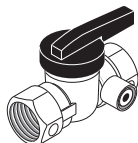

EQUIPMENT SHUTOFF VALVE GA5010

For all models. Equipment shutoff valve with 1/8" NPT tap. Fits 1/2" NPT pipe.

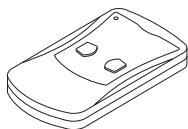

RECEIVER AND HAND-HELD ON/OFF REMOTE CONTROL KIT HRC101

For all models. Allows the gas log set to be turned on and off by using the hand-held remote control. A wall mounted docking station is included. Valve/Pilot Kit GA9150A must be purchased to use this remote.

WALL-MOUNT ON/OFF SWITCH GWMS2 (Not Shown)

For all models. Allows the gas log set to be turned on and off with a wall switch. Valve/Pilot Kit GA9150A must be purchased to use this remote.

MANUAL CONTROL ON/OFF SAFETY VALVE/PILOT KIT - GA9050A (Not Shown)

For all models. Contains components for propane/LP conversion.

REMOTE CONTROL READY ON/ OFF SAFETY VALVE/PILOT KIT GA9150A (Not Shown)

For all models. Required for remote control operation. Contains components for propane/LP conversion.

INDIVIDUAL ROUND LOG - GA9450A (Not Shown)

For decorative purposes only. Not to be used as additional logs on unit.

INDIVIDUAL SPLIT LOG - GA9550A (Not Shown)

For decorative purposes only. Not to be used as additional logs on unit.

PINE CONES - GA9650A (Not Shown)

For all models. Use for additional decoration only. (3 pine cones per box).

ASH BED MATERIAL VERMICULITE) GA9750A (Not Shown)

For all models. Use for firebox decoration only.

GLOWING EMBERS - GA9950A (Not Shown)

For all models. Use for firebox decoration only.

SILICA SAND - GA9850A (Not Shown)

For all models. Use for firebox decoration only.

LAVA ROCK - GA6067A (Not Shown)

For all models. Use for firebox decoration only.

DECORATIVE ASH BED CONTROL COVER - CDABKA (Not Shown)

An attractive way to cover control knob and piezo ignitor.

18" ORNAMENTAL GRATE ENHANCER - GA9350A (Not Shown)

For 18" models only. Additional decoration for front grate.

24" ORNAMENTAL GRATE ENHANCER - GA9360A (Not Shown)

For 24" models only. Additional decoration for front grate.

FIRE CRACKLE - CF6-A (Not Shown)

For all models. Creates the sound of a real burning fire.

WARRANTY INFORMATION

KEEP THIS WARRANTY

Model _____
Serial No. _____
Date Purchased _____

Always specify model and serial numbers when communicating with the factory.

We reserve the right to amend these specifications at any time without notice. The only warranty applicable is our standard written warranty. We make no other warranty, expressed or implied.

LIMITED WARRANTY - VENTED GAS LOGS

DESA warrants this product to be free from defects in materials and components of the burner system for two (2) years and a lifetime on logs from the date of first purchase, provided that the product has been properly installed, operated and maintained in accordance with all applicable instructions. To make a claim under this warranty the Bill of Sale or cancelled check must be presented.

This warranty is extended only to the original retail purchaser. This warranty covers the cost of part(s) required to restore this log set to proper operating condition and an allowance for labor when provided by a DESA Authorized Service Center. Warranty part(s) MUST be obtained through authorized dealers of this product and/or DESA who will provide original factory replacement parts. Failure to use original factory replacement parts voids this warranty. The log set MUST be installed by a qualified installer in accordance with all local codes and instructions furnished with the unit.

This warranty does not apply to parts that are not in original condition because of normal wear and tear, or parts that fail or become damaged as a result of misuse, accidents, lack of proper maintenance or defects caused by improper installation. Travel, diagnostic cost, labor, transportation and any and all such other costs related to repairing a defective log set will be the responsibility of the owner.

TO THE FULL EXTENT ALLOWED BY THE LAW OF THE JURISDICTION THAT GOVERNS THE SALE OF THE PRODUCT, THIS EXPRESS WARRANTY EXCLUDES ANY AND ALL OTHER EXPRESSED WARRANTIES AND LIMITS THE DURATION OF ANY AND ALL IMPLIED WARRANTIES, INCLUDING WARRANTIES OF MERCHANTABILITY AND FITNESS FOR A PARTICULAR PURPOSE TO FOUR (4) YEARS ON burner system and a lifetime on logs FROM THE DATE OF FIRST PURCHASE; AND DESA'S LIABILITY IS HEREBY LIMITED TO THE PURCHASE PRICE OF THE PRODUCT AND DESA SHALL NOT BE LIABLE FOR ANY OTHER DAMAGES WHATSOEVER INCLUDING INDIRECT, INCIDENTAL OR CONSEQUENTIAL DAMAGES.

Some states do not allow a limitation on how long an implied warranty lasts or an exclusion or limitation of incidental or consequential damages, so the above limitation on implied warranties, or exclusion or limitation on damages may not apply to you.

This warranty gives you specific legal rights, and you may also have other rights that vary from state to state.

For information about this warranty write:

DESA[™]

2701 Industrial Drive
P.O. Box 90004
Bowling Green, KY 42102-9004
www.desatech.com



115043 01
NOT A UPC

115043-01
Rev. C
06/05

Free Manuals Download Website

<http://myh66.com>

<http://usermanuals.us>

<http://www.somanuals.com>

<http://www.4manuals.cc>

<http://www.manual-lib.com>

<http://www.404manual.com>

<http://www.luxmanual.com>

<http://aubethermostatmanual.com>

Golf course search by state

<http://golfingnear.com>

Email search by domain

<http://emailbydomain.com>

Auto manuals search

<http://auto.somanuals.com>

TV manuals search

<http://tv.somanuals.com>