

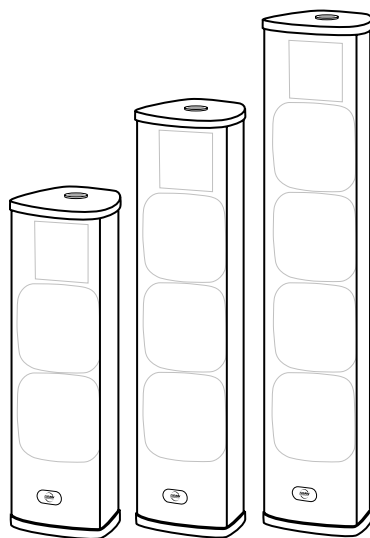

CLA6 CLA4 CLA2

Column Loudspeakers



INSTRUCTION MANUAL

1. SAFETY INSTRUCTIONS

1. Read Instructions
2. Keep these Instructions
3. Heed all Warnings
4. Follow all Instructions
5. Do not use this apparatus near water.
6. Clean only with a dry cloth.
7. Do not block any ventilation openings. Install in accordance with the manufacturer's instructions.
8. Do not install near any heat sources such as radiators, heat registers, stoves, or other apparatus (including amplifiers) that produce heat.
9. Only use attachments/accessories specified by the manufacturer.
10. Refer all servicing to qualified service personnel. Servicing is required when the apparatus has been damaged in any way, such as liquid has been spilled or objects have fallen into the apparatus, the apparatus has been exposed to rain or moisture, does not operate normally, or has been dropped.
11. The entire sound system must be designed in compliance with the current standards and laws regarding electrical systems.
12. When installing and using this apparatus, keep in mind the technical specifications indicated in the dedicated section of the manual.
13. Exposure to high sound levels can cause permanent hearing loss. The sound pressure level which leads to hearing loss varies considerably from one person to another, and depends on the duration of exposure. The U.S. Government's Occupational Safety and Health Administration (OSHA) has established the maximum sound pressure levels that can be with stood without causing damage, which are shown in the table below. According to the OSHA regulations, any exposure over the maximum limits indicated in the table can reduce the hearing capacity of a person. To prevent potentially dangerous exposure to high sound pressure levels, anyone subjected to such levels must use suitable protection. When a EAW Commercial product capable of producing high sound levels is being used, it is therefore necessary to wear ear plugs or protective earphones when the limits shown in the table are exceeded. Consult the specifications provided in the instruction manual to know the maximum sound pressure (SPL) the loudspeaker is capable of producing.

CAUTION AVIS



RISK OF ELECTRIC SHOCK • DO NOT OPEN
RISQUE DE CHOC ELECTRIQUE
NE PAS OUVRIR



CAUTION: TO REDUCE THE RISK OF ELECTRIC SHOCK
DO NOT REMOVE COVER (OR BACK)
NO USER-SERVICEABLE PARTS INSIDE
REFER SERVICING TO QUALIFIED PERSONNEL.

ATTENTION: POUR EVITER LES RISQUES DE CHOC ELECTRIQUE, NE PAS ENLEVER LE COUVERCLE. AUCUN ENTRETIEN DE PIECES INTERIEURES PAR L'USAGER. CONFIER L'ENTRETIEN AU PERSONNEL QUALIFIE.

AVIS: POUR EVITER LES RISQUES D'INCENDIE OU D'ELECTROCUTION, N'EXPOSEZ PAS CET ARTICLE A LA PLUIE OU A L'HUMIDITE



The lightning flash with arrowhead symbol within an equilateral triangle is intended to alert the user to the presence of uninsulated "dangerous voltage" within the product's enclosure, that may be of sufficient magnitude to constitute a risk of electric shock to persons.

Le symbole éclair avec point de flèche à l'intérieur d'un triangle équilatéral est utilisé pour alerter l'utilisateur de la présence à l'intérieur du coffret de "voltage dangereux" non isolé d'ampère suffisante pour constituer un risque d'électrocution.



The exclamation point within an equilateral triangle is intended to alert the user of the presence of important operating and maintenance (servicing) instructions in the literature accompanying the appliance.

Le point d'exclamation à l'intérieur d'un triangle équilatéral est employé pour alerter les utilisateurs de la présence d'instructions importantes pour le fonctionnement et l'entretien (service) dans le livret d'instruction accompagnant l'appareil.

WARNING! *This equipment has been designed to be installed by qualified professionals only! There are many factors to be considered when installing professional sound reinforcement systems, including mechanical and electrical considerations, as well as acoustic coverage and performance. EAW Commercial strongly recommends that this equipment be installed only by a professional sound installer or contractor.*

Duration per day (hours)	Sound level (dBA)	Typical example
8	90	Duo in a small club
6	92	
4	95	Subway train
3	97	
2	100	Very loud classical music
1.5	102	
1	105	Locomotive at 50 feet
0.5	110	
0.25 or less	115	Loudest parts at a rock concert

Part No. 0010153 Rev. A 05/2004
 © 2004 LOUD Technologies Inc. All Rights Reserved.



TABLE OF CONTENTS

1. SAFETY INSTRUCTIONS	2
2. INTRODUCTION	3
3. INSTALLATION	4
4. CONNECTIONS	5
5. SPECIFICATIONS	6
6. SERVICE INFORMATION	7
7. WARRANTY	7

2. INTRODUCTION

This manual describes the CLA series of column loudspeakers (CLA2, CLA4 and CLA6). These compact loudspeakers offer an attractive design and good acoustic features for quality speech and music reproduction.

The extended-range drivers guarantee high efficiency, and a wide angle of coverage over the entire range reproduced. Each loudspeaker is equipped with an internal line transformer that makes it possible to connect it to constant voltage sound systems at 70 V or 100 V.

An easily accessible rotary switch allows you to select a range of five output power values. A low cut switch is provided for reducing the level of the frequency range below 400 Hz for clear speech reproduction.

The galvanized steel body and metal grill are very sturdy, and the white color allows the CLA series to be easily integrated into any environment. The shape of the back of the body allows positioning in corners, and the light weight makes it possible to install them in false ceilings. Two L-type brackets are included.

Applications include:

- Houses of Worship
- Museums
- Theme Parks
- Transportation Terminals
- Retail Spaces
- Commercial Offices
- Conference Rooms
- Schools
- Distributed Systems

3. INSTALLATION

The two support brackets provided can be used for installing the sound column on the wall or ceiling. Use the supplied bolts, plain washers and split lock washers to bolt the brackets to the loudspeakers.

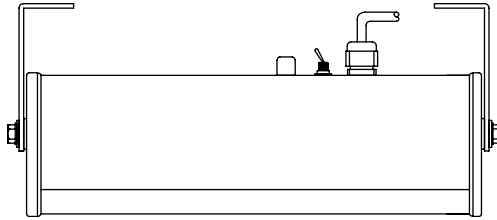

WARNING: Make sure that the loudspeaker is installed in a stable and secure way in order to avoid any conditions that may be dangerous for persons or structures:

- Check to make sure that the support surface (e.g., wall, etc.) has the necessary mechanical characteristics to support the weight of the loudspeaker without the danger of it falling.
- Always use support elements suitable for the material of the wall that will support the loudspeaker (e.g., screw anchors for bricks, screw anchors for cement, etc.).
- Before suspending the loudspeaker, carefully check all the components to be used to make sure there is no damage, deformation, corrosion and/or missing or damaged parts that could reduce the safety of the installation.
- Consult a professional rigger or structural engineer prior to suspending loudspeakers from a structure not intended for that use. Always know the working load limit of the structure supporting the loudspeaker. Always make sure that the rigging hardware minimum rating is at least five times the actual load.

Installation precautions

- Use speaker cables with an adequate cross-section (gauge). The greater the distance between the amplifier and loudspeaker, the larger the connection cable cross-section should be.
- To prevent inductive phenomena causing humming or distortion, the speaker cables should not be run together with electrical energy conductors, microphone cables, or line-level audio lines. Use speaker cables that have markings to distinguish the polarity, such as insulation or conductors of different colors.
- Avoid installing the loudspeaker in places exposed to harsh weather conditions.

4. CONNECTIONS



WARNING: To prevent the risk of electric shock, do not connect the loudspeaker or adjust the power selector with the amplifier switched on.

The loudspeaker is designed to be connected to constant-voltage audio lines at 70 V or 100 V.

1. The white wire of the loudspeaker connects to the positive amplifier output, the black loudspeaker wire connects to the negative amplifier output.
2. Use a suitable tool to crimp the two supplied wires to the ends of your audio line conductors. Insulate the joints.
3. Using a small flat screwdriver, rotate the power selector to the desired setting. The specifications section on the next page shows the power settings for the three CLA loudspeakers.
4. If your system does not need to reproduce low frequencies, set the 400 Hz Low Cut switch to the ON position. This will reduce the output levels of the frequency range below 400 Hz.

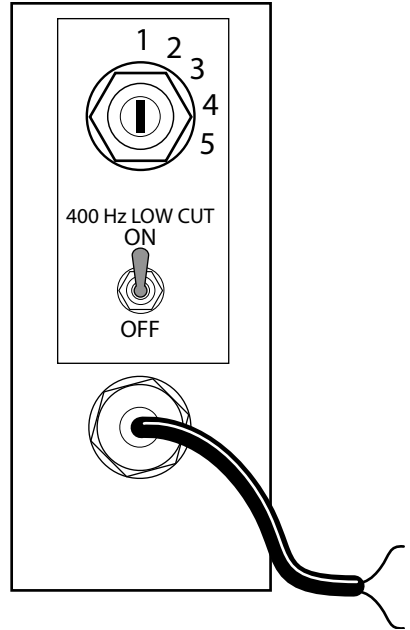

Precautions

- Before using the loudspeaker, carefully check that all the connections have been made correctly to make sure there are no accidental short circuits that could cause electrical sparks.
- Check if your power amplifier's constant output voltage is 70 V or 100 V, and find the rated power output.
- The sum of the operating power values of all the loudspeakers connected to the audio line must not exceed 80 % of the amplifier's output power.
- Verify that the connections to all of your loudspeakers are made correctly "in phase." When different loudspeakers reproduce the same frequencies but with phase differences, there may be sound cancellation. Loudspeakers are often situated in adjacent positions and the sound waves interact with each other. If a loudspeaker is connected incorrectly; i.e., the polarity of the audio line conductors is inverted, the audio signals are transmitted with differences in phase and correct reproduction is therefore jeopardized. Most notably, the bass response may suffer.

5. SPECIFICATIONS

Model	CLA2	CLA4	CLA6
Rated Power	20 W	30 W	40 W
Woofers	3" x 2	3" x 3	3" x 4
Tweeter	2" x 1	2" x 1	2" x 1
SPL (1 W/m)	87 dB	88 dB	90 dB
Max SPL (20 W/m)	100 dB	103 dB	106 dB
Freq Range (-10 dB)	150 Hz-20 kHz	140 Hz-20 kHz	140 Hz-20 kHz
Horizontal Dispersion (1 kHz/4 kHz)	190°/120°	195°/105°	205°/140°
Low Cut	400 Hz	400 Hz	400 Hz
Vertical Dispersion (1 kHz/4 kHz)	125°/30°	105°/30°	85°/45°
Length	11.97"/304 mm	15.24"/387 mm	18.46"/469 mm
Depth	3.74"/95 mm	3.74"/95 mm	3.74"/95 mm
Width	3.7"/94 mm	3.7"/94 mm	3.7"/94 mm
Weight	3.97 lbs/1.8 kg	5.07 lbs/2.3 kg	6.39 lbs/2.9 kg
Mounting supplied	2 L-brackets	2 L-brackets	2 L-brackets

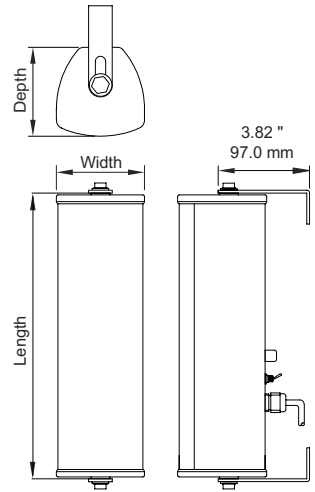

Power Selector

CLA2

Switch Position	70 V Power (W)	100 V Power (W)	Impedance
1	20	Do not use	250 Ω
2	10	20	500 Ω
3	5	10	1 kΩ
4	2.5	5	2 kΩ
5	1.25	2.5	4 kΩ

CLA4

Switch Position	70 V Power (W)	100 V Power (W)	Impedance
1	30	Do not use	167 Ω
2	15	30	333 Ω
3	7.5	15	666 Ω
4	3.75	7.5	1.33 kΩ
5	1.9	3.75	2.67 kΩ

CLA6

Switch Position	70 V Power (W)	100 V Power (W)	Impedance
1	40	Do not use	125 Ω
2	20	40	250 Ω
3	10	20	500 Ω
4	5	10	1 kΩ
5	2.5	5	2 kΩ

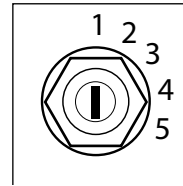

Disclaimer

EAW Commercial continually engages in research related to product improvement, new materials, and production methods. Design refinements are introduced into existing products without notice as a routine expression of that philosophy. For this reason, any current EAW Commercial product may differ in some respect from its published description, but will always equal or exceed the original design specifications unless otherwise stated.

“EAW Commercial” is a trademark of LOUD Technologies Inc.

All other brand names mentioned are trademarks or registered trademarks of their respective holders, and are hereby acknowledged.

6. SERVICE INFORMATION

In the event that your CLA loudspeaker should require servicing, please follow these instructions:

1. Call EAW Commercial Tech Support at 1-888-337-7404, 7 am to 5 pm PST (Monday-Friday), to verify the problem and obtain a Return Authorization (RA) Number. Be sure to have the serial number of the unit when you call. You must have a Return Authorization Number in order to obtain warranty service at the factory or at an authorized service center. You can also email EAW Commercial Tech Support at: support@eawcommercial.com
2. Pack the unit in its original packaging. THIS IS VERY IMPORTANT. LOUD Technologies is not responsible for any damage that occurs during shipping due to non-conventional packaging. Original packaging helps to minimize the possibility of shipping damage.
3. Include a legible note stating your name, (no P.O. boxes), daytime phone number, Return Authorization Number, and a detailed description of the problem, including how we can duplicate it.
4. Write the Return Authorization Number in **BIG BOLD PRINT** on top of the box.
5. Tech Support will tell you where to ship the unit when you call for an RA Number. We suggest insurance for all forms of cartage.

7. WARRANTY

Warranty: LOUD Technologies Inc. requires its authorized EAW Commercial distributors abide by the following warranty terms for all EAW Commercial brand products (all dates are from the date of delivery from an Authorized EAW Commercial Distributor to the end user/installation site):

Loudspeakers – 5 years; Active Electronics – 5 years; Accessories – 2 years.

What Is Covered: Defects in workmanship and materials and against malfunctions. EAW Commercial distributors must remedy all such defects and malfunctions without charge for parts or labor if the warranty applies. Final determination of warranty coverage lies solely with each authorized EAW Commercial distributor.

What Is Not Covered: This warranty does not extend to damage or malfunctions resulting from, but not limited to, shipment, improper installation, misuse, neglect, abuse, normal wear, accident, or to any product on which the serial number has been modified or removed. Exterior defects in or damage to the exterior appearance are specifically excluded from this warranty. EAW Commercial distributors shall not be liable for incidental or consequential damages resulting from the use of EAW Commercial products. Repairs and/or modifications by other than an Authorized EAW Commercial Distributor automatically voids this warranty.



EAW Commercial | One Main Street | Whitinsville, MA 01588 USA

TEL toll free within US/Canada 888.337.7404 | TEL outside US 425.892.6503 | FAX 425.485.1152

www.eawcommercial.com

© 2004 LOUD Technologies Inc. All Rights Reserved. EAW Commercial is a registered trademark of LOUD Technologies Inc.

Download from Www.Somanuals.com. All Manuals Search And Download.

Free Manuals Download Website

<http://myh66.com>

<http://usermanuals.us>

<http://www.somanuals.com>

<http://www.4manuals.cc>

<http://www.manual-lib.com>

<http://www.404manual.com>

<http://www.luxmanual.com>

<http://aubethermostatmanual.com>

Golf course search by state

<http://golfingnear.com>

Email search by domain

<http://emailbydomain.com>

Auto manuals search

<http://auto.somanuals.com>

TV manuals search

<http://tv.somanuals.com>