

DHT7100

DIGITAL HOME THEATER SYSTEM

- DVD, CD, VCD and MP3-CD playback
- AM/FM Stereo Receiver
- Five Wall-Mountable Speakers plus Subwoofer
- Built-in 270W Amplifier
- Built-in Dolby Digital 5.1 Decoder
- Dolby Digital 5.1 and DTS Digital Out
- English, French and Spanish
On-Screen Menus

SSC.7100.091101

GO.VIDEO®



CONGRATULATIONS...

...on your purchase of this Go-Video DVD Home Theater System!

We know you will enjoy this product for many years to come. In case warranty service is required, please take a moment to attach your receipt to this manual and write down your Serial Number (located on the back panel of the DVD system):

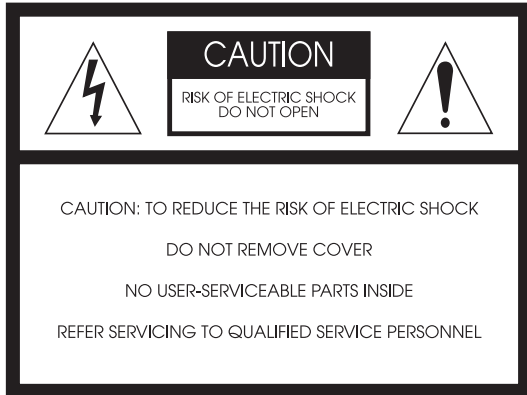

DANGER

This symbol is intended to alert the user to the presence of uninsulated dangerous voltage within the product's enclosure that may be of sufficient magnitude to constitute risk of fire or electric shock.



WARNING

This symbol is intended to alert the user to the presence of important operating and maintenance instructions in the literature accompanying this product.

WARNING:

To reduce the risk of fire or electric shock, do not expose this appliance to rain or moisture.

CAUTION

TO REDUCE THE RISK OF ELECTRIC SHOCK, DO NOT REMOVE TOP COVER, NO USER SERVICEABLE PARTS INSIDE, REFER SERVICING TO QUALIFIED SERVICE PERSONNEL.

CLASS 1 LASER PRODUCT

This Compact Disc player is classified as a CLASS 1 LASER product.

Use of controls adjustments or performance of procedures other than those specified herein may result in hazardous radiation.

CAUTION

INVISIBLE LASER RADIATION WHEN OPEN AND INTERLOCK DEFEATED. AVOID EXPOSURE TO BEAM.

WARNING:

This unit contains no user serviceable parts. Never remove covers unless qualified to do so. This unit contains dangerous voltages. Always remove main plug from the socket before any service operation and when not in use for a long period.

IMPORTANT:

Do not use this unit for commercial use. This unit is designed for your enjoyment in your home. We cannot be liable for the quality of the unit if you use it for commercial use.

NOTE TO CATV SYSTEM INSTALLER

This reminder is provided to call the CATV system installer's attention to article 820-40 of the NEC provides guidelines for proper the cable ground shall be connected to the grounding system of the building, as close to the point of cable entry as practical.

Go-Video is a registered trademark of Sensory Science Corporation. Manufactured under license from Dolby Laboratories. Dolby, Pro Logic and the double-D symbol are trademarks of Dolby Laboratories Licensing Corp. DTS and DTS Digital Out are trademarks of DTS Technology, LLC. All other brand and product names are trademarks or registered trademarks of their respective companies. © Copyright 2001. Sensory Science Corp. All rights reserved.

TABLE OF CONTENTS

This user's guide is organized to get you started with the DHT7100 as quickly as possible. The first two chapters present all the basics, including connections and the most commonly used features. Chapters 3 and 4 cover special playback and setup features. Chapter 5 contains helpful customer service and troubleshooting info, followed by a visual and topical Index. Enjoy!

SAFETY	iii
1 - GETTING STARTED	1
Welcome	1
Disc Compatibility	1
Step 1 - Unpack	2
Step 2 - Insert Remote Batteries	2
Step 3 - Connect video to TV	2
Step 4 - Place & Connect Speakers	3
Step 5 - Connect Antenna	4
Step 6 - Power On the System	4
Step 7 - Program Remote to Operate TV	5
Step 8 - Optional Connections	6
2 - BASIC OPERATIONS	7
Selecting DVD, Tuner or Aux	7
Basic Disc Playback	8
Disc Menu Navigation	8
Options During Playback	9
Volume Settings	10
Listening to the Radio	10
Programming Station Presets	11
MP3 playback	12
3 - SPECIAL FEATURES	13
Display	13
Go To	14
Title	14
Angle	15
Zoom	15
Subtitle	15
Audio	15
Repeat	16
AB Repeat	16
Program	16
Remain	17
DRC (Dynamic Range Compression)	17
Sleep	18
Pro logic	18
DSP mode	19
Effect	19

4 - ADVANCED SETUP	20
Setting Speaker Sizes	20
Adding Center & Rear Delays	20
Setting Speaker Balance and Levels	21
Calculating Delays	21
Using the Test Tone Generator	21
Setup Menu Navigation	22
Language Preferences	22
TV Screen Size	23
Rating Levels	24
Digital Output Format	24
5 - HELP	25
Troubleshooting	25
Disc Handling Precautions	27
System Maintenance	27
Technical Specifications	28
Warranty	29
INDEX	30
Front Panel Controls	30
Front Panel Display	30
Rear Panel	31
Remote Control (under sliding panel)	31
Remote Control (top section)	32

SAFETY

Before you begin, be sure to read these special safety precautions.

READ INSTRUCTIONS

All the safety and operating instructions should be read before the unit is operated.

RETAIN INSTRUCTIONS

The safety and operating instructions should be retained for future reference.

HEED WARNINGS

All warnings on the unit and in the operating instructions should be adhered to.

FOLLOW INSTRUCTIONS

All operating and maintenance instructions should be followed.

CLEANING

Unplug this video unit from the wall outlet before cleaning. Do not use liquid or aerosol cleaners. Use a dry cloth for dusting cabinet.

ATTACHMENTS

Do not use attachments not recommended by the video product manufacturer, as they may be hazardous.

WATER & MOISTURE

Do not use this video unit near water—for example, near a bathtub, wash bowl, kitchen sink, laundry tub, in a wet basement, near a swimming pool or the like.

ACCESSORIES

Do not place this video unit on an unstable cart, stand, tripod, bracket or table. The video unit may fall, causing serious injury to a child or adult, and serious damage to the unit. Use only with a cart, stand, tripod, bracket or table recommended by the manufacturer or sold with the video unit. Any mounting of the unit should follow the manufacturer's instructions and should use a mounting accessory recommended by the manufacturer.



An appliance and cart combination should be moved with care. Quick stops, excessive force, and uneven surfaces may cause the appliance and cart combination to overturn.

PORTABLE CART WARNING
(Symbol provided by RETAC)

VENTILATION

Slots and openings in the cabinet are provided for ventilation to ensure reliable operation of the video unit and to protect it from overheating. These openings must not be blocked or covered. Never place your DVD system on a bed, sofa, rug or other similar surface, on or near a radiator or heat register. This video unit should not be placed in a built-in installation such as a bookcase or rack unless proper ventilation is provided or the manufacturer's instructions have been adhered to.

POWER SOURCES

This video unit should be operated only from the type of power source indicated on the marking label. If you are not sure of the type of power supply to your home consult your appliance dealer or local power company. For video units intended to be operated from battery power, or other sources, refer to the operating instructions.

GROUNDING OR POLARIZATION

This video unit may be equipped with either a polarized 2-wire AC line plug (a plug having one blade wider than the other) or a 3-wire grounding plug having a third (grounding) pin.

The 2-wire polarized plug will fit into the power outlet only one way. This is a safety feature. If you are unable to insert the plug fully into the outlet try reversing the plug. If the plug still fails to fit, contact your electrician to replace your obsolete outlet. Do not defeat the safety purpose of the polarized plug.

POWER-CORD PROTECTION

Power-supply cords should be routed so that they are not likely to be walked on or pinched by items placed upon or against them, paying particular attention to cords of plugs, convenience receptacles, and the point where they exit from the unit.

OUTDOOR ANTENNA GROUNDING

If an outside antenna or cable system is connected to the video unit, be sure the antenna or cable system is grounded to provide some protection against voltage surges and built-up static charges. Section 810 of the National

Electrical Code, ANSI/NFPA No. 70-1984, provides information with respect to proper grounding of the mast and supporting structure, grounding of the lead-in wire to an antenna discharge unit, size of grounding conductors, location of antenna-discharge unit, connection to grounding electrodes, and requirements for the grounding electrode. See figure below.

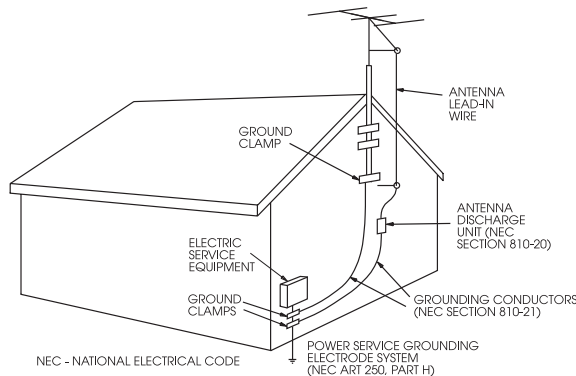

LIGHTNING

For added protection of this video unit during a lightning storm, or when it is left unattended and unused for long periods of time, unplug it from the wall outlet and disconnect the antenna or cable system. This will prevent damage to the video unit due to lightning and power line surges.

POWER LINES

An outside antenna system should not be located in the vicinity of overhead power lines or other electric light or power circuits, where it can fall into such power lines or circuits. When installing an outside antenna system extreme care should be taken to keep from touching such power lines or circuits as contact with them might be fatal.

OVERLOADING

Do not overload wall outlets and extension cords as this can result in the risk of fire or electric shock.

OBJECTS AND LIQUIDS

Never push objects of any kind into this video unit through openings as they may touch dangerous voltage points or short out parts that could result in a fire or electric shock. Never spill liquids of any kind onto the unit. Should

spillage occur, unplug unit and have it checked by a technician before use.

SERVICING

Do not attempt to service this video unit yourself as opening or removing covers may expose you to a dangerous voltage or other hazards. Refer all servicing to qualified service personnel.

DAMAGE REQUIRING SERVICE

Unplug this video unit from the wall outlet and refer servicing to qualified service personnel under the following conditions:

- a When the power supply cord or plug is damaged.
- b If any liquid has been spilled onto or objects have fallen into the video unit.
- c If the video unit has been exposed to rain or water.
- d If the video unit does not operate normally by following the operating instructions. Adjust only those controls that are covered by the operating instructions. Improper adjustment of other controls may result in damage and will often require extensive work by a qualified technician to restore the video unit to its normal operation.
- e If the video unit has been dropped or the cabinet has been damaged.
- f When the video unit exhibits a distinct change in performance—this indicates a need for service.

REPLACEMENT PARTS

When replacement parts are required, be sure the service technician has used replacement parts specified by the manufacturer or those having the same characteristics as the original part. Unauthorized substitutions may result in fire, electric shock or other hazards.

SAFETY CHECK

Upon completion of any service or repairs to this video unit ask the service technician to perform safety checks to determine that the video unit is in safe operating order.

HEAT

This video unit should be situated away from heat sources such as radiators, stoves, or other products (including amplifiers) that produce heat.

1

GETTING STARTED

This Chapter shows you everything you need to set up your DHT7100, from unpacking to connections to powering on the system.

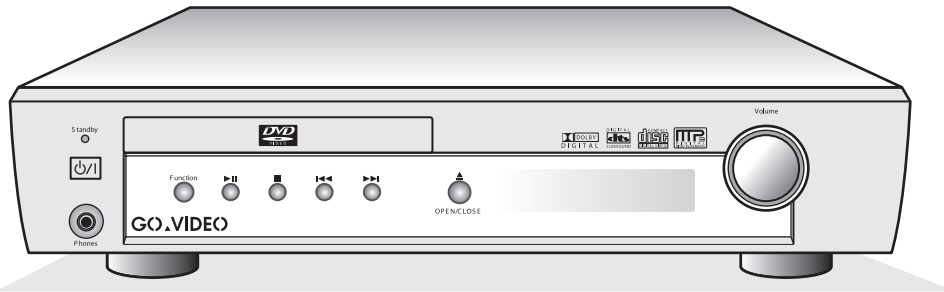

WELCOME

Welcome to the DHT7100, the all-in-one digital home theater system, complete with a DVD player, AM/FM receiver and built-in amplifier! Now you can enjoy all your favorite home entertainment media in one integrated package, including:

- DVD movies in Dolby Digital 5.1 surround sound
- Audio and Video CDs
- MP3 audio files burned on CD-R/CD-RW
- Plus all your favorite AM/FM radio stations!

DISC COMPATIBILITY

The DHT7100 can play discs with the following logos:

- DVD (Digital Versatile Disc) Video
- CD Audio
- Video-CD
- Region 1
- Dolby Digital
- DTS (Digital Theater Sound)
- MP3
- CD-R/CD-RW

Not supported: LD, CD-ROM, DVD-ROM



NOTE

- DVD players and discs are coded by region. This DVD player is coded Region 1, which includes the U.S., U.S. territories and Canada. If a disc is not coded for Region 1, it will not play.

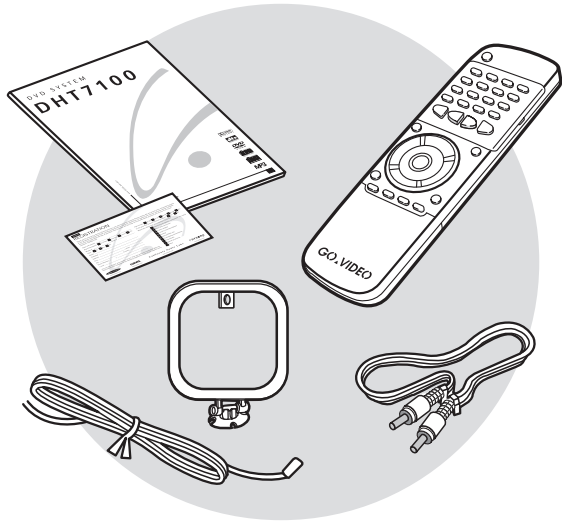

STEP 1 - UNPACK

Before you begin, make sure the following accessories are included in your DHT7100 packing case:

- Remote Control
- AM Loop Antenna
- FM Antenna
- Video cable
- User's Guide
- Warranty Card

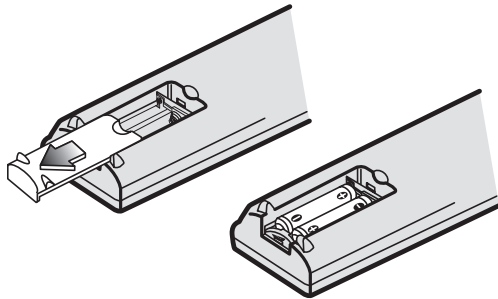

Insert two 1.5V AAA batteries.

STEP 2 - INSERT REMOTE BATTERIES

1. Remove the battery cover on the back of the remote by pressing down and sliding the cover in the direction of the arrow.
2. Insert two 1.5V AAA batteries, paying attention to the correct polarities (+ and -).
3. Replace the battery cover.

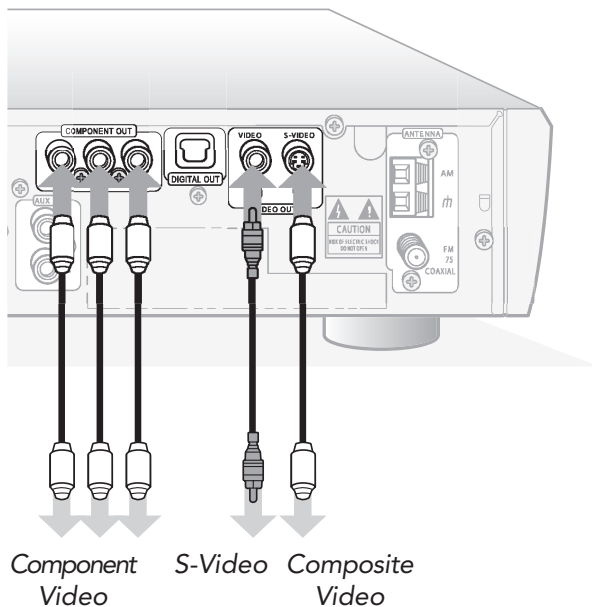

STEP 3 - CONNECT VIDEO TO TV

Composite Video (Good Quality)

Connect the supplied video cable from the VIDEO OUT jack on the back panel of the system to the VIDEO IN jack on your television.

S-Video (Better Quality)

If your television is equipped with an S-Video input, connect an S-Video cable (not supplied) from the S-VIDEO OUT jack on the back panel of the system to the S-VIDEO IN jack on your television.

Component Video (Best Quality)

If your television is equipped with Component Video inputs, connect a component video cable (not supplied) from the Pr, Pb and Y jacks on the back panel of the system to the corresponding jacks on your television.

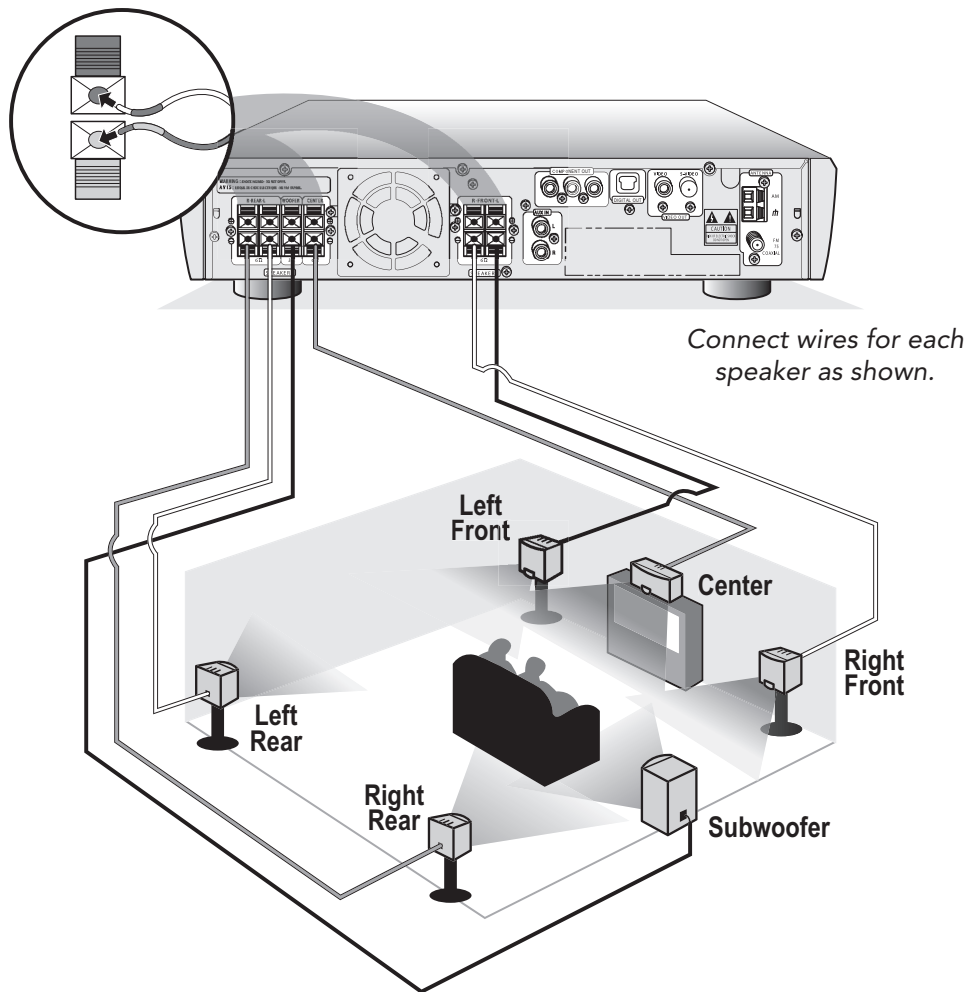

STEP 4 - PLACE & CONNECT SPEAKERS

Speaker Placement

Arrange the 6 speakers as shown in your listening area.

- **Front Speakers** (16' cables) - Set the front speakers so that they are aligned at ear level and at a horizontal angle of 45 degrees to the primary listening area.
- **Rear Speakers** (32' cables) - Set the surround speakers further back, parallel to the walls, at 2 to 3 feet above the ear level of the primary listening area. If the space behind the listening area is limited (i.e., close to the wall), place the rear speakers facing each other on either side.
- **Center Speaker** (16' cable) - The center speaker should be positioned with its top surface flush with the front speakers. However, you may place the speaker either on top of or next to your TV set.
- **Subwoofer** (15' cable) - Place the subwoofer at any convenient location within the vicinity of the listening area.

Speaker Connections

1. Make sure the power is turned off before connecting the speakers to prevent possible damage to the speakers.
2. Connect each red and black speaker wire to the system's back panel as shown, being careful to connect each speaker to its correctly labeled output.
3. To insert each color-coded wire, press down on the red and black thumb levers and then release them to lock the wires in place.

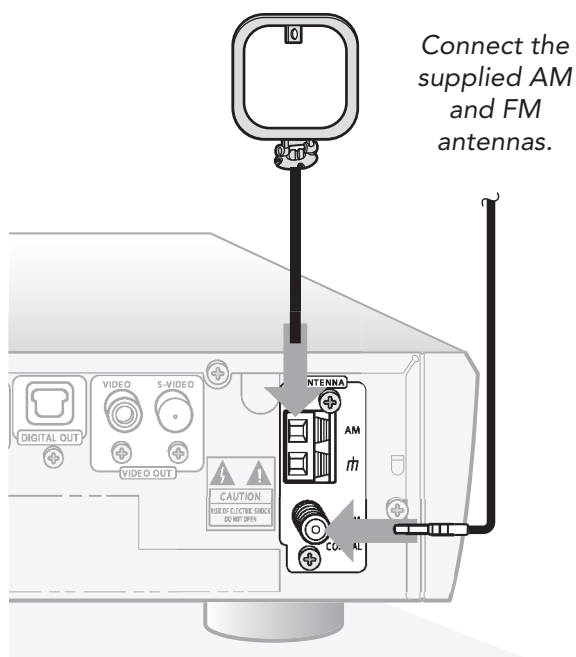

STEP 5 - CONNECT ANTENNA

AM Loop Antenna

1. Complete assembly of the supplied AM loop antenna by rotating the base and snapping it into place.
2. Connect the two wires from the AM loop antenna to the AM ANTENNA connector on the back panel. Press down on the thumb lever to insert each wire, and then release to lock the wires in place.

FM Antenna

Connect the supplied FM antenna to the "FM 75Ω COAXIAL" connector on the back panel. If noise or interference occurs, use an external antenna with a 75Ω coaxial cable (not supplied).

STEP 6 - POWER ON THE SYSTEM

1. Connect the power cord to a standard 120VAC/60Hz electrical outlet.
 - The red Standby LED will glow on the front panel to indicate that the system is plugged in and in Standby mode.
2. Press the POWER ⏻/I button on the front panel or the remote control to power on the unit.

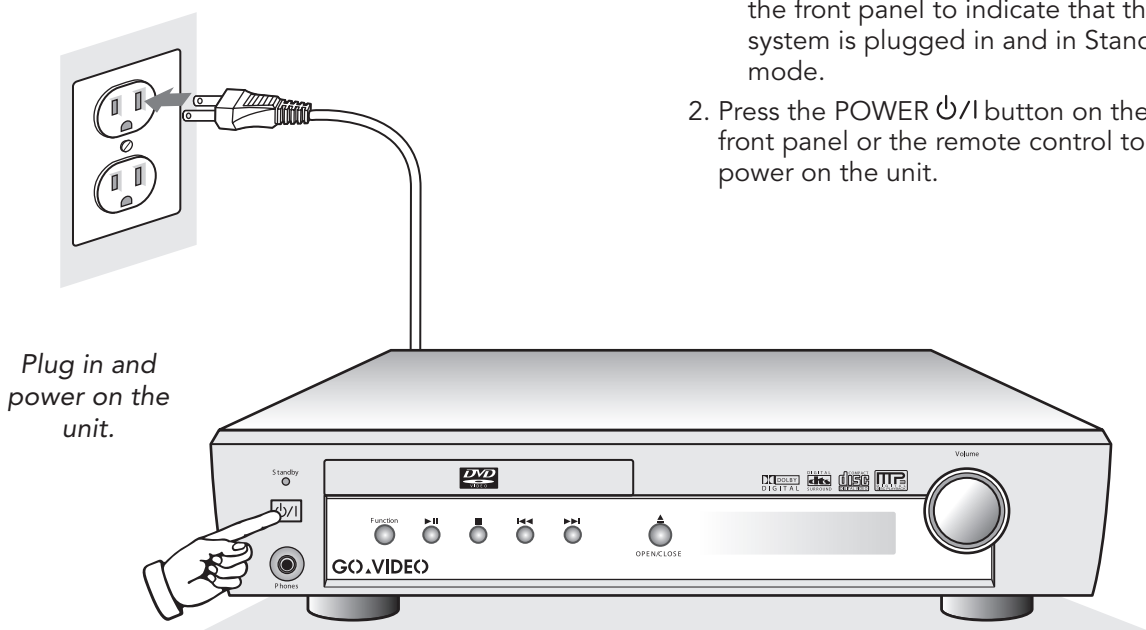

BRAND	TV CODE
Daewoo	19
Emerson	21
Hitachi	10
JVC	11
LG	08, 06, 18
Loewe	28
Magnavox	04
Matsushita	24
Mitsubishi	13
Newsan	27
Noblex	25
Panasonic	12
RCA	07, 29
Samsung	01, 14, 15, 23
Sanyo	05, 20
Sharp	02, 22
Sony	03
Telefunken	26
Toshiba	09
Zenith	17

Locate the TV Code(s) for your brand of television.

STEP 7 - PROGRAM REMOTE TO OPERATE TV

You can program the DHT7100 remote control to operate many brands of television.

1. Find the TV code(s) for your brand of television.
 - If your brand is not listed, you will not be able to program the remote.
2. Point the remote at your television.
3. While holding down the TV POWER ⏻ /I button, press the 2-digit number listed for your brand of television.

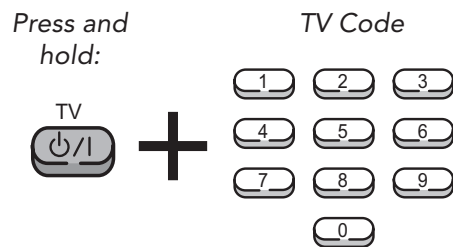

4. If your TV powers on or off, programming is complete.
 - If the TV did not power on or off, try the other codes for your brand until you find one that works.
 - Not all TV models can be programmed.

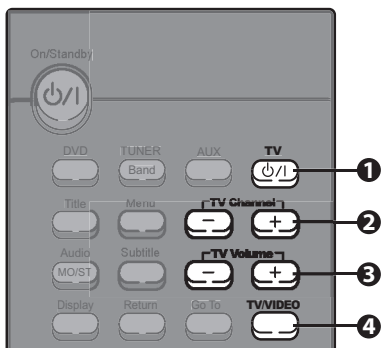

Use these keys to control your television.

TV Control Keys

Once the remote is programmed, use the following keys to control your television:

- 1 Press the TV POWER ⏻ /I button to power your TV on or off.
- 2 Press the TV CHANNEL +/- buttons to select the next or previous channel on your television.
- 3 Press the TV VOLUME +/- buttons to adjust the volume level on your television.
- 4 Press the TV/VIDEO button to select the TV's video input(s).

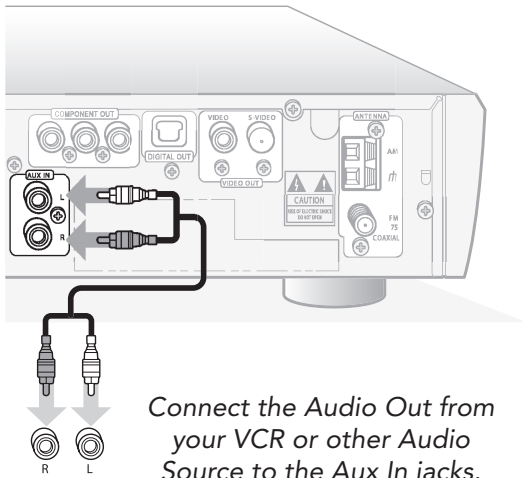

Connect the Audio Out from your VCR or other Audio Source to the Aux In jacks.

STEP 8 - OPTIONAL CONNECTIONS

Connect Aux In

You can connect the audio from your VCR or other audio source to the DHT7100 to enjoy stereo or Dolby Pro Logic surround sound playback through the speakers.

- Connect an RCA stereo audio cable from the Audio Out jacks on your VCR (or other audio source) to the AUX IN jacks on the back panel of the system.

SPECIAL NOTES ON CONNECTING A VCR TO THE DHT7100

1. There is no need to change the video connection you are currently using to connect your VCR to your television. Simply view the VCR in the same manner you currently do.
2. Connect the audio from your VCR to the Aux In jacks on the back panel of the DHT7100 as mentioned above.
3. Press the AUX button on the DHT7100 and turn down the volume on your TV to listen to the audio from your VCR through the speakers.

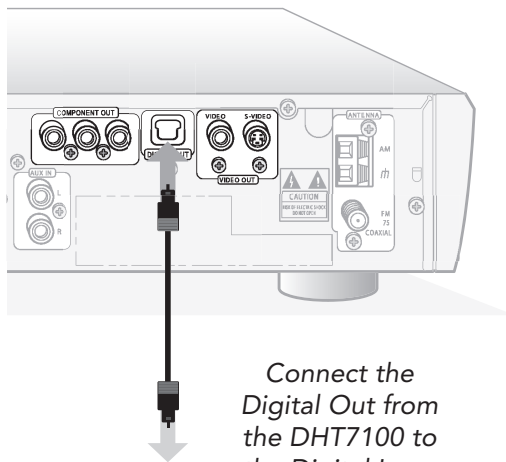

Connect the Digital Out from the DHT7100 to the Digital In on your A/V receiver.

Connect Digital Out

The optical digital output allows you to connect the DHT7100 to an audio/video receiver with a Dolby Digital and/or DTS decoder.

- Connect a digital optical cable from the DIGITAL OUT on the back panel of the DHT7100 to the DIGITAL IN of your A/V receiver.
- See "Digital Output Format" on page 24 to set the format of the digital output for your type of audio/video receiver to bitstream or linear PCM (stereo).

Initial Setup is complete!

Please proceed to Chapter 2 - Basic Operations.

2

BASIC OPERATIONS

This chapter shows you how to use basic features of your DHT7100, such as playing DVDs, navigating disc menus, and using the AM/FM receiver.

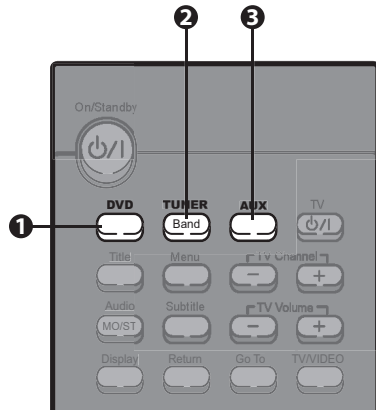

Select DVD, Tuner or Aux.

SELECTING DVD, TUNER OR AUX

The first step in using the DHT7100 is to select one of the three basic functions: DVD, Tuner or Aux.

1 DVD Function

Press the DVD button to watch movies on DVD or VCD or listen to music on CD or MP3-CD.

2 Tuner Function

Press the TUNER/BAND button repeatedly to switch between the AM and FM receiver.

3 Aux Function

Press the AUX button to listen to an external audio source (such as the audio from your VCR) connected to the rear AUX IN jacks.

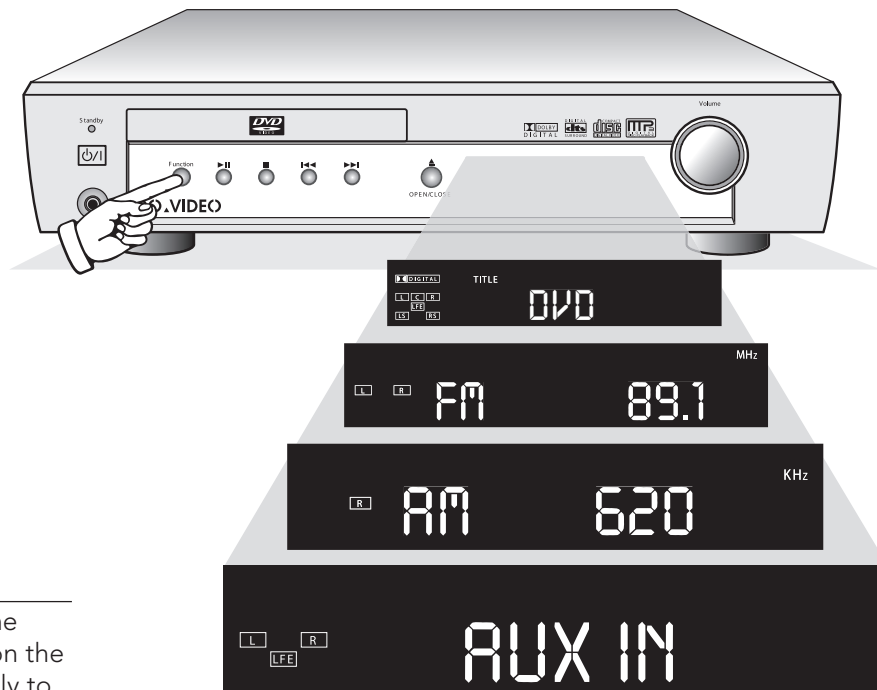

NOTE

- You can also press the FUNCTION button on the front panel repeatedly to select DVD, AM, FM or AUX.

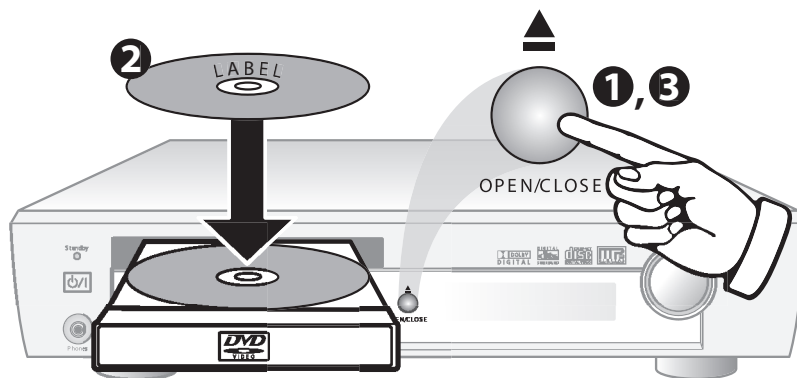

BASIC DISC PLAYBACK

Follow these steps to playback a DVD, CD, VCD or MP3-CD:

1. Press the OPEN/CLOSE button on the front panel to open the disc tray.
2. Insert the disc with the label side up.
 - If your DVD is double-sided, orient the disc with the desired label facing up.
3. Press the OPEN/CLOSE button again to close the disc tray.
4. Press the PLAY/PAUSE ►|| button to begin playback.
 - Many discs will begin playback automatically when they are inserted.
 - If the DVD has a disc menu, or more than one title, the disc menu may appear (see Disc Menu Navigation below).

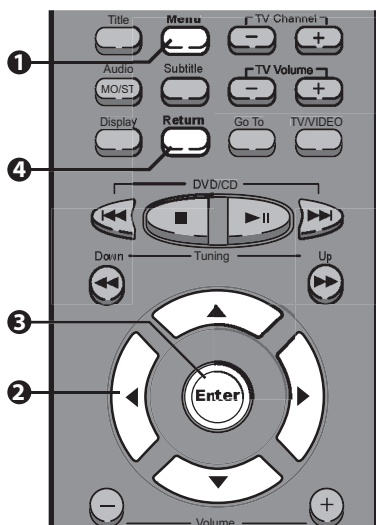

Use these keys to navigate DVD disc menus.

DISC MENU NAVIGATION

Use the following keys to navigate DVD disc menus, which allow you to select titles, chapters and special features on the disk.

1 Menu

Press the MENU button to display the disc menu for the currently loaded DVD.

2 Arrow Keys ▲▼, ◀▶

Press the ARROW keys to move the cursor up, down, left and right in the disc menu.

3 Enter

Press the ENTER button to confirm settings in the disc menu.

4 Return

Press the RETURN button to display the previous menu or to exit the disc menu.

NOTE

- A *Title* is a movie on a DVD disc.
- Each Title on a DVD disc is divided into several smaller sections called *Chapters*.

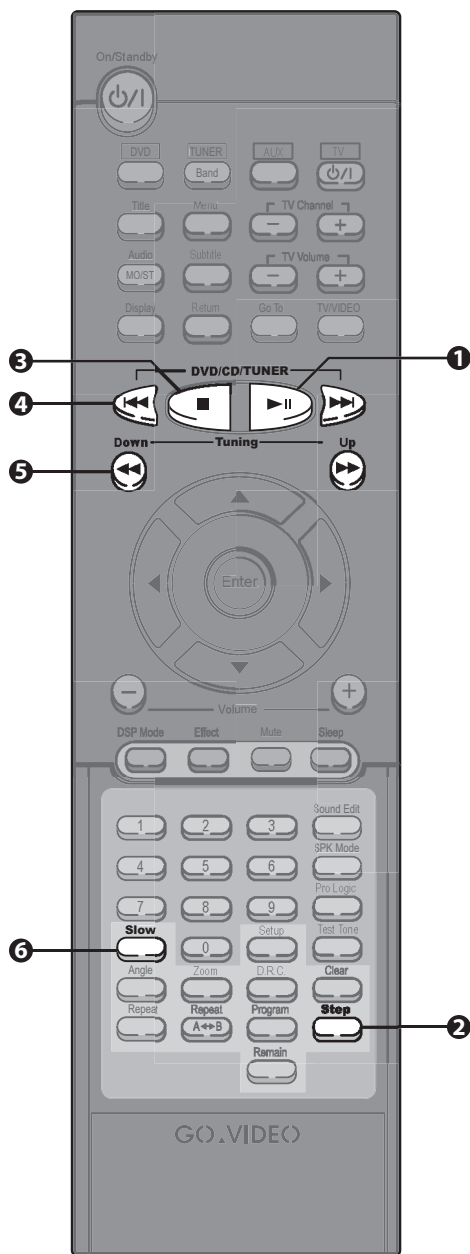

Use these keys for enhanced control during playback.

OPTIONS DURING PLAYBACK

While a disc is playing, you can choose from a variety of playback options:

1 Freeze

While a disc is playing, press PLAY/PAUSE ►|| to freeze playback. Press PLAY/PAUSE ►|| again to resume playback.

2 Frame Advance

Press the STEP button to step forward one frame at a time. Press PLAY/PAUSE ►|| to resume normal playback.

3 Stop/Resume

Press the STOP ■ button to stop and hold DVD or CD playback at the current playback point ("Pre-Stop"). If you press PLAY/PAUSE ►|| the movie will resume at this point. Press STOP ■ twice to stop fully and reset the disc at the beginning.

4 Skip Forward/Skip Back

While a DVD or CD is playing, press the SKIP FORWARD ►► or SKIP BACK ◄◄ buttons to skip to the next or previous chapter or track.



5 Scan Forward/Scan Back

While a DVD or CD is playing, press SCAN FORWARD ►► or SCAN BACK ◄◄ to scan forward or backward at variable speeds.

6 Slow Motion

While a DVD is playing, press the SLOW button for slow motion playback at 1/2 and 1/4 speeds.

NOTE

- If the player is left in pause for more than 5 minutes, it will stop automatically.

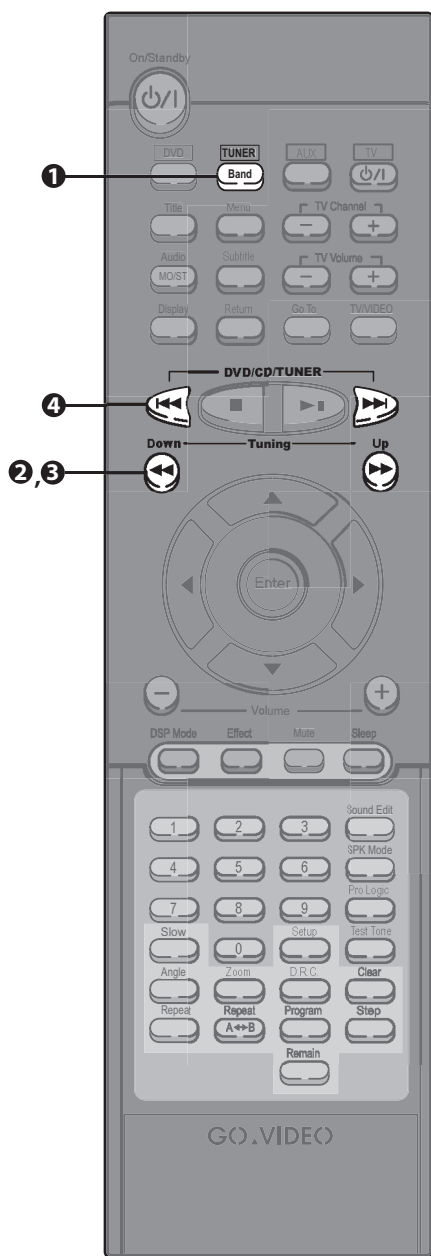

Use these keys to listen to AM or FM radio.

LISTENING TO THE RADIO

1 Selecting the AM/FM Tuner

- *Remote Control* - Press the TUNER/BAND button until the desired tuner band (AM or FM) appears on the front panel display.
- *Front Panel* - Press the FUNCTION button until the desired tuner band (AM or FM) appears on the front panel display.

2 Manually Selecting Stations

- *Remote Control* - Press the TUNING UP/DOWN ◀◀/▶▶ buttons to manually tune the desired station.
- *Front Panel* - Press the STOP ■ button to select MANUAL mode, then press the ◀◀/▶▶ buttons to manually tune the desired station.

3 Auto Searching for Stations

- *Remote Control* - Press and hold the TUNING UP/DOWN ◀◀/▶▶ buttons to automatically search for the next available station.
- *Front Panel* - Press the STOP button to select MANUAL mode, then press and hold the ◀◀/▶▶ buttons to automatically search for the next available station.

4 Browsing Preset Stations

- *Remote Control* - Press the SKIP BACK ◀◀ and SKIP FORWARD ▶▶ buttons to select the next Preset Station.
- *Front Panel* - Press the STOP button to select PRESET mode, then press the ◀◀ ▶▶ buttons to select the next Preset Station.

See page 11 to program Presets!

VOLUME SETTINGS

- 1 Adjust the volume by turning the **VOLUME** control on the front panel or the **VOLUME -/+** buttons on the remote control. Volume can be set from 0 (MIN) to 70 (MAX).
- 2 Press the **MUTE** button to mute the audio.
- 3 For more private listening, you can plug **headphones** into the 1/4" stereo headphone jack located on the front panel. No sound will come from the speakers.
- 4 Press the **Audio/MO/ST** button repeatedly to choose between Mono or Stereo sound. In poor reception areas, select Mono for a clear, interference-free broadcast.

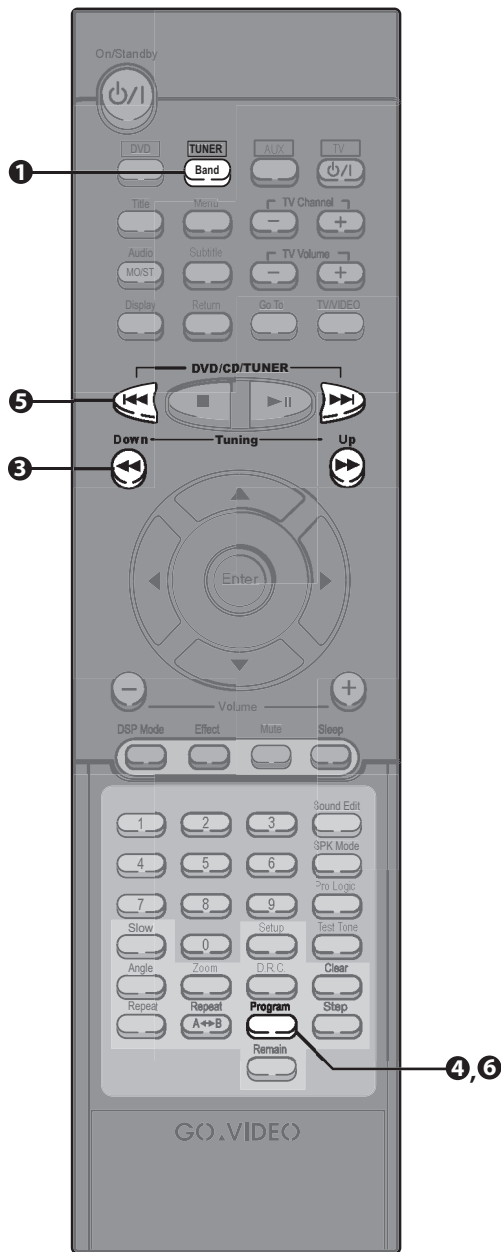

Use these keys to program up to 30 Preset radio stations.

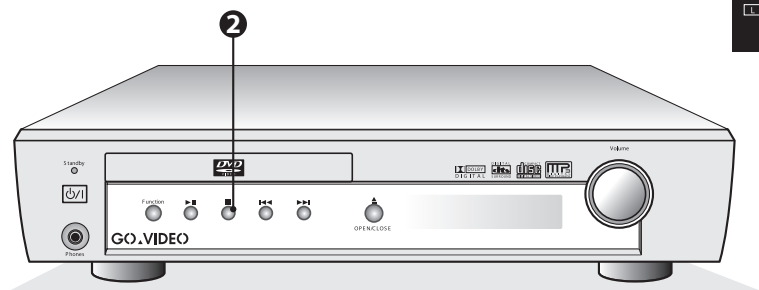

PROGRAMMING STATION PRESETS

You can save up to 30 station Presets, 15 each for AM and FM:

1 Select the Tuner

Press the TUNER/BAND button on the remote control or the FUNCTION button on the front panel until the desired tuner band (AM or FM) appears on the front panel display.

2 Select Manual

Press the STOP ■ button on the front panel until MANUAL appears on the front panel display.



3 Tune the Desired Station

Press the TUNING UP/DOWN ◀◀/▶▶ buttons to tune in the desired station.

4 Program the Station

Press the PROGRAM button on the remote control to program the station. PROGRAM will appear on the front panel display above the station number.



5 Choose a Preset Number

Press the SKIP BACK ◀◀ and SKIP FORWARD ▶▶ buttons to select one of the 15 Preset position numbers (FM1~FM15, or AM1~AM15).

6 Program the Preset

Press PROGRAM again to save the Preset. PROGRAM will disappear from the display.



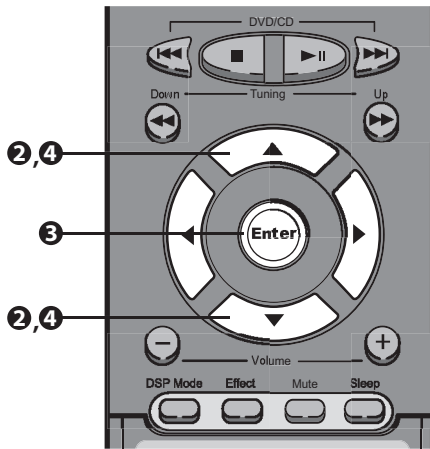

Use these keys to playback MP3 files.

WHAT IS MP3?

MP3 stands for MPEG1 Layer 3, the global standard for audio compression, which can reduce file sizes up to 12 times without degrading sound quality.

MP3 PLAYBACK

Follow these steps to playback an MP3-CD:

1 Insert MP3-CD

Press the OPEN/CLOSE button on the front panel to open the disc tray and insert your MP3-CD. Press the OPEN/CLOSE button again to close the disc tray.

- The first song in the first folder will begin playing automatically and the MP3 playback menu will appear.
- MP3 file names are shortened to 8 characters.
- The total track time and time remaining appear in the upper right corner of the screen.

2 Browse MP3 Files

Use the UP/DOWN ARROW keys to browse up and down the list of MP3 files.

- While browsing, you can quickly jump to the currently playing selection by pressing the LEFT ARROW key.

3 Play an MP3 File

Press the ENTER key to begin playback of any highlighted file.

4 Change Folders

Use the UP/DOWN arrow keys to highlight the folder at the top of the current song list, then press ENTER. Pick a new folder, and then press ENTER to open it.

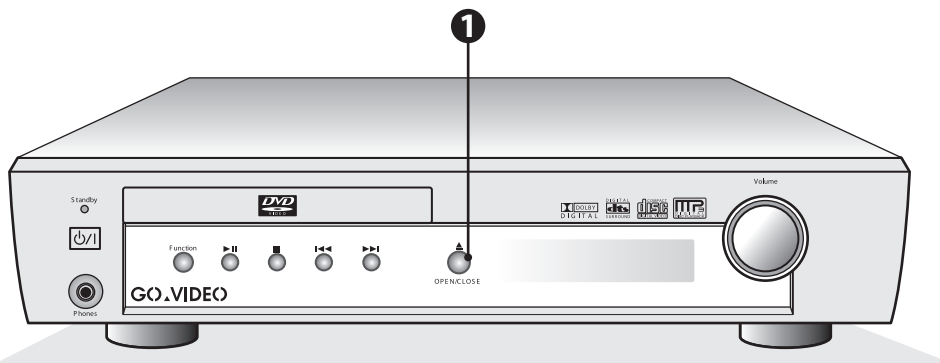

3

SPECIAL FEATURES

This chapter shows you how to use special playback and operations features of your DHT7100. Each feature is named for the remote control button that activates it.

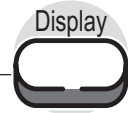

DISPLAY

Press the DISPLAY button to view the on-screen display, which provides a snapshot of the currently loaded disc. The first press brings up the first display. The second press brings up the second display, and the third press turns off the on-screen display.

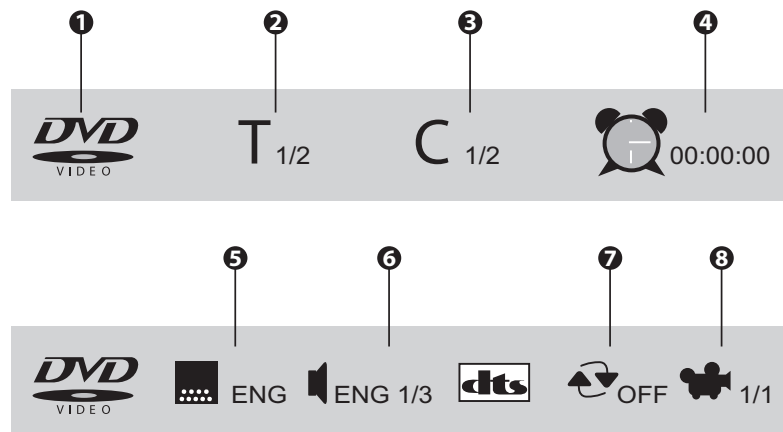

1 Disc Type

Indicates the type of the currently loaded disc: DVD, CD, VCD, or MP3-CD.

2 Title

Indicates the current Title number and the total number of Titles.

3 Chapter/Track

Indicates the current Chapter/Track number and the total number of Chapters/Tracks.

4 Time Remaining

Indicates the current counter position in hours, minutes, and seconds.

5 Subtitle Language

Indicates the current Subtitle language and the total number of Subtitle languages available on the disk.

6 Audio Language

Indicates the current Audio language/format and the total number of Audio languages/formats available on the disk.

7 Repeat Mode

Indicates the current Repeat Mode.

8 Angle

Indicates the current Angle and the total number of Angles available on the disk.

NOTE

- If the INVALID symbol appears on the screen when you press a button, that feature is not available on the loaded disc.





Go To

GO TO

1. Press the GO TO button repeatedly to jump to one of the following:
 - Title
 - Chapter/Track
 - Time
2. Use the 0-9 keys or the LEFT/RIGHT ARROW keys to enter the desired title, chapter/track or counter position (in hours, minutes and seconds).
3. Press ENTER to start playback.

Title

TITLE

With DVD loaded

1. Press the TITLE button to display the Title menu of the currently loaded DVD (not all DVDs have a multiple Titles and/or Title menus).
2. Use the 0-9 keys or ARROW keys to select the desired title.
3. Press ENTER to start playback.

With VCD loaded

1. Press the TITLE button to display the Disc View menu of the currently loaded VCD.

2. Press 1 for Track View or 2 for Index View:

Track View

Shows you nine thumbnail views, representing the first 9 tracks on the disk.

Index View

Shows you nine thumbnail views, representing the complete disc divided into nine scenes of equal length. This feature is useful if the VCD is not divided into tracks.

3. Use the 1-9 keys or ARROW keys to select the desired scene.
4. Press ENTER to start playback.

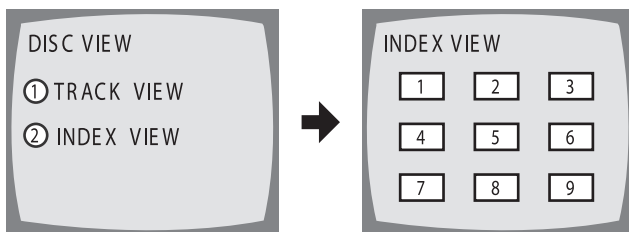



Angle



ANGLE

While a DVD is playing, press the ANGLE button to select among all available angles on the disc (not all DVDs contain multiple angles).

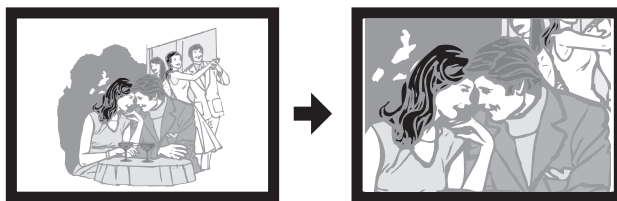

Zoom



ZOOM

While a DVD is playing, press the ZOOM button repeatedly to magnify the image at two or four times normal size.

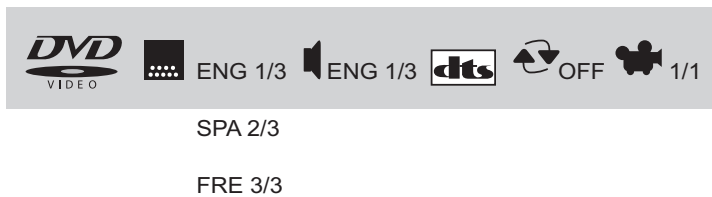

Subtitle



SUBTITLE

While a DVD is playing, press the SUBTITLE button repeatedly to select among all available subtitle languages on the disc.

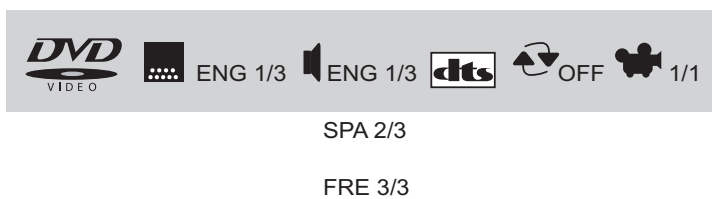

Audio

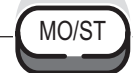

AUDIO

While a DVD is playing, press the AUDIO button repeatedly to select among all available audio tracks/formats on the disc.



Repeat



REPEAT

Press the REPEAT button to repeat playback of the current title, chapter or track.

Repeat



AB REPEAT

Press the REPEAT A↔B button to playback a segment of a movie or song in a continuous loop.

1. Press once to mark point A (the start of the looping segment).
2. Press again to mark point B (the end of the looping segment).
 - The segment will play from A to B in a continuous loop.
3. Press a third time to cancel AB Repeat.

Program



PROGRAM

You can program a custom order for playback of a DVD or CD.

1. Insert a DVD or CD and press the PROGRAM button.
2. Press the ENTER button to select the first Title placeholder.
3. Use the 0-9 keys to enter the desired Title number, and then press ENTER.
4. Use the 0-9 keys to enter the desired chapter/track number, and then press Enter.
 - To select ALL, press Enter when the space is blank (→).
5. Repeat steps 3 and 4 to program each title/chapter/track number in your custom playback list.
 - To erase a setting, use the UP/DOWN arrow keys to highlight it, and then press the CLEAR button.
6. Press PLAY/PAUSE to begin playback.
 - The chapters/tracks will playback in the order you specified.

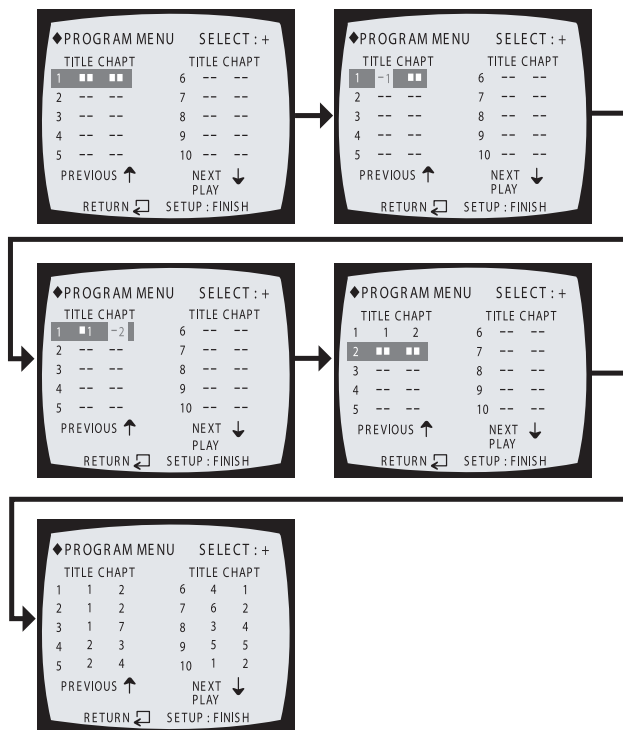

NOTE

- To cancel Program play, press the STOP button twice.
- You can also cancel Program Play by pressing the OPEN/CLOSE button on the front panel to eject the disk.



TITLE REM. TIME

CHAPTER TIME

CHAPTER REM. TIME

TITLE TIME

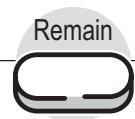

REMAIN

Press the REMAIN button to see how much time remains on the current Title, Chapter or Track. Each press will change the display to one of the following:

- Total length of the current Title.
- Time remaining in the current Title.
- Total length of the current Chapter.
- Time remaining in the current Chapter.



DRC (DYNAMIC RANGE COMPRESSION)

With DVD in Stop

While a DVD is loaded, press DRC to set Dynamic Range Compression to:

- DRC ON - Compresses the dynamic audio range of the DVD soundtrack for watching movies late at night or when you don't want to disturb others. Loud passages will be quieter, and soft passages will be louder.
- DRC OFF - Cancels Dynamic Range Compression.



Sleep



SLEEP

You can set the DHT7100 to sleep (power off and go into Standby mode) after a predetermined time from 10-150 minutes.

1. Press the SLEEP button on the remote control repeatedly until the desired sleep countdown appears on the front panel display:
 - SLEEP 10
 - SLEEP 20
 - SLEEP 30
 - SLEEP 60
 - SLEEP 90
 - SLEEP 120
 - SLEEP 150
 - OFF
2. The system will power off after the time has elapsed.

Note: To cancel the sleep timer, press the SLEEP button until OFF appears on the front panel display.

Pro Logic



PRO LOGIC

You can enjoy Dolby Pro Logic surround sound while listening to any stereo audio source, including the FM tuner, CD playback, MP3 playback, or a stereo source connected to the Aux Input, such as a VCR.

1. While a stereo source is playing, press the PRO LOGIC button on the remote control repeatedly until the desired surround format appears on the front panel display:
 - PRO LOGIC - Left, Center, Right, Subwoofer and Surround Channels
 - 3-STEREO - Left, Center, Right and Subwoofer Channels
 - STEREO - Left, Right and Subwoofer Channels

Note: The Pro Logic feature is not applicable with DVDs encoded with Dolby Digital 5.1 soundtracks.



DSP MODE

While listening to stereo soundtracks, you can customize the sound to approximate the sound inside a hall, theater, pavilion, etc.

1. While in one of the 3 Pro Logic modes, press the DSP MODE button to select from the following:
 - HALL
 - THEATER
 - PAVILION
 - DANCE CLUB
 - LIVE CLUB



EFFECT

Finally, while listening to a stereo DSP mode (see above), you can try four different effects, or “degrees” of each mode. Each one gradually intensifies the given DSP effect.

1. While in one of the 5 DSP Modes, press EFFECT to select from the following:
 - EFFECT 1
 - EFFECT 2
 - EFFECT 3
 - DEFAULT

4

ADVANCED SETUP

This chapter shows how to fine tune your speaker settings, including size, delay, balance and levels. You can also set language preferences, screen size, and digital output.

SPK Mode



SETTING SPEAKER SIZES

Press the SPK MODE button repeatedly to set the relative size of each speaker:

Front Speaker Size

Press the LEFT/RIGHT ARROW keys to select SMALL (default) or LARGE.

Center Speaker Size

Press the LEFT/RIGHT ARROW keys to select SMALL (default), LARGE or NONE.

Rear Speaker Size

Press the LEFT/RIGHT ARROW keys to select SMALL (default), LARGE or NONE.

Subwoofer Size

Press the LEFT/RIGHT ARROW keys to select USE (default) or NONE.



ADDING CENTER & REAR DELAYS

If your center and/or rear speakers are closer to your primary listening area than your front speakers, you can add a delay so that the sound from all five speakers arrives at approximately the same time. Assume 1 MS (millisecond) of delay for every one foot of distance; see "Calculating Delays" on page 21.

Press the SPK MODE button repeatedly to adjust each of the following:

Center Delay

Press the LEFT/RIGHT ARROW keys to set the center speaker delay from 0-5MS.

Rear Delay

Press the LEFT/RIGHT ARROW keys to set the rear speaker level from 0-10MS.

NOTE

- It is not necessary to change speaker size settings unless you are connecting different speakers to the unit.
- Be sure to use speakers with the same specifications (see p. 28)

CALCULATING DELAYS

1. Measure the distance from your front speakers to your primary listening area (e.g., 10 feet)
2. Measure the distance from your center speaker to your primary listening area (e.g., 7 feet) and your rear speakers to your primary listening area (e.g., 4 feet).
3. Calculate the difference between these two distances (10-7=3 feet, and 10-4= 6 feet).
4. Assuming 1 MS (millisecond) delay for every foot of distance, calculate the proper delay, e.g. 3 MS for the center delay and 6 MS for the rear delay.

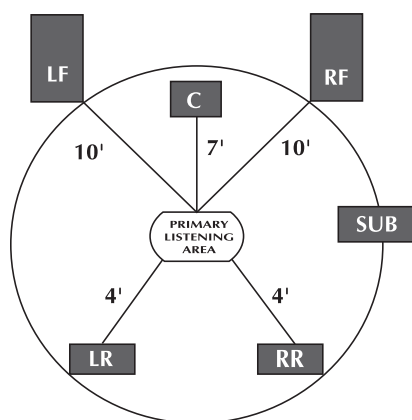

SETTING SPEAKER BALANCE AND LEVELS

You can adjust the balance and relative volume levels for each of the six speakers. To test your sound levels with a neutral "white noise" signal, press the Test Tone button (see "Using the Test Tone Generator" below).

Press the SOUND EDIT button repeatedly to adjust each of the following:

Front Speaker Balance

Use the LEFT/RIGHT ARROW keys to set the balance between the left and right front speakers (from -6dB ~ 0 for each speaker)



Rear Speaker Balance

Use the LEFT/RIGHT ARROW keys to set the balance between the left and right rear speakers (from -6dB ~ 0 for each speaker)



Center Speaker Level

Use the LEFT/RIGHT ARROW keys to set the center speaker level relative to the front speakers (from -6dB ~ +6dB, or OFF)



Rear Speaker Levels

Use the LEFT/RIGHT ARROW keys to set the rear speaker levels relative to the front speakers (from -6dB ~ +6dB, or OFF)



Subwoofer Level

Use the LEFT/RIGHT ARROW keys to set the subwoofer level relative to the front speakers (from -2dB ~ +10dB, or OFF)



Test Tone

USING THE TEST TONE GENERATOR

To help you fine tune your speakers levels, a Test Tone generator is provided which sends a neutral "white noise" for ~5 seconds to each speaker.

1. Press the TEST TONE button.
2. The Test signal will be sent to the Left Front, Center, Right Front, Right Rear, Left Rear and Subwoofer, in that order.
3. While the Test signal is playing, use the VOLUME +/- keys or VOLUME knob to fine-tune your levels.
4. Press the TEST TONE button again to cancel.

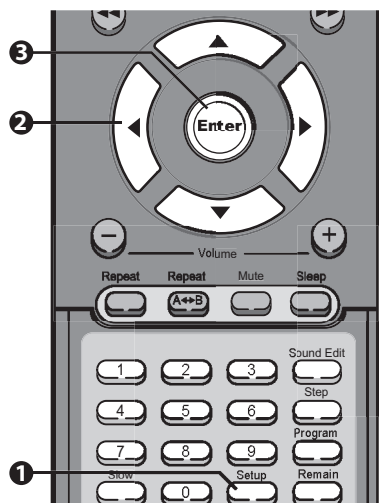

SETUP MENU NAVIGATION

The DHT7100 Setup menu allows you to choose language, screen size, rating level and digital audio output preferences. Use the following keys to navigate the Setup menu:

1 Setup Button

While playback is stopped, press the SETUP button to display the DHT7100 Setup menu. Also press the SETUP button to exit the Setup menu.

2 Arrow Keys ▲▼, ◀▶

Press to move the cursor up, down, left and right in the Setup menu.

3 Enter Button

Press to confirm selections in the Setup menu.

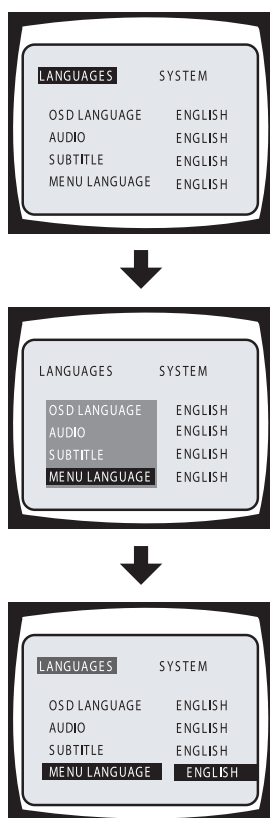

LANGUAGE PREFERENCES

1. While the player is in Stop mode, press the SETUP button.
2. Use the LEFT/RIGHT ARROW keys to select "Language."
3. Use the UP/DOWN ARROW keys to highlight one of the following, then press the ENTER button to select:

OSD Language

The language you select will be used in the Setup Menu and all On-Screen Displays. Use the UP/DOWN ARROW keys to select English, French or Spanish, then press ENTER.

Audio

The language you select will be the default Audio language for DVD playback (if it is available on the loaded disc); otherwise, the disc's default Audio language will be used. Use the UP/DOWN ARROW keys to select one of the languages listed, then press ENTER.

Subtitle

The language you select will be the default Subtitle language for DVD playback (if it is available on the disc); otherwise, the disc's default subtitle language will be used. Use the UP/DOWN ARROW keys to select one of the languages listed, then press ENTER.

NOTE

- Choose "Original" for Audio, Subtitle and/or Menu Language if you want the system to select the disc's default language.

Menu Language

The language you select will be the default language for DVD disc menus (if it is available on the disc); otherwise, the disc's default menu language will be used. Use the UP/DOWN ARROW keys to select one of the languages listed, then press ENTER.

4. Press the SETUP button to exit the menu system.

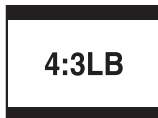
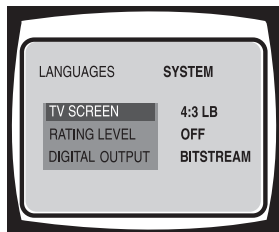

TV SCREEN SIZE

The TV Screen setting will ensure that the DHT7100 displays movies appropriately for the shape of your television screen.

1. While the player is in Stop mode, press the SETUP button.
2. Use the LEFT/RIGHT ARROW keys to select "System."
3. Use the UP/DOWN ARROW keys to select "TV Screen," then press the ENTER button.
4. Use the UP/DOWN ARROW keys to set the screen size to:

4:3 LB (Letterbox)

Select if you want DVD movies to display at their full widescreen width on a standard 4:3 television screen (4:3 refers to the ratio of the width of the screen to its height). This will cause black bars to appear above and below the picture.

4:3 PS (Pan & Scan)

Select if you want DVD movies to fill the screen on a standard 4:3 television screen.

16:9

Select if you have a widescreen television with a 16:9 aspect ratio.

5. Press ENTER to confirm your selection.
6. Press the SETUP button to exit the menu system.

NOTE

- If the DVD movie is recorded in a 4:3 aspect ratio, you will not be able to view the full 16:9 picture even in 4:3 LB or 16:9 mode.

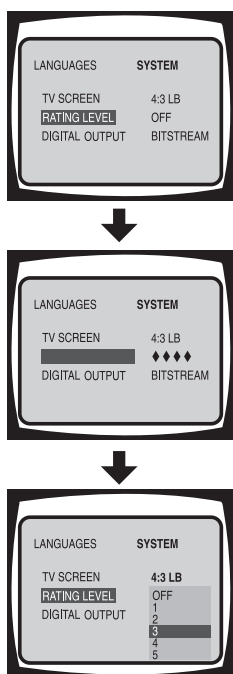

IF YOU FORGET YOUR PASSWORD:

While the player is in Stop mode, hold the STOP button down on the front panel for at least 5 seconds. "INITIAL" will appear on the front panel display and all default settings will return to their factory presets.

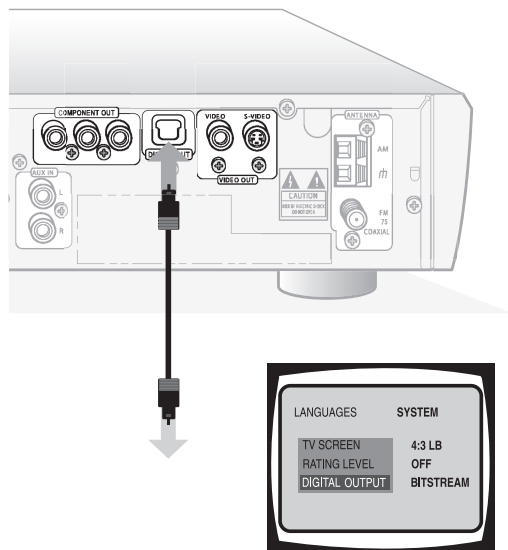

Set the Digital Out to Bitstream or LPCM

RATING LEVELS

The DHT7100 features a password-protected rating system to prevent playback of DVDs with objectionable material.

1. While the player is in Stop mode, press the SETUP button.
2. Use the LEFT/RIGHT ARROW keys to select "System."
3. Use the UP/DOWN ARROW keys to select "Rating Level," then press ENTER.
4. Use the 0-9 keys to enter a 4-digit password, then press ENTER.
 - The player's password is set to "7890" by default.
5. Use the UP/DOWN ARROW keys to select either RATING LEVEL or NEW PASSWORD, then press ENTER.
 - 1 is most restrictive, and 8 is least restrictive. If 6 is selected, a disc rated 7 or above cannot be played.
 - If you select NEW PASSWORD, the screen changes and enables you to enter the new password.
6. Press the SETUP button to exit the menu system.

DIGITAL OUTPUT FORMAT

If you have connected the DHT7100 to an A/V receiver with a Dolby Digital and/or DTS decoder, you can specify the format of the outgoing digital audio signal.

1. While the player is in Stop mode, press the SETUP button.
2. Use the LEFT/RIGHT ARROW keys to select "System."
3. Use the UP/DOWN ARROW keys to select "Digital Output," then press ENTER.
4. Use the UP/DOWN ARROW keys to set the Digital Output to:

Bitstream

Sends a digital signal that carries the Dolby Digital 5.1 and/or DTS multichannel information to your external decoder.

LPCM

Sends a linear PCM (Pulse Code Modulation), or 2-channel stereo signal, to your A/V receiver.

5. Press ENTER to confirm your selection.
6. Press the SETUP button to exit the menu system.

5

HELP

This Chapter provides customer support information, as well as a list of frequently asked questions, technical specifications and the product warranty.

The table below will help you solve common challenges with your DVD system. If you don't find the answers you need here, you can contact our Customer Service Department as follows:

Phone: (480) 922-0896
Office hours: Monday-Friday, 6:00 a.m. to 9:00 p.m. MST
Saturday-Sunday, 8:00 a.m. to 4:00 p.m. MST
E-Mail: "customerservice@sensoryscience.com"
Web: "www.govideo.com" or
"www.sensoryscience.com"

SYMPTOMS

SOLUTIONS

Disc tray does not open.

- Is power cord plugged securely into power outlet?
- Turn off power to unit by pressing Power button and then turn the player back on.

Disc does not play.

- Check region number of DVD. DVD discs purchased abroad may not be playable.
- This player cannot play CD-ROMs, DVD-ROMs, etc.
- Check rating level of DVD.

Playback does not start immediately.

- Check whether disc has any scratch marks or is deformed.

No sound.

- Is power cord plugged securely into power outlet?
- It is normal not to have sound during high-speed, slow or step playback.
- Are speakers properly connected?
- Is speaker Setup correctly customized?
- Is disc installed with label side facing up?
- Is disc severely damaged?
- Disc may be dirty. Wipe off fingerprints or dirt.
- Press the TEST TONE button to verify that the Test Tone is working.

No picture and disc tray opens.

- Was player moved suddenly from cold to warm environment? When condensation forms inside player, remove disc and let player stand for 1 or 2 hours with power on.

SYMPTOMS	SOLUTIONS
Poor sound quality.	<ul style="list-style-type: none"> • Are speaker cables loose? • Is there any dirt or debris at the end of the speaker connectors?
Dolby Digital 5.1 not working.	<ul style="list-style-type: none"> • Is disc labeled "Dolby Digital"? • Are speakers properly connected?
No picture or poor picture quality.	<ul style="list-style-type: none"> • Is TV power turned on? • Are video cables properly connected? • Is player in Pause? • Is there any dirt on disc, or is disc damaged? • Some DVD discs are not playable due to poor quality manufacturing. • When a dark scene changes to a bright scene during playback, screen may flicker vertically. Some disturbance is normal.
Remote control does not work.	<ul style="list-style-type: none"> • Is the remote control within 23' of the remote sensor and within a 30 degree angle? • Are there any obstacles between the remote control and the remote control sensor? • Are batteries drained or dead?
No audio or subtitle language.	<ul style="list-style-type: none"> • Some DVDs do not include multiple audio or subtitle languages.
Menu screen does not appear.	<ul style="list-style-type: none"> • Is the remote control within 23' of the remote sensor and within a 30 degree angle? • Are the batteries dead? • Does disc have a Menu?
Lost password or malfunctioning unit.	<ul style="list-style-type: none"> • While player is in Stop mode, press and hold the STOP ■ button on the front panel for at least 5 seconds. "INITIAL" will appear on the front panel display and all settings will return to factory presets. Do not use this function unless necessary because it will erase all settings.
Desired radio station cannot be tuned in.	<ul style="list-style-type: none"> • Is antenna installed properly? • When antenna's input signal is weak, install external FM antenna in area with good reception quality.
Cannot view widescreen movie.	<ul style="list-style-type: none"> • Some DVDs only include standard 4:3 formatting. Refer to DVD disc jacket.
CD-R/CD-RW discs do not play.	<ul style="list-style-type: none"> • Make sure the CD-R/CD-RW recording session is properly terminated or discs will not be playable. • CD-RW has a lower reflection rate than CD-R media and will take longer to read than CD-R discs. For best results, set your CD burner to write discs at low speed. • If there are multiple sessions on the disc, only the first session will be recognized.

DISC HANDLING PRECAUTIONS

- Hold the disc by the edges so the surface will not be soiled with fingerprints. Fingerprints, dirt and scratches can cause skipping and distortion.
- Do not write on the label side with a ball-point pen or other writing utensil.
- Do not use record cleaning sprays, benzene, thinner, static electricity prevention liquids or any other solvent.
- Be careful not to drop or bend the disc.
- Do not install more than one disc on the disc tray.
- Do not try to close the disc tray when the disc is not installed properly.
- Be sure to store the disc in its exclusive case when not in use.

If the surface is soiled

- Wipe gently with a soft, damp (water only) cloth.
- When wiping discs, always move the cloth from the center (if you wipe the discs using a circular motion, circular scratches are likely to occur, which will cause noise).
- If the disc is brought from a cold to a warm environment, moisture may form on the disc. Wipe this moisture off with a soft, dry, lint-free cloth before using the disc.

Improper disc storage

You can damage discs if you store them in the following places:

- Areas exposed to direct sunlight
- Humid or dusty areas
- Areas directly exposed to a heat outlet or heating appliance



Discs which can be played with this system:

- CD-DA
- Video-CD
- CD-R/CD-RW
- DVD
- MP3

SYSTEM MAINTENANCE

- Be sure to turn the unit off and disconnect the AC power cord before cleaning the system.
- Wipe the unit with a dry soft cloth. If the surfaces are extremely dirty, wipe clean with a cloth that has been dipped in a weak soap-and-water solution and wrung out thoroughly, and then wipe again with a dry cloth.
- Never use alcohol, benzene, thinner, cleaning fluid or other chemicals. And do not use compressed air to remove dust.

GENERAL	
Power Supply	120V, 60Hz
Power Consumption	120W
Weight	14.3 lbs (6.5Kg)
Dimensions (WxDxH)	14.6" x 3.1" x 11.8" (370mm x 300mm x 80mm)
Operating Temp Range	41-95° F (5-35° C)
Operating Humidity Range	10%~75%
FM TUNER	
Receiving Frequency	87.5~108MHz
Usable Sensitivity	10dB
S/N Ratio	60dB
Distortion	0.5%
Channel Separation	28dB
AM TUNER	
Receiving Frequency	522~1611MHz
Usable Sensitivity	54dB
S/N Ratio	40dB
Distortion	2%
VIDEO OUTPUT	
Video	1.0 Vp-p (75Ω load)
Component Video	Y: 1.0 Vp-p (75Ω load), Pr: 0.70 Vp-p (75Ω load), Pb: 0.70 Vp-p (75Ω load)
S-Video	Luminance: 1.0 Vp-p (75Ω load), Color: 0.286 Vp-p (75Ω load)
AMPLIFIER	
Front speaker Output	20W x 2 (6Ω)
Center speaker Output	20W (6Ω)
Rear speaker Output	20W x 2 (6Ω)
Subwoofer speaker Output	40W (3Ω)
Frequency range	20Hz~25KHz
S/N Ratio	75dB
Channel separation	50dB
Input sensitivity	(AUX) 500mV
SPEAKERS	
SPEAKER SYSTEM	5.1ch speaker system
Impedance	6Ω x 5 (Sub: 3Ω)
Frequency range	150Hz~18KHz (Sub: 45Hz~250Hz)
Output sound pressure level	87dB/W/M (Sub: 86dB/W/M)
Rated input	40W (Sub: 70W)
Maximum input	80W (Sub: 140W)
Dimensions	Front/Rear: 4.1" x 5.9" x 4.7" (103mm x 150mm x 120mm) Center 7.8" x 4.1" x 4.7" (197mm x 103mm x 120mm) Sub 9.8" x 15.9" x 13.2" (250mm x 403mm x 335mm)
Weights	Front/Rear 1.6 lbs (0.73Kg) Center 1.8 lbs (0.80Kg) Sub 15 lbs (6.8Kg)
ANALOG OUTPUT	
2 Channel	48KHz/96KHz Sampling; 44.1KHz Sampling;
5.1 Channel	44.1KHz Sampling 48KHz/96KHz Sampling

90 days labor
1 year parts

Who Provides the Limited Warranty

During the warranty period, the Go-Video Warranty Administrator will honor DVD system service for 90 days labor, 1 year parts from the original date of consumer purchase. See below for Commercial, Industrial or Educational use coverage. The DVD system remote control is warranted for 90 days from the date of purchase.

Who is Protected

This warranty protects the original consumer owner of this Go-Video product.

What is Covered and How Long

This warranty covers internal operating parts and service/labor to repair or replace covered parts in this Go-Video product for 90 days labor, 1 year parts, from the date of purchase, defined as follows: (1) Original Consumer Retail Purchase; (2) First Rental Purchase Agreement; or (3) First Lease Purchase Agreement (the "Warranty Period"). Labor and replacement parts supplied during the Warranty Period are covered only for the remaining portion of the original Warranty Period. The Go-Video Warranty Administrator shall have no liability for service under this warranty if non-OEM (Original Equipment Manufacturer) replacement parts are used in the repair of your Go-Video product.

What the Owner Must Do If Service is Required

If service under this warranty is required, contact the Go-Video Warranty Administrator at (480) 922-0896 to determine the nearest authorized Go-Video service center.

What are the Exceptions

This warranty does not cover: (1) Normal maintenance service, such as video head cleaning. (2) Damage from misuse, abuse neglect or accident, natural disasters or Acts of God. (3) Cabinetry, decorative parts, A/C adapters, knobs or buttons. (4) The foreign country use of this product. (5) Go-Video product which has been electronically or mechanically modified in any way or incorporated into other products. (6) Installation and setup service adjustments. (7) Owner instruction. Your Owner's Guide provides information regarding operating instructions and user controls. For additional information, contact your authorized Go-Video dealer.

- Go Video is not responsible for any shipping, handling or insurance charges.
- This Exclusive Limited Warranty excludes all incidental and consequential damages. Some states do not allow the exclusion of incidental and consequential damages, so the above exclusion may not apply to you.
- ALL IMPLIED WARRANTIES, INCLUDING IMPLIED WARRANTIES OF MERCHANTABILITY AND FITNESS FOR A PARTICULAR PURPOSE ARE LIMITED IN DURATION TO THE DURATION OF THIS WARRANTY PERIOD. Some states do not allow limitations on how long an implied warranty lasts, so the above limitation may not apply to you.
- This Exclusive Limited Warranty gives you specific legal rights and you may also have other rights which vary from state to state.

Go-Video Warranty Administrator

Sensory Science Corp.
 7835 East McClain Drive
 Scottsdale, Arizona 85260-1732
 (480) 922-0896
 customerservice@sensoryscience.com

INDEX

This Chapter provides a visual index of the front panel, front panel display, rear panel and remote control. This is followed by a topical index to the contents of this user's guide.

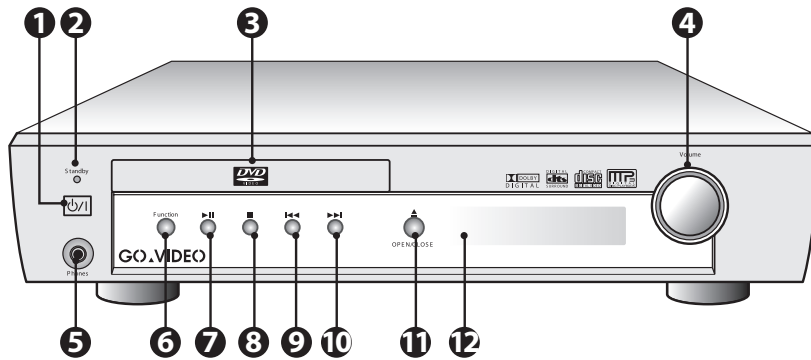

FRONT PANEL CONTROLS

- | | |
|---------------------------------|---|
| 1 Power \odot /I button, p. 4 | 7 Play/Pause \blacktriangleright button, p. 8 |
| 2 Standby indicator, p. 4 | 8 Stop \blacksquare button, p. 9 |
| 3 Disc tray, p. 8 | 9 Tuning Down/Skip Back $\blacktriangleleft\blacktriangleleft$ button, p. 9 |
| 4 Volume control, p. 10 | 10 Tuning Up/Skip Forward $\blacktriangleright\blacktriangleright$ button, p. 9 |
| 5 Headphone jack, p. 10 | 11 Open/Close button, p. 8 |
| 6 Function button, p. 7 | 12 Remote Sensor |

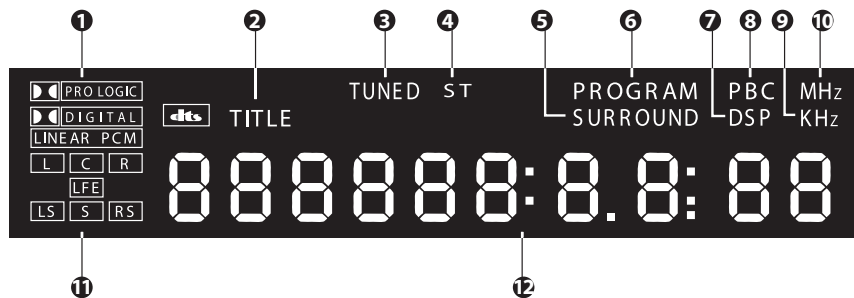

FRONT PANEL DISPLAY

- | | |
|--------------------------------------|---|
| 1 Playback Signal Indicators | 6 Program Indicator |
| • Dolby Pro Logic | 7 DSP (Digital Signal Processing) Indicator |
| • Dolby Digital | 8 PBC (Playback Control) Indicator - Lights if Video CD has a menu |
| • Linear PCM (Pulse Code Modulation) | 9 FM Station Indicator (MHz) |
| • DTS (Digital Theater Sound) | 10 AM Station Indicator (KHz) |
| 2 Title Indicator | 11 Speaker Status Indicators (Left, Center, Right, Low Frequency Effect (Subwoofer), Left Surround, Surround, Right Surround) |
| 3 Radio Station Tuned Indicator | 12 System Status Display |
| 4 Stereo Indicator | |
| 5 Surround Indicator | |

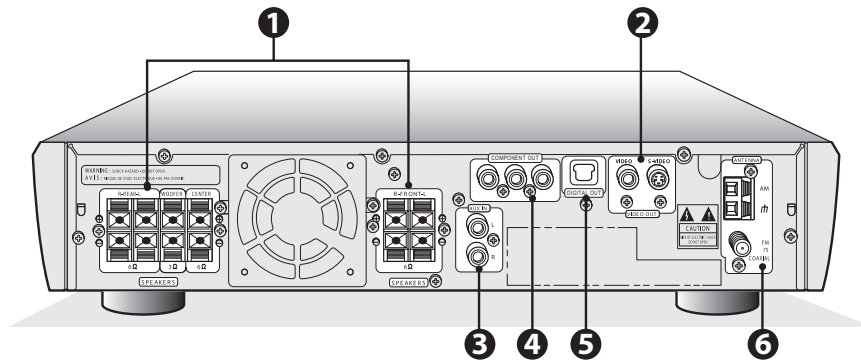

REAR PANEL

- | | |
|--|---|
| <p>1 5.1 Channel Speaker Outputs, p. 3</p> <ul style="list-style-type: none"> • Front (Right & Left) • Rear (Right & Left) • Center • Subwoofer <p>2 Composite and S-Video Outputs, p. 2</p> | <p>3 Auxiliary Audio Input (Right & Left), p. 6</p> <p>4 Component Video Output, p. 2</p> <p>5 Digital Audio Output (Optical), p. 6</p> <p>6 Antenna Connectors, p. 4</p> <ul style="list-style-type: none"> • AM Loop Antenna • FM 75Ω Coaxial |
|--|---|

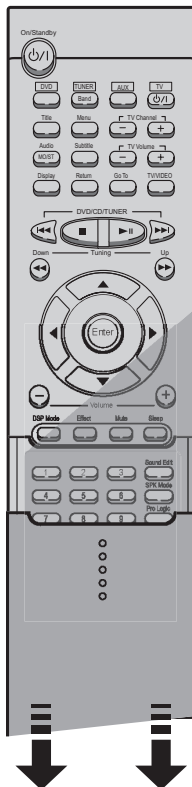

REMOTE CONTROL (UNDER SLIDING PANEL)

- | |
|---|
| <p>1 0-9 keys, p. 5</p> <p>2 Slow button, p. 9</p> <p>3 Angle button, p. 15</p> <p>4 Repeat, p. 16</p> <p>5 Zoom button, p. 15</p> <p>6 Repeat A↔B, p. 16</p> <p>7 Remain button, p. 17</p> <p>8 Program button, p. 16</p> <p>9 Step button, p. 9</p> <p>10 Clear button, p. 16</p> <p>11 Test Tone button, p. 21</p> <p>12 Pro Logic, p. 18</p> <p>13 SPK Mode button, p. 20</p> <p>14 Sound Edit button, p. 21</p> <p>15 D.R.C. button, p. 17</p> <p>16 Setup button, p. 22</p> |
|---|

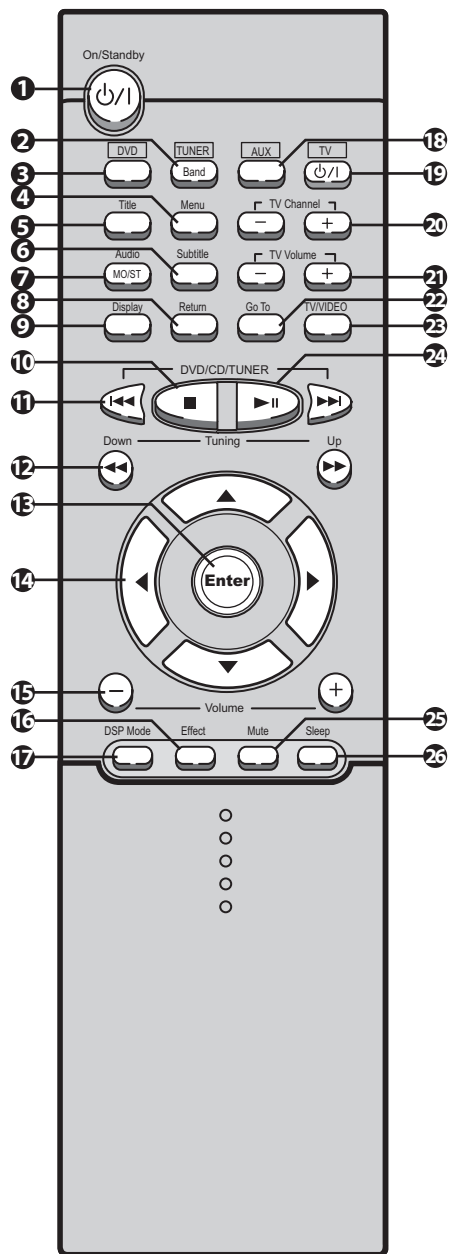

REMOTE CONTROL (TOP SECTION)

- 1 Power On/Standby ϕ /I button, p. 4
- 2 TUNER (Band) button, p. 7
- 3 DVD button, p. 7
- 4 Menu button, p. 8
- 5 Title button, p. 14
- 6 Subtitle button, p. 15
- 7 Audio (Mono/Stereo) button, p. 15
- 8 Return button, p. 8
- 9 Display button, p. 13
- 10 Stop \blacksquare button, p. 9
- 11 Skip Back \lll button, Skip Forward \ggg buttons, p. 9
- 12 Tuning Down (Scan Back) \lll button, Tuning Up (Scan Forward) \ggg buttons, p. 9, 10
- 13 Enter button, p. 8
- 14 Arrow \blacktriangle / \blacktriangledown / \blacktriangleleft / \blacktriangleright buttons, p. 8
- 15 Volume +/- buttons, p. 10
- 16 Effect button, p. 19
- 17 DSP button, p. 19
- 18 AUX button, p. 7
- 19 TV Power ϕ /I button, p. 5
- 20 TV Channel +/- buttons, p. 5
- 21 TV Volume +/- buttons, p. 5
- 22 Go To button, p. 14
- 23 TV/VIDEO button, p. 5
- 24 Play/Pause \blacktriangleright || button, p. 8
- 25 Mute button, p. 10
- 26 Sleep button, p. 18

SYMBOLS

16:9 23

3-Stereo Mode 18

4:3 LB (Letterbox) 23

4:3 PS (Pan & Scan) 23

A

AB Repeat 16

Accessories 2

AM Loop Antenna 2, 4

AM/FM Tuner 10

Angle button 15

Angle indicator 13

Arrow keys 8, 22

Audio Language 13, 22

Audio/MO/ST button 10, 15

AUX button 7

Aux In 6

B

Batteries 2

Bitstream 24

C

CD 1, 8

CD-R 1

CD-RW 1

Center Delay 20

Center Speaker Level 21

Center Speaker Placement 3

Center Speaker Size 20

Chapter 8, 13, 14

Clear button 16

Component Video 2

Composite Video 2

Customer Service 25

D

Dance Club mode 19

Delays, Calculating 21

Delays, Setting 20

Digital Out 6

Digital Output Format 6, 24

Disc Handling & Maintenance 27

Disc Menu Navigation 8

Disc Type 13

Display button 13

Dolby Digital 1, 6

Dolby Pro Logic 6, 18

DRC (Dynamic Range Compression) 17

DSP (Digital Signal Processing) 19

DSP MODE button 19

DTS 1, 6

DVD 1, 8

DVD button 7

E

Effects 19

ENTER button 8, 22

F

FM Antenna 2, 4

Frame Advance 9

Freeze 9

Front Speaker Balance 21

Front Speaker Placement 3

Front Speaker Size 20

Function button 7, 10, 11

G

Go To button 14

H

Hall mode 19

Headphones 10

Help 25

I

Index View 14

Invalid symbol 13

L

Language Preferences 22

Listening to the Radio 10

Live Club mode 19

LPCM 24

M

Manual mode 10, 11

Menu button 8

Menu Language 23

Mono 10

MP3 1

MP3, Defined 12

MP3 Playback 12

MP3-CD 8, 12

O

On-Screen Display 13

Open/Close button 8, 12

Original 22

OSD Language 22

P

Password 24
Pavilion mode 19
Play/Pause button 8, 9
Playback, Basic 8
Power button 4
Pre-Stop 9
Preset mode 10
Presets, Programming 11
Pro Logic button 18
Program button 11, 16
Program Playback 16

R

Rating Levels 24
Rear Delay 20
Rear Speaker Balance 21
Rear Speaker Levels 21
Rear Speaker Placement 3
Rear Speaker Size 20
Region 1
Remain button 17
Remote Control 2
 Programming 5
Repeat AB button 16
Repeat button 16
Repeat Mode 13
Return button 8

S

S-Video 2
Safety iii
Scan Back 9
Scan Forward 9
Setup button 22
Setup menu 22
Skip Back 9
Skip Forward 9
Sleep button 18
Sleep Timer 18
Slow button 9
Sound Edit button 21
Speaker Balance 21
Speaker Connections 3
Speaker Levels 21
Speaker Placement 3
Speaker Setup 20
Speaker Sizes, Setting 20

Spk Mode button 20
Standby mode 4
Step button 9
Stereo 10, 18
STOP button 10, 11
Stop button 9
Stop/Resume 9
Subtitle button 15
Subtitle Language 13, 22
Subwoofer Level 21
Subwoofer Placement 3
Subwoofer Size 20

T

Technical Specifications 28
Test Tone button 21
Test Tone Generator 21
Theater mode 19
Time Remaining 13
Title 8, 13, 14
Title button 14
Track 13, 14
Track View 14
Troubleshooting 25
Tuner/Band button 7, 10, 11
Tuning Up/Down buttons 10
TV Channel +/- buttons 5
TV Control keys 5
TV Power button 5
TV Screen Size 23
TV Volume +/- buttons 5
TV/Video button 5

V

VCD 8, 14
VCR Connections 6
Video cable 2
Video-CD 1
Volume +/- buttons 10
Volume control 10

W

Warranty 29

Z

Zoom button 15

ANY QUESTIONS?

Thank you for purchasing this Sensory Science DVD System!

Sensory Science specializes in developing and marketing innovative digital entertainment products, including digital televisions, Internet media players, DVD players, and high-end home theater components for the digital living room. We take pride in our ability to deliver unparalleled customer support, and are honored to have received the prestigious Inside Track award for Supplier Loyalty two years running. Should you have any questions, feel free to contact us using one of the methods listed below:

1-800-SENSORY • www.sensoryscience.com • dvdhelp@sensoryscience.com



S E N S O R Y
S C I E N C E

7835 East McClain Drive
Scottsdale, AZ 85260 USA
www.sensoryscience.com

Free Manuals Download Website

<http://myh66.com>

<http://usermanuals.us>

<http://www.somanuals.com>

<http://www.4manuals.cc>

<http://www.manual-lib.com>

<http://www.404manual.com>

<http://www.luxmanual.com>

<http://aubethermostatmanual.com>

Golf course search by state

<http://golfingnear.com>

Email search by domain

<http://emailbydomain.com>

Auto manuals search

<http://auto.somanuals.com>

TV manuals search

<http://tv.somanuals.com>