

---

# ***USE & CARE MANUAL***

---

THIS PORTABLE AIR CONDITIONER IS EQUIPPED WITH A NEW INDUSTRY  
STANDARD POWER SUPPLY CORD WITH A TEST-RESET FUNCTION

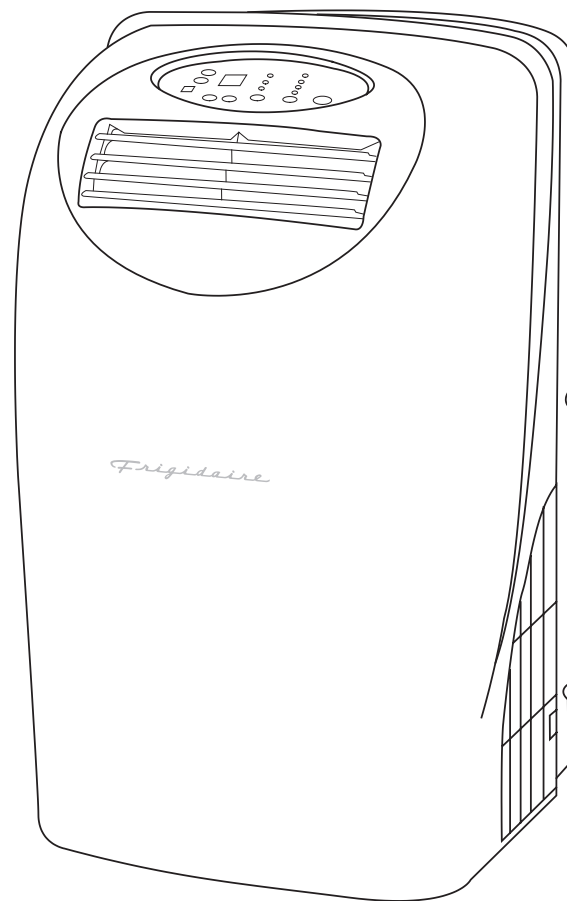

READ AND SAVE THESE INSTRUCTIONS

# **PORTABLE AIR CONDITIONER**

## **ELECTRONIC CONTROL**

---

P/N 220250d396

# ROOM AIR CONDITIONER WARRANTY

*Your product is protected by this warranty*

Your appliance is warranted by Electrolux. Electrolux has authorized Frigidaire Consumer Services and their authorized servicers to perform service under this warranty. Electrolux authorizes no one else to change or add to any of these obligations under this warranty. Any obligations for service and parts under this warranty must be performed by Frigidaire Consumer Services or an authorized Frigidaire servicer.

	WARRANTY PERIOD	FRIGIDAIRE, THROUGH ITS AUTHORIZED SERVICERS, WILL:	THE CONSUMER WILL BE RESPONSIBLE FOR:
<b>FULL ONE-YEAR WARRANTY</b>	One year from original purchase date.	Pay all costs for repairing or replacing parts of this appliance which prove to be defective in materials or workmanship.	Costs of service calls that are listed under <b>NORMAL RESPONSIBILITIES OF THE CONSUMER.*</b>
<b>LIMITED 2-5 YEAR WARRANTY (Sealed System)</b>	Second through fifth years from original purchase date.	Repair or replace any parts in the Sealed Refrigeration System (compressor, condenser, evaporator and tubing) proves to be defective in materials or workmanship.	Diagnostic costs and any removal, transportation and reinstallation costs which are required because of service. Costs for labor, parts and transportation other than with respect to the Sealed Refrigeration System.
<b>LIMITED WARRANTY (Applicable to the State of Alaska)</b>	Time periods listed above.	All of the provisions of the full and limited warranties above and the exclusions listed below apply.	Costs of the technician's travel to the home and any costs for pick up and delivery of the appliance required because of service.

## \* NORMAL RESPONSIBILITIES OF THE CONSUMER

**This warranty applies only to products in ordinary household use, and the consumer is responsible for the items listed below.**

1. Proper use of the appliance in accordance with instructions provided with the product.
2. Proper installation by an authorized servicer in accordance with instructions provided with the appliance and in accordance with all local plumbing, electrical and/or gas codes.
3. Proper connection to a grounded power supply of sufficient voltage, replacement of blown fuses, repair of loose connections or defects in house wiring.
4. Expenses for making the appliance accessible for servicing, such as removal of trim, cupboards, shelves, etc., which are not a part of the appliance when it was shipped from the factory.
5. Damages to finish after installation.
6. Replacement of light bulbs and/or fluorescent tubes (on models with these features).

## EXCLUSIONS

**This warranty does not cover the following:**

1. CONSEQUENTIAL OR INCIDENTAL DAMAGES SUCH AS PROPERTY DAMAGE AND INCIDENTAL EXPENSES RESULTING FROM ANY BREACH OF THIS WRITTEN OR ANY IMPLIED WARRANTY. Note: Some states do not allow the exclusion or limitation of incidental or consequential damages, so this limitation or exclusion may not apply to you.
2. Service calls which do not involve malfunction or defects in workmanship or material, or for appliances not in ordinary household use. The consumer shall pay for such service calls.
3. Damages caused by services performed by persons other than authorized Frigidaire servicers; use of parts other than Frigidaire Genuine Renewal Parts; obtained from persons other than such servicers; or external causes such as abuse, misuse, inadequate power supply or acts of God.
4. Products with original serial numbers that have been removed or altered and cannot be readily determined.

## IF YOU NEED SERVICE

Keep your bill of sale, delivery slip, or some other appropriate payment record. The date on the bill establishes the warranty period should service be required. If service is performed, it is in your best interest to obtain and keep all receipts. This written warranty gives you specific legal rights. You may also have other rights that vary from state to state. Service under this warranty must be obtained by following these steps, in order:

1. Contact Frigidaire Consumer Services or an authorized Frigidaire servicer.
2. If there is a question as to where to obtain service, contact our Consumer Relations Department at:

Frigidaire  
P.O. Box 212378  
Augusta, GA 30917  
**800-444-4944**

*Frigidaire*

Product features or specifications as described or illustrated are subject to change without notice. All warranties are made by Electrolux.

This warranty applies only in the 50 states of the U.S.A., Puerto Rico and Canada.



## Product Registration

### Record Your Model and Serial Numbers

Record in the space provided below the model and serial numbers. On all models, the serial plate is located on the outside of the cabinet.

Model No. \_\_\_\_\_

Serial No. \_\_\_\_\_

### Register Your Product

The self-addressed PRODUCT REGISTRATION CARD should be filled in completely, signed and returned to the Frigidaire Company.

## Contents

**NOTE:** This Owner's Guide provides specific operating instructions for your model. Use the room air conditioner only as instructed in this Owner's Guide. These instructions are not meant to cover every possible condition and situation that may occur. Common sense and caution must be practiced when installing, operating, and maintaining any appliance.

2	Warranty
3	Product Registration
3	Normal Sounds
4	Important Safety Instructions
4	Energy Saving Ideas
5	Operation of Current Device, Description & Accessories
6-10	Air Conditioner Features
10	Care and Cleaning
11	Avoid Service Checklist

## Normal Sounds

Sound of Rushing Air  
At the front of the unit, you may hear the sound of rushing air being moved by fan.

High Pitched Chatter  
Today's high efficiency compressors may have a high pitched chatter during the cooling cycle.

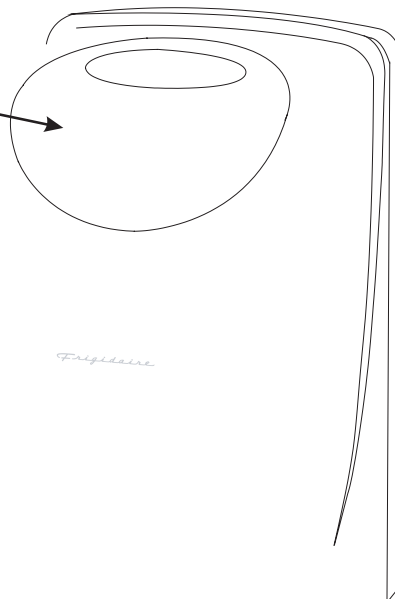

Gurgle/Hiss  
"Gurgling or hissing" noise may be heard due to refrigerant passing through evaporator during normal operation.

Vibration  
Unit may vibrate and make noise because of uneven floor.

## Important Safety Instructions

**NOTE** The power supply cord with this air conditioner contains a current detection device designed to reduce the risk of fire. Please refer to the section 'Operation of Current Device' for details. In the event that the power supply cord is damaged, it cannot be repaired it must be replaced with a cord from the Product Manufacturer.

**WARNING** Avoid fire hazard or electric shock. Do not use an extension cord or an adaptor plug. Do not remove any prong from the power cord.

### Grounding type wall receptacle

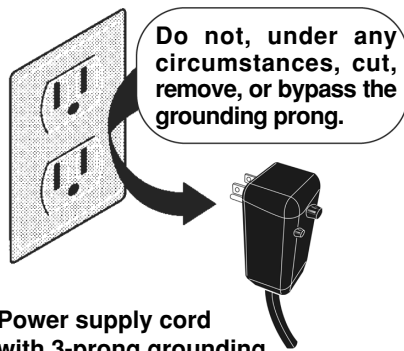

Power supply cord with 3-prong grounding plug and current detection device

Read all instructions before using this air conditioner.

### **WARNING** For Your Safety

Do not store or use gasoline or other flammable vapors and liquids in the vicinity of this or any other appliance. Read product labels for flammability and other warnings.

### **WARNING** Prevent Accidents

To reduce the risk of fire, electrical shock, or injury to persons when using your air conditioner, follow basic precautions, including the following:

- Be sure the electrical service is adequate for the model you have chosen. This information can be found on the serial plate, which is located on the side of the cabinet and behind the grille.
- If the air conditioner is to be installed in a window, you will probably want to clean both sides of the glass first. If the window is a triple-track type with a screen panel included, remove the screen completely before installation.
- Be sure the air conditioner has been securely and correctly installed according to the separate installation instructions provided with this manual. Save this manual and the installation instructions for possible future use in removing or reinstalling this unit.
- When handling the air conditioner, be careful to avoid cuts from sharp metal fins on front and rear coils.
- Do not cover appliance with clothes or any other objects.

### **WARNING** Electrical Information

The complete electrical rating of your new room air conditioner is stated on the serial plate. Refer to the rating when checking the electrical requirements.

- Be sure the air conditioner is properly grounded. To minimize shock and fire hazards, proper grounding is important. The power cord is equipped with a three-prong grounding plug for protection against shock hazards.
- Your air conditioner must be used in a properly grounded wall receptacle. If the wall receptacle you intend to use is not adequately grounded or protected by a time delay fuse or circuit breaker, have a qualified electrician install the proper receptacle.
- Do not run air conditioner with outside protective cover in place. This could result in mechanical damage within the air conditioner.
- **Do not use an extension cord or an adapter plug.**

## Energy Saving Ideas



- **Do not block air flow inside with blinds, curtains or furniture; or outside with shrubs, enclosures, or other buildings.**
- The capacity of the room air conditioner must fit the room size for efficient and satisfactory operation.
- Install the room air conditioner on the shady side of your home. A window that faces north is best because it is shaded most of the day.
- Close the fireplace damper, floor and wall registers so cool air does not escape up the chimney and into the duct work.
- Keep blinds and drapes in other windows closed during the sunniest part of the day.
- Clean the air filter as recommended in the section "Care and Cleaning."
- Proper insulation and water stripping in your home will help keep warm air out and cool air in.
- External house shading with trees, plants or awnings will help reduce the air conditioner's work load.
- Operate heat producing appliances such as ranges, washers, dryers and dishwashers during the coolest part of the day.

## Operation of Current Device

**⚠ WARNING**  
SAFETY INST

- The power supply  
power supply
1. Plug in the
  2. The power
  3. Press the f
  4. The power
- cated a

**NOTES**

- Do not use
  - Always use
  - The power
  - If power su
- it can be  
the pr

## Unit Description

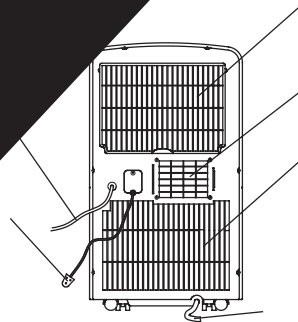

REAR VIEW

Fig.1

## Accessories Included

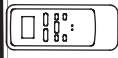
PART NO.:	PART NAME:	QTY.:
	EXHAUST ADAPTOR & FLEXIBLE DUCTING	1
	WINDOW ADAPTOR	
	WINDOW SLIDING KIT	
	WALL PLUG	
	SCREWS	
	ALKALINE BATTERIES	
	REMOTE CONTROL	
	WATER PUMP	

Check all the accessories are included in the installation instructions for



# Air Conditioner Features

## CONTROL PANEL

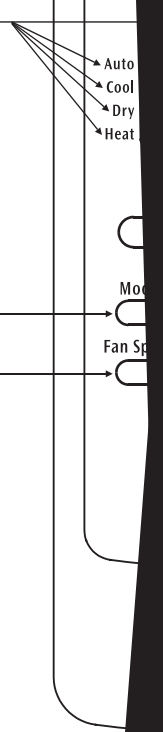
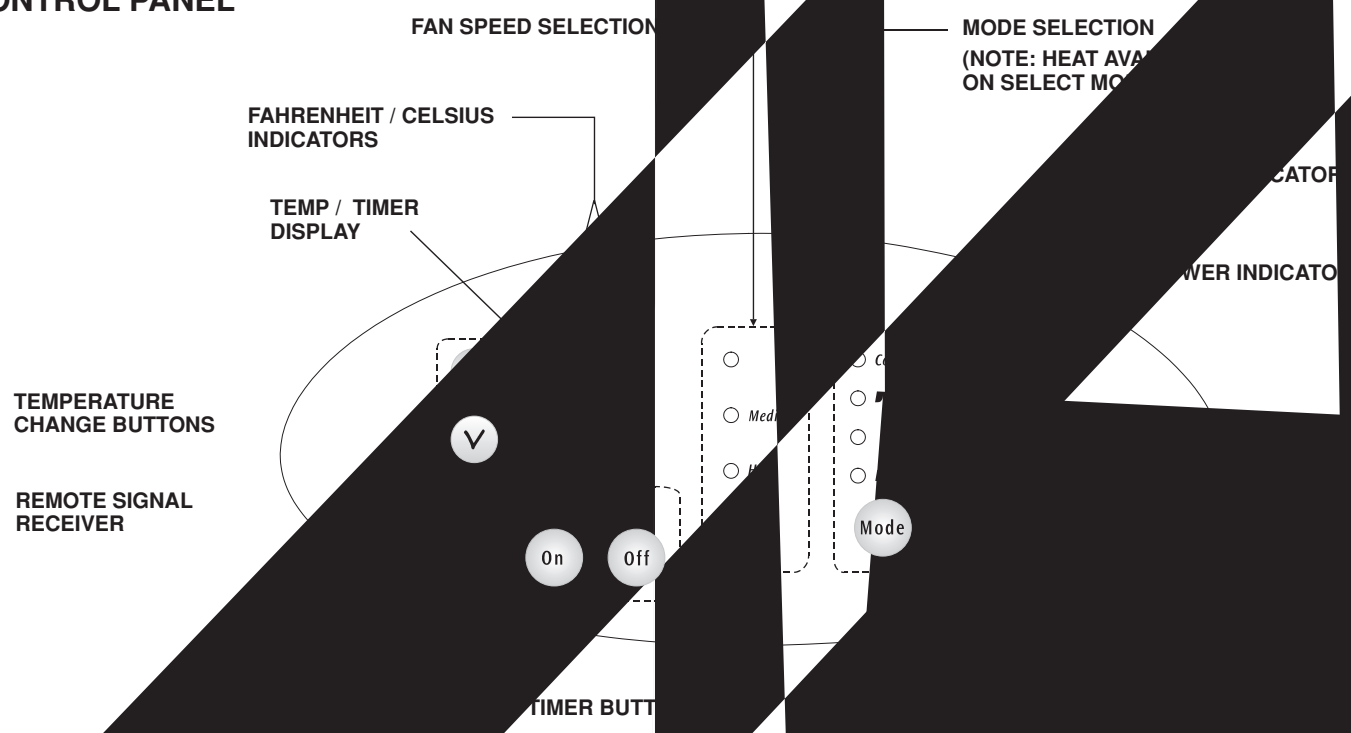

# Air Conditioner Features

(continued)

## EXHAUSTING HOT AIR

In the COOLING Mode the appliance must be placed close to a window or opening so that the warm exhaust air can be ducted outside.

First position unit on a flat floor and make sure there's a minimum of 12" clearance around the unit, and is within the vicinity of a single circuit outlet.

Attach the exhaust adaptor to the back of the unit by placing the hinge into the slot, and then locate the right side into the toothed slots. Finally push the hose connector downwards to secure. (Fig. 5)

Place the Flexible Duct onto the exhaust adaptor. (Fig. 6)

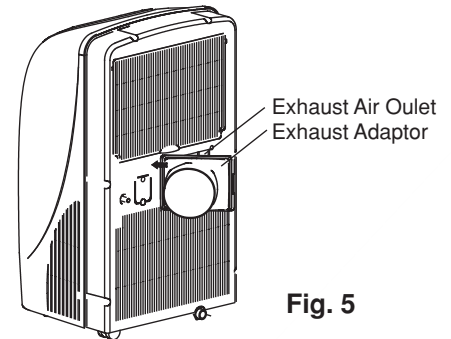

Fig. 5

## WINDOW DISCHARGE

- Place the window adaptor at the other end of the exhaust hose. Affix this end into the window slider kit and seal. (Fig. 7a & b)

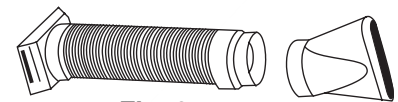
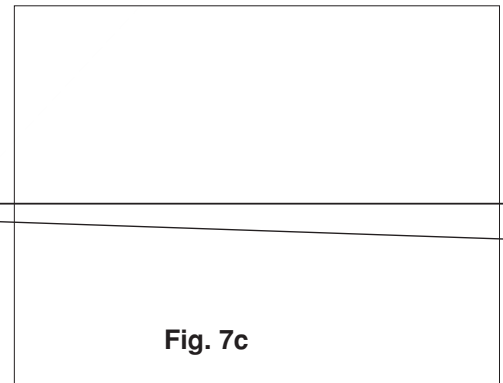
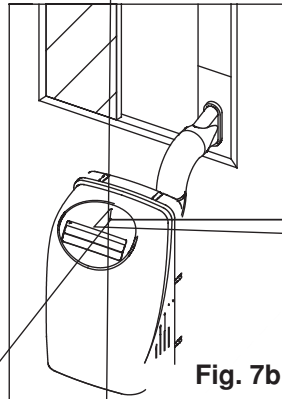
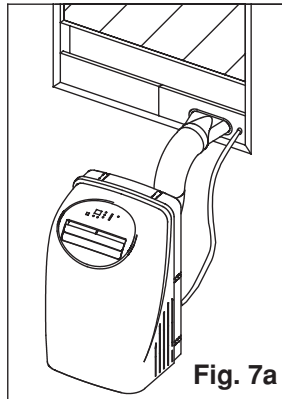
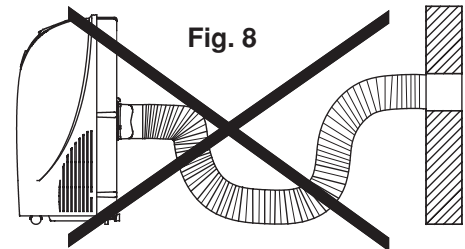

Fig. 6



## WALL DISCHARGE

- Mount wall adaptor directly over correctly installed duct to outside. (This usually includes aluminum wall ducting & an outside cover. See your hardware specialist for correct installation.)
- Use wall plugs & screws to secure. (Fig. 7c)
- Attach hose duct to wall adaptor.



The hose can be extended from its original length of 20" up to 80", but it is best to keep the length to the minimum required. Also make sure that the hose does not have any sharp bends or sags. (Fig. 8)

Next place the water pump drain hose on the end of the spigot. (Fig. 9)

Locate the open end either through the rubber grommet in the window slider kit so it can discharge out through the window, or in a suitable discharge drain. There is also provision for continuous drainage. Refer to the drainage section.

Power cord

Cover supplied must be removed

Water pump drain hose

Fig. 9

## Air Conditioner Features

(continued)

---

### COOLING MODE:

**In this mode the exhaust adaptor hose MUST be used.**

1. Press the MODE button until the “Cool” indicator lights.
2. Press the “^ v” Temp buttons for desired setting.
3. Press the FAN button for desired fan speed.

---

### HEATING MODE: (on select models)

**In this mode you do not need to use the exhaust adaptor hose.**

1. Press the MODE button until the “Heat” indicator lights.
2. Press the “^ v” Temp buttons up or down for the desired heat setting.
3. Press the FAN button for the desired fan speed.

---

### DRY MODE:

**In this mode you do not need to use the exhaust adaptor hose, BUT the water collected must be discharged. See Drainage Section.**

1. Press the MODE button until the “Dry” indicator lights.
2. The fan will run at a fixed speed and the display will go dark.
3. Keep doors & windows closed for best effect.

---

### FAN MODE:

**In this mode there is no requirement to use the exhaust hose or drainage hose. However, if you require stale or smokey air to be removed from the room, hook up the duct accessories as described in the “EXHAUSTING HOT AIR” section.**

1. Press the MODE button until the “Fan” indicator lights.
2. Press the FAN button to choose the desired fan speed.
3. The fan will run at the selected speed and the display will go dark.

---

### TIMER OPERATION:

#### **To start unit at a pre-determined time:**

Make sure that the appliance is in the same mode you will need when it turns back on. Then turn the unit off.

Press the “Timer On” button. The display will read “0.00”

Pressing the “Timer On” button will change the time in half-hour increments up to 10 hours, then full hour increments up to 24 hours. The appliance will switch on after the allotted time. To cancel at any point simply adjust the “Timer On” button to 0.00.

#### **To stop unit at a pre-determined time:**

The appliance must first be operating in the selected mode.

Press the “Timer Off” button. The display will read “0.00”

Pressing the “Timer Off” button will change the time in half-hour increments up to 10 hours, then full hour increments up to 24 hours. The appliance will switch off after the allotted time. To cancel at any point simply adjust the “Timer Off” button to 0.00.

#### **To Start/Stop and to Stop/Start**

The appliance can be programmed to do either. Just follow the instructions above in the order that you require. When programmed, you will see both timer indicators lit.

---

### TEMPERATURE DISPLAY:

The display can be changed to read either Fahrenheit (°F), or Celsius (°C). To do this simply hold the “^ v” Temp buttons for three seconds.

**Note:** the remote can only display the temperature in Fahrenheit (°F).



# Air Conditioner Features

(continued)

## DRAINAGE:

In the Cool & Dry Modes, water will collect in the internal bucket and will need to be discharged.

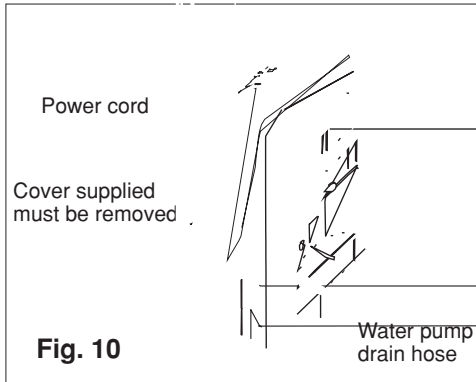

### Water Pump Drainage:

Remove the rubber cap from the spigot next to the power cord. Attach the rubber tubing supplied to the drainage spigot. Locate the open end either through the rubber grommet in the window slider kit so it can discharge out through the window, or in a suitable discharge drain. (Fig. 10)  
The pump will engage once the bucket is full.

### Continuous Drainage:

Remove the supplied rubber stopper from the hose connector. Screw a suitable length of hose onto this connector. Place the open end into a suitable drain making sure there are no kinks in the hose. (Fig. 11)

### Bucket Full Indicator:

This may illuminate if the drainage methods above are not used or there are blockages within the drain hoses. If no drain hose method can be used, wheel the unit to a suitable drain or outside, and then remove the continuous drain stopper to let the internal bucket drain. If hose drainage is being used and no blockages or kinks can be found then wheel the unit to a drainage point outside and drain as described above. (Fig. 12)  
Replace the stopper when drained.

Power cord

Continuous drain hose

BUCKET FULL INDICATOR

**Fig. 11**

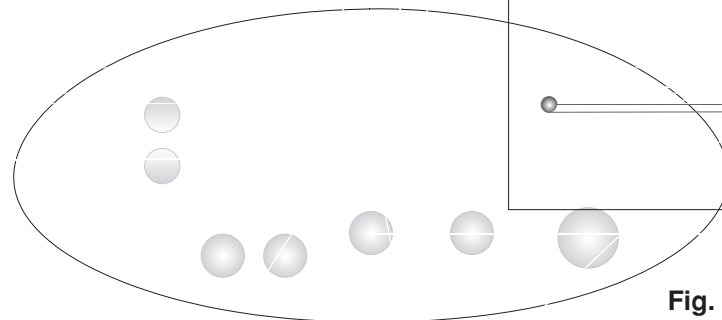

## REMOTE CONTROL OPERATION:

The remote control operates the unit in the same way as the control panel buttons with the exceptions noted below:

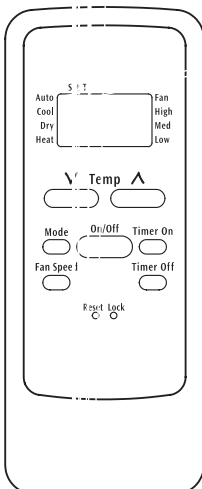

### AUTO FUNCTION:

The top left selection is an AUTO setting that will enable the appliance to determine the best mode selection against the temperature you have set. It will then run at high fan speed until the room is at the required setting, then the fan will slow down to keep the temperature level.

If the mode is not comfortable, the desired mode can be selected manually.

**Always have the exhaust hose attached in this mode.**

The RESET button is depressed when you want to return to the initial factory settings. The LOCK button is depressed to lock the keypad so the settings cannot be changed. The key symbol will appear in the display for the remote. Depress again to release.

Use a small pin to depress these buttons.

The remote can only display the set temperature in Fahrenheit. If you need to set the room temperature in Celsius, use the control panel on the unit.

## Air Conditioner Features

(continued)

### ADDITIONAL THINGS YOU SHOULD KNOW

Now that you have mastered the operating procedure, here are more features in your control that you should become familiar with.

- The “Cool” circuit has an automatic 3 minute time delayed start if the unit is turned off and on quickly. This prevents overheating of the compressor and possible circuit breaker tripping. The fan will continue to run during this time.
- The control will maintain the set temperature within 2°F, between 60°F and 90°F (16°C and 32°C).
- The control is capable of displaying temperature in degrees Fahrenheit or degrees Celsius. To convert from one to the other and back, press and hold the “TEMP” Up (  $\wedge$  ) and Down (  $\vee$  ) buttons together for 3 seconds.

## CARE & CLEANING

Clean your air conditioner occasionally to keep it looking new. **Be sure to unplug the unit before cleaning to prevent shock or fire hazards.**

### Air Filter Cleaning

The air filter should be checked at least once a month to see if cleaning is necessary. Trapped particles in the filter can build up and cause an accumulation of frost on the cooling coils.

- Pull open the filter cover by grasping the handle at the bottom.
- Remove the filter.
- Wash the filter using liquid dishwashing detergent and warm water. Rinse filter thoroughly. Gently shake excess water from the filter. Be sure filter is thoroughly dry before replacing.
- Or, instead of washing you may vacuum the filter clean.

### Cabinet Cleaning

- Be sure to unplug the air conditioner to prevent shock or fire hazard. The cabinet and front may be dusted with an oil-free cloth or washed with a cloth dampened in a solution of warm water and mild liquid dishwashing detergent. Rinse thoroughly and wipe dry.
- Never use harsh cleaners, wax or polish on the cabinet front.
- Be sure to wring excess water from the cloth before wiping around the controls. Excess water in or around the controls may cause damage to the air conditioner.
- Plug in air conditioner.

### Winter Storage

If you plan to store the appliance during the winter, cover it with plastic or return it to its carton.

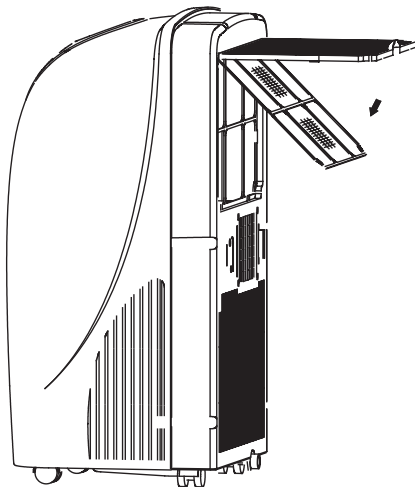



# Avoid Service Checklist

Before calling for service, review this list. It may save you time and expense. This list includes common occurrences that are not the result of defective workmanship or materials in this appliance.

OCCURRENCE	SOLUTION
<b>Air conditioner will not operate.</b>	<p>Wall plug disconnected. Push plug firmly into wall outlet.</p> <p>Plug Current Device Tripped. Press the RESET button.</p> <p>House fuse blown or circuit breaker tripped. Replace fuse with time delay type or reset circuit breaker.</p> <p>Control is OFF. Turn Control ON and set to desired setting.</p> <p>Bucket Full. Drain water as described in Drainage Section.</p> <p>Shut off in Heat mode. When the air outlet exceeds 158°F (70°C), the automatic heat protection engages. Remove any blockages and let appliance cool down.</p> <p>Room Temperature lower than the set temperature (Cool Mode). Reset the temperature.</p> <p>Room Temperature higher than the set temperature (Heat Mode). Reset the temperature.</p>
<b>Air from unit does not feel cold enough.</b>	<p>Room temperature below 60°F (16°C). Cooling may not occur until room temperature rises above 60°F (16°C).</p> <p>Temperature sensing element touching cold coil, located behind air filter. Straighten away from coil.</p> <p>Reset to a Lower temperature.</p> <p>Compressor shut-off by changing modes. Wait approximately 3 minutes and listen for compressor to restart when set in the COOL mode.</p>
<b>Air conditioner cooling, but room is too warm - ice forming on cooling coil behind rear cover.</b>	<p>Outdoor temperature below 60°F (18°C). To defrost the coil, set FAN ONLY Mode.</p> <p>Air filter may be dirty. Clean filter. Refer to Care and Cleaning section. To defrost, set to FAN ONLY Mode.</p> <p>Temperature is set too Low for night-time cooling. To defrost the coil, set to FAN ONLY Mode. Then, set Temperature to a Higher setting.</p> <p>Exhaust duct not connected or blocked. See EXHAUSTING HOT AIR Section.</p>
<b>Air conditioner cooling, but room is too warm - NO ice forming on cooling coil behind decorative front.</b>	<p>Dirty air filter - air restricted. Clean air filter. Refer to Care and Cleaning section.</p> <p>Temperature is set too high. Set temperature to a lower setting.</p> <p>Air directional louvers positioned improperly. Position louvers for better air distribution.</p> <p>Front of unit is blocked by drapes, blinds, furniture, etc. - restricts air distribution. Clear blockage in front of unit.</p> <p>Doors, windows, registers, etc. open - cold air escapes. Close doors, windows, registers, etc.</p> <p>Unit recently turned on in hot room. Allow additional time to remove "stored heat" from walls, ceiling, floor and furniture.</p>
<b>Air conditioner turns on and off rapidly.</b>	<p>Dirty air filter - air restricted. Clean air filter.</p> <p>Outside temperature extremely hot. Set FAN speed to a faster setting to bring air past cooling coils more frequently.</p>
<b>Noise when unit is cooling.</b>	<p>Air movement sound. This is normal. If too loud, set to a slower FAN setting.</p> <p>Vibraion from uneven floor. Move or support appliance correctly on even surface.</p>
<b>Room Too Cold.</b>	Set temperature too low. Increase set temperature.
<b>Room Too Hot.</b>	Set temperature too high. Lower setting.

## Free Manuals Download Website

<http://myh66.com>

<http://usermanuals.us>

<http://www.somanuals.com>

<http://www.4manuals.cc>

<http://www.manual-lib.com>

<http://www.404manual.com>

<http://www.luxmanual.com>

<http://aubethermostatmanual.com>

Golf course search by state

<http://golfingnear.com>

Email search by domain

<http://emailbydomain.com>

Auto manuals search

<http://auto.somanuals.com>

TV manuals search

<http://tv.somanuals.com>