

FRIGIDAIRE

All about the

Use & Care

of your Microwave Oven



TABLE OF CONTENTS

WELCOME & CONGRATULATION	2	SENSOR COOKING	14
IMPORTANT SAFETY INSTRUCTIONS.....	2	CONVECTION COOKING	18
PART NAMES	8	CONVENIENT FEATURES.....	23
BEFORE OPERATING	10	CLEANING AND CARE.....	26
MANUAL COOKING.....	10	SERVICE CALL CHECK	31
AUTO COOKING.....	13	SPECIFICATIONS.....	31
		WARRANTY.....	32

WELCOME & CONGRATULATIONS

Questions?

1-800-944-9044

(United States)

1-800-265-8352

(Canada)

Please attach sales receipt here for future reference.

Congratulations on your purchase of a new microwave oven! At **Electrolux Home Products**, we are very proud of our product and are completely committed to providing you with the best service possible. Your satisfaction is our number one priority.

We know you'll enjoy your new microwave oven and **Thank You** for choosing our product. We hope you consider us for future purchases.

PLEASE CAREFULLY READ AND SAVE THESE INSTRUCTIONS

This Use & Care Manual provides specific operating instructions for your model. Use your microwave oven only as instructed in this manual. These instructions are not meant to cover every possible condition and situation that may occur. Common sense and caution must be practiced when installing, operating and maintaining any appliance.

Please record your model and serial numbers below for future reference.

Model Number: _____

Serial Number: _____

Purchase Date: _____

NEED HELP?

Visit the Frigidaire Web Site at: <http://www.frigidaire.com>

Before you call for service, there are a few things you can do to help us serve you better.

Read this manual.

It contains instructions to help you use and maintain your microwave oven properly.

If you received a damaged Microwave Oven... immediately contact the dealer (or builder) that sold you the Microwave Oven.

Save time and money.

Check the section titled "Service Call Check". This section helps you solve common problems that might occur. If you do need service, you can relax knowing help is only a phone call away. A list of toll-free customer service numbers is included in the back of this manual. Or call Frigidaire Customer Services at 1-800-944-9044, 24 hours a day, 7 days a week.

IMPORTANT SAFETY INSTRUCTIONS

For your safety the information in this manual must be followed to minimize the risk of fire or explosion or to prevent property damage, personal injury or loss of life.

PRECAUTIONS TO AVOID POSSIBLE EXPOSURE TO EXCESSIVE MICROWAVE ENERGY

- (a) Do not attempt to operate this oven with the door open since open-door operation can result in harmful exposure to microwave energy. It is important not to defeat or tamper with the safety interlocks.
- (b) Do not place any object between the oven front face and the door or allow soil or cleaner residue to accumulate on sealing surfaces.
- (c) Do not operate the oven if it is damaged. It is particularly important that the oven door close properly and that there is no damage to the: (1) door (bent), (2) hinges and latches (broken or loosened), (3) door seals and sealing surfaces.
- (d) The oven should not be adjusted or repaired by anyone except properly qualified service personnel.

IMPORTANT SAFETY INSTRUCTIONS

Definitions

 This is the safety alert symbol. It is used to alert you to potential personal injury hazards. Obey all safety messages that follow this symbol to avoid possible injury or death.



WARNING

WARNING indicates a potentially hazardous situation which, if not avoided, could result in death or serious injury.



CAUTION

CAUTION indicates a potentially hazardous situation which, if not avoided, may result in minor or moderate injury.

READ ALL INFORMATION BEFORE USING



WARNING

To reduce the risk of fire, burns, electric shock, injury to persons, or exposure to excessive microwave energy when using your appliance, follow basic **precautions, including the following sections.**

- Read all instructions before using the appliance.
- Read and follow the specific **"PRECAUTIONS TO AVOID POSSIBLE EXPOSURE TO EXCESSIVE MICROWAVE ENERGY"** on page 2.
- This appliance must be grounded. Connect only to properly grounded outlet. See **"GROUNDING INSTRUCTIONS"** on page 5.
- Install or locate this appliance only in accordance with the provided installation instructions.
- Some products such as whole eggs and sealed containers—for example, closed glass jars—are able to explode and should not be heated in this microwave oven.
- Use this appliance only for its intended use as described in this manual. Do not use corrosive chemicals or vapors in this appliance. This type of microwave oven is specifically designed to heat, cook or dry food. It is not designed for industrial or laboratory use.
- As with any appliance, close supervision is necessary when used by children.
- Do not operate this appliance if it has a damaged cord or plug, if it is not working properly or if it has been damaged or dropped.
- This appliance should be serviced only by qualified service personnel. Contact nearest Electrolux Authorized Servicer for examination, repair or adjustment.
- Do not cover or block any openings on the appliance.
- Do not store or use this appliance outdoors. Do not use this product near water—for example, near a kitchen sink, in a wet basement or near a swimming pool, or similar locations.
- Do not immerse cord or plug in water.
- Keep cord away from heated surfaces.
- Do not let cord hang over edge of table or counter.
- See door surface cleaning instructions on page 26.

- To reduce the risk of fire in the microwave oven cavity:
 - **Do not overcook food. Carefully attend appliance when paper, plastic or other combustible materials are placed inside the microwave oven to facilitate cooking.**
 - Remove wire twist-ties from paper or plastic bags before placing bag in microwave oven.
 - **If materials inside the microwave oven ignite, keep microwave oven door closed, turn microwave oven off and disconnect the power cord or shut off power at the fuse or circuit breaker panel.**
 - Do not use the cavity for storage purposes. Do not leave paper products, cooking utensils or food in the cavity when not in use.
- Liquids, such as water, coffee or tea are able to be overheated beyond the boiling point without appearing to be boiling. Visible bubbling or boiling when the container is removed from the microwave oven is not always present. **THIS COULD RESULT IN VERY HOT LIQUIDS SUDDENLY BOILING OVER WHEN A SPOON OR OTHER UTENSIL IS INSERTED INTO THE LIQUID.**

To reduce the risk of injury to persons:

- Do not overheat the liquid.
- Stir the liquid both before and halfway through heating it.
- Do not use straight-sided containers with narrow necks. Use a wide-mouthed container.
- After heating, allow the container to stand in the microwave oven at least for 20 seconds before removing the container.
- Use extreme care when inserting a spoon or other utensil into the container.
- Clean ventilation openings and grease filters frequently. Grease should not be allowed to accumulate on ventilation openings, louver or grease filters.
- Use care when cleaning the louver and the grease filters. Corrosive cleaning agents, such as lye-based oven cleaners, may damage the louver and the grease filters.
- When flaming food under the hood, turn the fan on.
- This appliance is suitable for use above both gas and electric cooking equipment 36" wide or less.

SAVE THESE INSTRUCTIONS

IMPORTANT SAFETY INSTRUCTIONS

- When using the convection or combination cooking functions, both the outside and inside of the oven will become hot. Always use hot pads to remove containers of food and cooking accessories such as the oven shelf, round wire rack and glass tray.
- Do not clean with metal scouring pads. Pieces can burn off the pad and touch electrical parts involving risk of electric shock.
- *Thermometer*— Do not use regular cooking or oven thermometers when cooking by microwave or combination. The metal and mercury in these thermometers could cause *arcing* and possible damage to the oven. Do not use a thermometer in food you are microwaving unless the thermometer is designed or recommended for use in the microwave oven.



WARNING

If you see arcing, press the **Stop/Clear** button and correct the problem.

ARCING

Arcing is the microwave term for sparks in the oven. Arcing is caused by:

- The metal shelf not installed correctly so it touches the microwave wall.
- Metal or foil touching the side of the oven.
- Foil not molded to food (upturned edges act like antennas).
- Metal, such as twist-ties, poultry pins, or gold-rimmed dishes, in the microwave.
- Recycled paper towels containing small metal pieces being used in the microwave.

Federal Communications Commission Radio Frequency Interference Statement (U.S.A. Only)

This equipment generates and uses ISM frequency energy and if not installed and used properly, that is in strict accordance with the manufacturer's instructions, may cause interference to radio and television reception. It has been type tested and found to comply with limits for ISM Equipment pursuant to part 18 of FCC Rules, which are designed to provide reasonable protection against such interference in a residential installation.

However, there is no guarantee that interference will not occur in a particular installation. If this equipment does cause interference to radio or television reception, which can be determined by turning the equipment off and on, the user is encouraged to try to correct the interference by one or more of the following:

- Reorient the receiving antenna of the radio or television.
- Relocate the microwave oven with respect to the receiver.
- Move the microwave oven away from the receiver.
- Plug the microwave oven into a different outlet so that the microwave oven and the receiver are on different branch circuits.

The manufacturer is not responsible for any radio or television interference caused by unauthorized modification to this microwave oven. It is the responsibility of the user to correct such interference.

IMPORTANT SAFETY INSTRUCTIONS

UNPACKING AND EXAMINING YOUR MICROWAVE OVEN

Open the bottom of the carton, bend the carton flaps back and tilt the microwave oven over to rest on plastic foam pad. Lift carton off microwave oven and remove all packing materials, Installation Instructions, Wall Template, Top Template, Charcoal Filter, Turntable and Turntable Support. **SAVE THE CARTON AS IT MAY MAKE INSTALLATION EASIER.**

- Remove the feature sticker from the outside of the door, if there is one.
- **DO NOT REMOVE THE WAVEGUIDE COVER**, which is located on the ceiling in the microwave oven cavity. Check to see that there are Installation Instructions, Wall Template, Top Template and Charcoal Filter, which is used when recirculating is chosen. Read enclosures and **SAVE** the Use and Care Manual.

Check the microwave oven for any damage, such as misaligned or bent door, damaged door seals and sealing surfaces, broken or loose door hinges and latches and dents inside the cavity or on the door. If there is any damage, do not operate the microwave oven and contact your dealer or **ELECTROLUX SERVICER**. See Installation Instructions for more details.

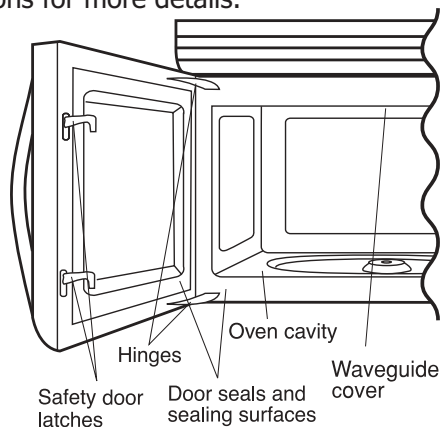

GROUNDING INSTRUCTIONS

This appliance must be grounded. This microwave oven is equipped with a cord having a grounding wire with a grounding plug. It must be plugged into a wall receptacle that is properly installed and grounded in accordance with the National Electrical Code and local codes and ordinances. In the event of an electrical short circuit, grounding reduces risk of electric shock by providing an escape wire for the electric current.

WARNING

Improper use of the grounding plug can result in a risk of electric shock.

Electrical Requirements

Check Installation Instructions for proper location for the power supply.

The electrical requirements are a 120 volt 60 Hz, AC only, 13.5 amp. or more protected electrical supply. It is recommended that a separate circuit serving only the microwave oven be provided.

The microwave oven is equipped with a 3-prong grounding plug. It must be plugged into a wall receptacle that is properly installed and grounded. **DO NOT UNDER ANY CIRCUMSTANCES CUT OR REMOVE THE GROUNDING PIN FROM THE PLUG. DO NOT USE AN EXTENSION CORD.**

If the power supply cord is too short, have a qualified electrician or serviceman install an outlet near the appliance. The Power Supply Cord and plug must be connected to a separate 120 Volt AC, 60 Hz, 13.5 Amp, or more branch circuit, single grounded receptacle. The receptacle should be located inside the cabinet directly above the Microwave Oven mounting location as shown in Figure 1.



NOTES

1. If you have any questions about the grounding or electrical instructions, consult a qualified electrician or service person.
2. Neither Electrolux nor the dealer can accept any liability for damage to the microwave oven or personal injury resulting from failure to observe the correct electrical connection procedures.

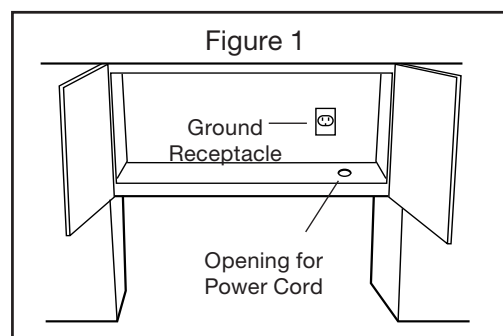
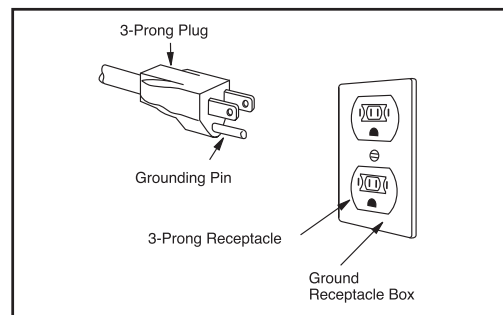

IMPORTANT SAFETY INSTRUCTIONS

ABOUT YOUR MICROWAVE OVEN

This Use and Care Manual is valuable: read it carefully and always save it for reference.

A good microwave cookbook is a valuable asset. Check it for microwave cooking principles, techniques, hints and recipes.

NEVER use the microwave oven without the turntable and support nor turn the turntable over so that a large dish could be placed in the microwave oven. The turntable will turn both clockwise and counterclockwise.

ALWAYS have food in the microwave oven when it is on to absorb the microwave energy.

When using the microwave oven at power levels below 100%, you may hear the magnetron cycling on and off. It is normal for the exterior of the microwave oven to be warm to the touch when cooking or reheating.

Condensation is a normal part of microwave cooking. Room humidity and the moisture in food will influence the amount of moisture that condenses in the microwave oven. Generally, covered foods will not cause as much condensation as uncovered ones. Ventilation openings must not be blocked.

The microwave oven is for food preparation only. It should not be used to dry clothes or newspapers.

Your microwave oven is rated 1000 watts by using the IEC Test Procedure. In using recipes or package directions, check food a minute or two before the minimum time and add time accordingly.

ABOUT MICROWAVE COOKING

- Arrange food carefully. Place thickest areas towards outside of dish.
- Watch cooking time. Cook for the shortest amount of time indicated and add more as needed. Food severely overcooked can smoke or ignite.
- Cover foods while cooking. Check recipe or cookbook for suggestions: paper towels, wax paper, microwave plastic wrap or a lid. Covers prevent spattering and help foods to cook evenly.
- Shield with small flat pieces of aluminum foil any thin areas of meat or poultry to prevent overcooking before dense, thick areas are cooked thoroughly.
- Stir foods from outside to center of dish once or twice during cooking, if possible.
- Turn foods over once during microwaving to speed cooking of such foods as chicken and hamburgers. Large items like roasts must be turned over at least once.
- Rearrange foods such as meatballs halfway through cooking both from top to bottom and from the center of the dish to the outside.
- Add standing time. Remove food from microwave oven and stir, if possible. Cover for standing time which allows the food to finish cooking without overcooking.
- Check for doneness. Look for signs indicating that cooking temperatures have been reached.

Doneness signs include:

- Food steams throughout, not just at edge.
- Center bottom of dish is very hot to the touch.
- Poultry thigh joints move easily.
- Meat and poultry show no pinkness.
- Fish is opaque and flakes easily with a fork.

ABOUT FOOD

FOOD	DO	DON'T
Eggs, sausages, nuts, seeds, fruits & vegetables	<ul style="list-style-type: none">• Puncture egg yolks before cooking to prevent "explosion".• Pierce skins of potatoes, apples, squash, hot dogs and sausages so that steam escapes.	<ul style="list-style-type: none">• Cook eggs in shells.• Reheat whole eggs.• Dry nuts or seeds in shells.
Popcorn	<ul style="list-style-type: none">• Use specially bagged popcorn for microwave cooking.• Listen while popping corn for the popping to slow to 1 or 2 seconds or use special popcorn pad.	<ul style="list-style-type: none">• Pop popcorn in regular brown bags or glass bowls.• Exceed maximum time on popcorn package.
Baby food	<ul style="list-style-type: none">• Transfer baby food to small dish and heat carefully, stirring often. Check temperature before serving.• Put nipples on bottles after heating and shake thoroughly. "Wrist" test before feeding.	<ul style="list-style-type: none">• Heat disposable bottles.• Heat bottles with nipples on.• Heat baby food in original jars.
General	<ul style="list-style-type: none">• Cut baked goods with filling after heating to release steam and avoid burns.• Stir liquids briskly before and after heating to avoid "eruption".• Use deep bowl, when cooking liquids or cereals, to prevent boilovers.	<ul style="list-style-type: none">• Heat or cook in closed glass jars or air tight containers.• Can in the microwave as harmful bacteria may not be destroyed.• Deep fat fry.• Dry wood, gourds, herbs or wet papers.

IMPORTANT SAFETY INSTRUCTIONS

ABOUT UTENSILS AND COVERINGS

It is not necessary to buy all new cookware. Many pieces already in your kitchen can be used successfully in your new microwave oven. Make sure the utensil does not touch the interior walls during cooking.

Use these utensils for safe microwave cooking and reheating:

- glass ceramic (Pyroceram®), such as Corningware®.
- heat-resistant glass (Pyrex®)
- microwave-safe plastics
- paper plates
- microwave-safe pottery, stoneware and porcelain
- browning dish (Do not exceed recommended preheating time. Follow manufacturer's directions.)

These items can be used for short time reheating of foods that have little fat or sugar in them:

- wood, straw, wicker

DO NOT USE

- metal pans and bakeware
- dishes with metallic trim
- non-heat-resistant glass
- non-microwave-safe plastics (margarine tubs)
- recycled paper products
- brown paper bags
- food storage bags
- metal twist-ties

Should you wish to check if a dish is safe for microwaving, place the empty dish in the microwave oven and microwave on HIGH for 30 seconds. A dish which becomes very hot should not be used.

The following coverings are ideal:

- Paper towels are good for covering foods for reheating and absorbing fat while cooking bacon.
- Wax paper can be used for cooking and reheating.
- Plastic wrap that is specially marked for microwave use can be used for cooking and reheating. DO NOT allow plastic wrap to touch food. Vent so steam can escape.
- Lids that are microwave-safe are a good choice because heat is kept near the food to hasten cooking.
- Microwave oven cooking bags are good for large meats or foods that need tenderizing. DO NOT use metal twist ties. Remember to slit bag so steam can escape.

How to use aluminum foil in your microwave oven:

- Small flat pieces of aluminum foil placed smoothly on the food can be used to shield areas that are either defrosting or cooking too quickly.
- Foil should not come closer than one inch to any surface of the microwave oven.

Should you have questions about utensils or coverings, check a good microwave cookbook or follow recipe suggestions.

ACCESSORIES There are many microwave accessories available for purchase. Evaluate carefully before you purchase so that they meet your needs. A microwave-safe thermometer will assist you in determining correct doneness and assure you that foods have been cooked to safe temperatures. Electrolux is not responsible for any damage to the microwave oven when accessories are used.

ABOUT CHILDREN AND THE MICROWAVE

Children below the age of 7 should use the microwave oven with a supervising person very near to them. Between the ages of 7 and 12, the supervising person should be in the same room.

As with any appliance, close supervision by an adult is necessary when used by children.

At no time should anyone be allowed to lean or swing on the microwave oven door.

Children should be taught all safety precautions: use potholders, remove coverings carefully, pay special attention to packages that crisp food because they may be extra hot.

Don't assume that because a child has mastered one cooking skill he/she can cook everything.

Children need to learn that the microwave oven is not a toy. See page 23 for Child Lock feature.

ABOUT SAFETY

- Check foods to see that they are cooked to the United States Department of Agriculture's recommended temperatures.

TEMP	FOOD
145°F - (63°C)	- For beef, lamb or veal cut into steaks, chops or roasts, fish
160°F - (71°C)	- For fresh pork, ground meat, seafood, egg dishes, frozen prepared food and beef, lamb or veal cut into steaks, chops or roasts
165°F - (74°C)	- For leftover, ready-to-reheat refrigerated, deli and carry out "fresh" food, whole chicken or turkey, chicken or turkey breasts and ground poultry used in chicken or turkey burgers

NOTE

Do not cook whole, stuffed poultry. Cook stuffing separately to 165°F.

To test for doneness, insert a meat thermometer in a thick or dense area away from fat or bone. NEVER leave the thermometer in the food during cooking, unless it is approved for microwave oven use.

- ALWAYS use potholders to prevent burns when handling utensils that are in contact with hot food. Enough heat from the food can transfer through utensils to cause skin burns.
- Avoid steam burns by directing steam away from the face and hands. Slowly lift the farthest edge of a dish's covering and carefully open popcorn and oven cooking bags away from the face.
- Stay near the microwave oven while it's in use and check cooking progress frequently so that there is no chance of overcooking food.
- NEVER use the cavity for storing cookbooks or other items.
- Select, store and handle food carefully to preserve its high quality and minimize the spread of foodborne bacteria.
- Keep waveguide cover clean. Food residue can cause arcing and/or fires.
- Use care when removing items from the microwave oven so that the utensil, your clothes or accessories do not touch the safety door latches.
- Keep aluminum foil used for shielding at least 1 inch away from walls, ceiling and door.

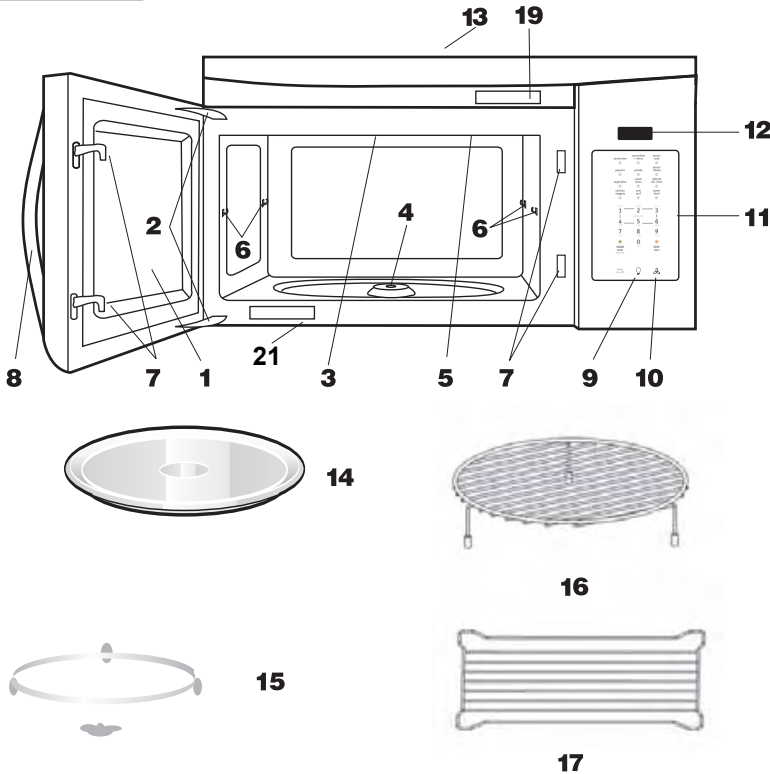

PART NAMES

FRONT VIEW

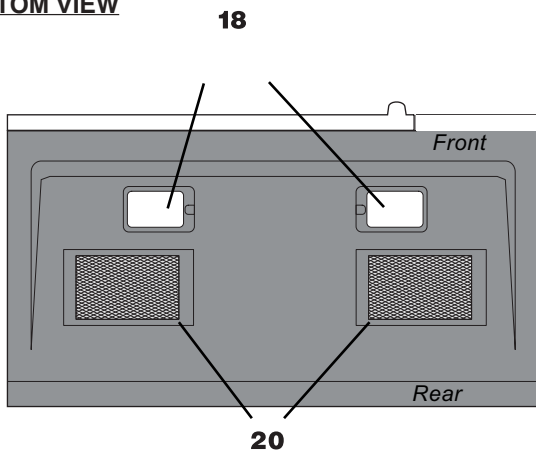

BOTTOM VIEW



- 1 Microwave oven door with see-through window
- 2 Door hinges
- 3 Waveguide cover:
DO NOT REMOVE.
- 4 Turntable motor shaft
- 5 Microwave oven light
It will light when microwave oven is operating or door is open.
- 6 Rack holders
- 7 Safety door latches
The microwave oven will not operate unless the door is securely closed.
- 8 Handle
- 9 Light on/off pad 
Press the **light on/off** pad once for on, twice for off.
- 10 Vent hi/lo/off pad 
Press the **vent hi/lo/off** pad once for high speed, twice for low speed and three times to turn off the fan.
- 11 Auto-Touch control panel
- 12 Time display: Digital display, 99 minutes, 99 seconds
- 13 Ventilation openings
- 14 Removable turntable
The turntable will rotate clockwise or counter-clockwise. Only remove for cleaning.
- 15 Removable turntable support
First, carefully place the turntable support in the motor shaft in the center of the microwave oven floor. Then, place the turntable on the turntable support securely.
- 16 Round wire rack (use in convection and combination cooking on the removable turntable)
- 17 Shelf (use in microwave cooking)
- 18 Light cover
- 19 Menu label
- 20 Grease filters
- 21 Rating label

CONTROL PANEL

The 7-digit Interactive Display spells out operating steps and shows cooking hints.

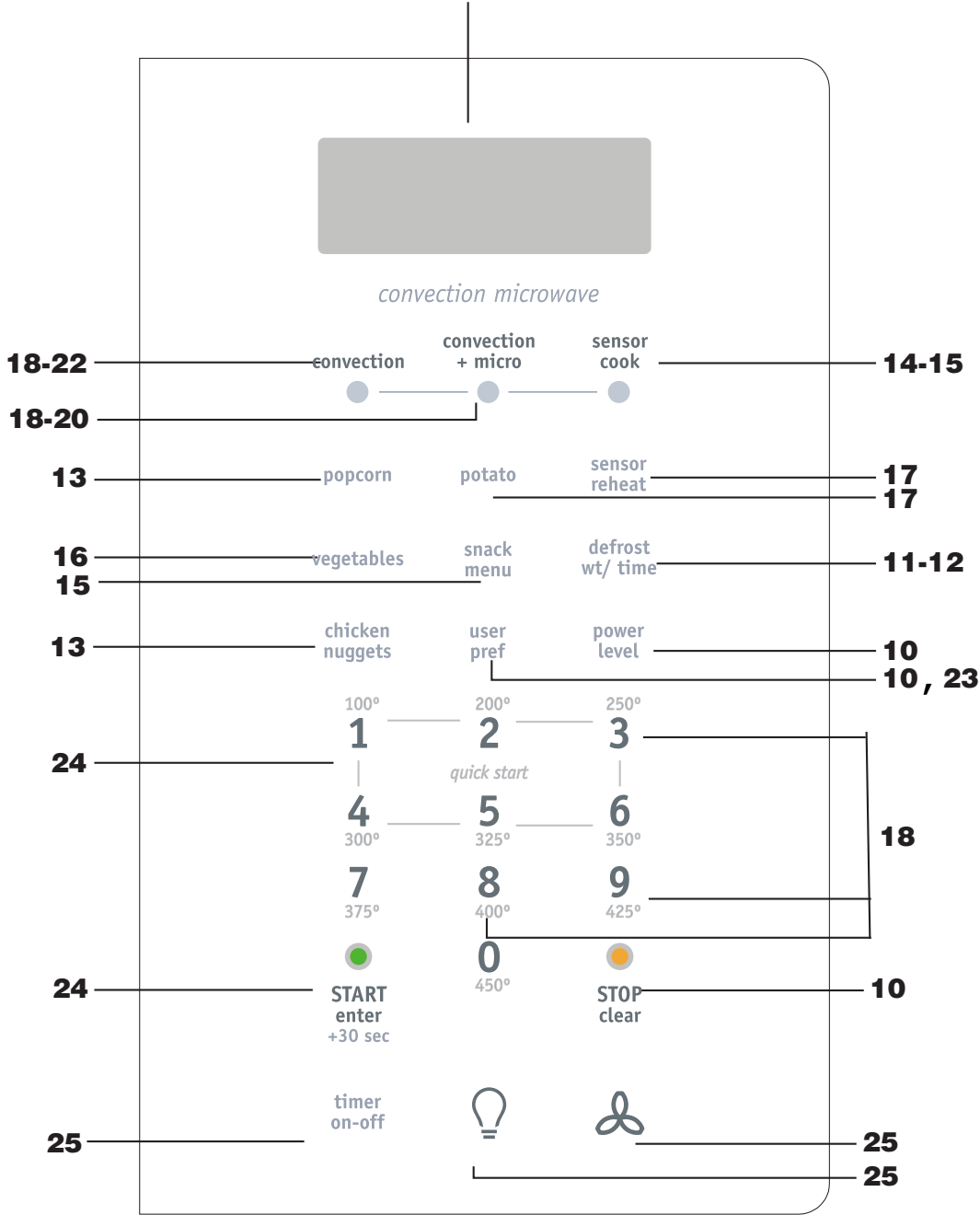

Number next to the control panel illustration indicates pages on which there are feature descriptions and usage information.

NOTE







When a pad is pressed, an audible signal will be heard which confirms the pad has been pressed.

BEFORE OPERATING

- Before operating your new oven make sure you read and understand this Use and Care Guide completely.
- Before the Over the Range Microwave Oven can be used, follow these procedures:
 1. Plug in the oven. Close the door. The oven display will show *ENJOY YOUR OVEN PRESS CLEAR*.
 2. Press the **STOP clear** pad. will appear.
 3. Set clock. See below.

To Set the Clock

- Suppose you want to enter the correct time of day 12:30 (A.M or P.M.).

Step	Press
1. Press the user pref pad.	
2. Press number 1.	
3. Enter the correct time of day by pressing the numbers in sequence.	   
4. Press the START enter +30 sec pad.	

This is a 12 hour clock. If you attempt to enter an incorrect clock time, *ERROR* will appear in the display. Press the **STOP clear** pad and re-set the clock.

NOTE

Your Over the Range Microwave Oven can be programmed with the door open except for **+30 sec**

STOP clear

Press the **STOP clear** to:





1. Erase if you make a mistake during programming.
2. Cancel timer and the signal after cooking.
3. Stop the oven temporarily during cooking.
4. Return the time of day to the display.
5. Cancel a program during cooking, press twice.

MANUAL COOKING

Time Cooking

Your Over the Range Microwave Oven can be programmed for 99 minutes 99 seconds (99 :99). Always enter the seconds after the minutes, even if they are both zeros.

- Suppose you want to cook for 5 minutes at 100%.

Step	Press
1. Enter cooking time. (The first number should be entered in 2 seconds.)	  
2. Press the START enter +30 sec pad	

To Set Power Level

There are ten preset power levels.

Using lower power levels increases the cooking time which is recommended for foods such as cheese, milk and long slow cooking of meats. Consult cookbook or recipes for specific recommendations.

PRESS POWER LEVEL PAD NUMBER OF TIMES FOR DESIRED POWER	APPROXIMATE PERCENTAGE OF POWER	COMMON WORDS FOR POWER LEVELS
POWER LEVEL x 1	100%	High
POWER LEVEL x 2	90%	
POWER LEVEL x 3	80%	
POWER LEVEL x 4	70%	Medium High
POWER LEVEL x 5	60%	
POWER LEVEL x 6	50%	Medium
POWER LEVEL x 7	40%	
POWER LEVEL x 8	30%	Med Low/Defrost
POWER LEVEL x 9	20%	
POWER LEVEL x 10	10%	Low

Using the Round Wire Rack





The rack allows several foods to be cooked or reheated by convection. Cook with SENSOR COOKING or AUTO COOKING without the rack. But Chicken Nuggets is one of AUTO COOKING, can use the rack, glassware or ceramic cookware, Do not use metal cookware. Allow plenty of space around and between the dishes. Pay close attention to the cooking and reheating progress. Reposition the foods and reverse them from the rack to turntable and/or stir them at least once during any cooking or reheating time. After cooking or reheating, stir if possible. Using a lower power level will assist in better cooking and reheating uniformity.

Avoid:

- Storing the rack in the microwave oven when not in use.
- Popping popcorn with the rack in the microwave oven.
- Using any browning dish on the rack.
- Using SENSOR COOKING and AUTO COOKING with the rack.
- Cooking directly on the rack—use microwave-safe cookware.

Setting Defrost by Weight

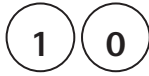
- **Suppose you want to defrost 1lb. of food with the default power level and cook time determined automatically:**

Step	Press
1. Press Defrost Wt/time pad once. The defrost icon ☼ will light in the display.	
2. Press number 1.	
3. Use the numeric pads to input weight of food to defrost in pounds (10 = 1lb.) You may enter any weight from 0.1 to 6.0lbs.	
4. Press START/enter/+30sec. pad.	

When the defrost time is complete, cooking completion signal will beep and END will appear in the display.







NOTE

The weight amount must be a valid entry for this feature to start. A valid weight entry is 0.1 to 6.0 pounds.

Setting Defrost by Time

- **Suppose you want to defrost food with the default 30% power level for 5 minutes:**

Step	Press
1. Press Defrost Wt/time pad once. The defrost icon ☼ will light in the display.	
2. Press number 2.	
3. Use the number pads to enter desired defrost time (defrost time may be set up to 99 minutes and 99 seconds).	
4. Press START/enter/+30sec. pad.	

When the defrost time is complete, cooking completion signal will beep and END will appear in the display.



NOTE

Power levels cannot be changed for both defrost (by weight or defrost (by time) because the defrost performance will be adversely affected.

Special notes for defrosting by time

- After pressing **START** key, the display will count down remaining defrost time. The oven will beep twice during the defrost cycle. At this time open the door and turn the food if needed and remove any portions that have already thawed. Touch the **START** key to resume the defrost cycle.
- When heating has finished you will hear beeps.

Defrosting tips

- When using the **defrost by weight** feature, the weight entered should always be pounds (valid entries are from 0.1 to 6.0 pounds).
- Use both **defrost weight** and **defrost time** features for raw food items only. Defrosting gives best results when food to be thawed is a minimum of 0°F (taken directly from a true freezer). If the food has been stored in a refrigerator-freezer that does not maintain a temperature of 5° F or below, always program a lower food weight or lower cook time to prevent cooking the food.
- If the frozen food is stored outside the freezer for up to 20 minutes, enter a reduced cook time or weight.
- The shape of the package will alter the defrosting time. Shallow rectangular food packets defrost more quickly than a deep frozen block of food.
- Separate pieces as they begin to defrost. Separated frozen pieces of food defrost better.
- Shield warm areas of food with small pieces of foil if they start to become warm.
- You may use small pieces of aluminum foil to shield food items like chicken wings, leg tips and fish tails, but do not allow the foil to touch the oven cavity walls when defrosting.

Defrosting suggestions

For best results, please read these suggestions when defrosting .

FOOD	AMOUNT	PROCEDURE
1. Ground Meat	0.5 - 3.0 lb 0.3 - 1.3 kg	Turn over and remove any thawed pieces after each stage. Let stand, covered, for 5 to 10 minutes.
2. Steaks/Chops/ Fish	0.5 - 4.0 lb 0.3 - 1.8 kg	After each stage, rearrange and if there are warm or thawed portions, shield with small flat pieces of aluminum foil. Remove any meat or fish that is almost defrosted. Let stand, covered, for 10 to 20 minutes.
3. Chicken Pieces	0.5 - 3.0 lb 0.3 - 1.3 kg	After each stage, rearrange pieces or remove portions should they become warm or thawed. Let stand, covered, for 10 to 20 minutes.
4. Roast	2.0 - 4.0 lb 1.0 - 1.8 kg	Start defrosting with fat side down. After each stage, turn roast over and shield the warm portions with aluminum foil. Let stand, covered, for 30 to 60 minutes.
5. Casserole	2 - 6 cups	After audible signal, stir if possible. At end, stir well and let stand, covered, for 5 to 10 minutes.
6. Soup	1 - 6 cups	After audible signal, stir if possible. At end, stir well and let stand, covered, for 5 to 10 minutes.

AUTO COOKING

Popcorn

⚠ CAUTION

DO NOT leave microwave oven unattended while popping corn.

The popcorn feature lets you pop 3 different commercially packaged microwave popcorn sized bags. Use the table below to determine the setting to use.

Amount	Press popcorn pad
3.50 oz. (default setting)	once
3.00 oz.	2 times
1.75 oz.	3 times

- Suppose you want to pop a 3.0 oz. bag of popcorn automatically.

Step	Press
------	-------

1. Press **Popcorn** pad (1, 2 or 3 times - refer to table above to change for bag size).

popcorn

2. Press **START** pad.

**START
enter
+30 sec**

Chicken Nuggets

- Suppose you want to heat 4 Oz- 24 Oz chicken nuggets.

Step	Press
1. Press the chicken nuggets pad.	chicken nuggets
2. Enter amount by pressing the number 4. Ex: 4.0 Oz chicken nuggets.	4
3. Press the START enter +30 sec pad.	START enter +30 sec

📌 NOTES

1. When 5.0 pound chicken nuggets is heated, press number 5 at Step 2.
2. Chicken nuggets use the round wire rack, glassware or ceramic cookware, Do not use metal cookware.

Chicken Nuggets chart

FOOD	AMOUNT	PROCEDURE
Chicken Nuggets	4 Oz- 24 Oz	Place frozen chicken nuggets on a flat plate allowing space between each. It is not necessary to cover them. When oven stops, rearrange and press the START enter +30 sec pad.

SENSOR COOKING

Sensor cooking has an electronic controlled sensor that detects the vapor (moisture and humidity) emitted from the food as it heats. The sensor adjusts the cooking times and power level for various foods and quantities automatically.

Menu label

sensor cook	sensor reheat	snacks
1 Frozen Entrees	1 Pasta	1 Frozen MW Pizza
2 Frozen Pizza	2 Soup	2 Hot Dogs
3 Ground Meat	3 Dinner Plate	3 Frozen Kids Meals
4 Rice		4 Meal in a cup
		5 Soup
		6 Beverage

Using Sensor Settings:

- After oven is plugged in, wait 2 minutes before using Sensor Settings.
- Be sure the exterior of the cooking container and the interior of the oven are dry. Wipe off any moisture with a dry cloth or paper towel.
- More or less food than the quantity listed in the chart should be cooked following the guidelines in any microwave cookbook.
- During the first part of SENSOR COOKING, food name will appear in the display. Do not open the oven door or press the **STOP clear** pad during this part of the cycle. The measurement of vapor will be interrupted. If this occurs, an error message will appear. To continue cooking, press the **STOP clear** pad and cook manually.

When the sensor detects the vapor emitted from the food, remainder of cooking time will appear. Door may be opened when remaining cooking time appears in the display. At this time, you may stir or season food, as desired.

- If the sensor does not detect vapor properly when cooking rice, the oven will turn off, and the correct time of day will be displayed. If the sensor does not detect vapor properly when cooking other foods, *ERROR* will be displayed, and the oven will turn off.
- Check food for temperature after cooking. If additional time is needed, continue to cook manually.

Covering Foods:

Some foods cook better when covered. Use the cover recommended in the food charts.

- Casserole lid.
- Plastic wrap: Use plastic wrap recommended for microwave cooking. Cover dish loosely; allow approximately 1/2 inch to remain uncovered to allow steam to escape. Plastic wrap should not touch food.
- Wax paper: Cover dish completely; fold excess wrap under dish to secure. If dish is wider than paper, overlap two pieces at least one inch to cover.

Be careful when removing any covering to allow steam to escape away from you.

SENSOR COOKING applies to the following selections: Sensor Cook, Snack Menu, Vegetables, Potato, Sensor Reheat.



NOTES for SENSOR COOKING

- The final cooking result will vary according to the food condition (e.g. initial temperature, shape, quality). Check food for temperature after cooking. If additional time is needed, continue to cook manually.
- When sensor detects the vapor emitted from the foods, manipulation message or remaining cooking time will be displayed.
- Stay near the oven while it's in use and check cooking progress frequently so that there is no chance of overcooking food.
- It is not necessary to enter amount.

Sensor Cook

There are 4 foods (Frozen Entrees, Frozen Pizza, Ground Meat and Rice) under the SENSOR COOK.

You can cook many foods by pressing the **sensor cook** pad and the food number. You don't need to calculate cooking time or power level.

- Suppose you want to cook Frozen Entrees.

Step	Press
1. Press the sensor cook pad, number 1 for Frozen Entrees.	
2. At end, follow the directions in the display.	
3. Press the START enter +30 sec pad.	



NOTES for SENSOR COOKING

- Check the *Cookware Tips* section for correct cookware when *Combination Cooking*
- Do not use metal cookware when *Combination Cooking*
- For best roasting and browning results, whole roasts should be cooked in a glass dish placed directly on the oven shelf.
- For foods that are too tall to fit in the oven, you can leave out the trivet. If necessary, you may take out the shelf and place the dish directly on the turntable.

SENSOR COOKING

Sensor Cook chart



FOOD (Initial temperature)	AMOUNT	PROCEDURE
1. Frozen Entrees (-18 °C)	8 - 24 oz 225 - 680 g	Use this pad for frozen, convenience foods. It will give satisfactory results for most brands. You may wish to try several and choose your favorite. Remove package from outer wrapping and follow package directions for covering. After cooking, let stand, covered for 1 to 3 minutes.
2. Frozen Pizza (-18 °C)	6 - 12 oz 170 - 340 g	Use for frozen microwave pizza. Remove from package and unwrap. Follow package directions for use of package and/or silver crisping disk.
3. Ground Meat (5 °C)	8 - 24 oz 225 - 680 g	Use this setting to cook ground beef or turkey as patties or in a casserole to be added to other ingredients. Place patties on a microwave-safe shelf and cover with wax paper. Place ground meat in a casserole and cover with wax paper or plastic wrap. When oven stops, turn patties over or stir meat in casserole to break up large pieces. Re-cover and press the START enter +30 sec pad. After cooking, let stand, covered, for 2 to 3 minutes.
4. Rice (Room temperature)	1 - 2 cups	Place rice into a deep casserole dish and add double quantity of water. Cover with lid or plastic wrap. After cooking, stir, cover and let stand 3 to 5 minutes or until all liquid has been absorbed.

Snack Menu

Snack Menu is for cooking/heating foods that take a short amount of time!

There are 6 foods (Frozen MW Pizza, Hot Dogs, Frozen Kid's Meal, Meal in a Cup, Soup, Beverage) under the SNACK MENU.

- Suppose you want to reheat a slice of frozen pizza with snack.

Step	Press
1. Press the snack menu pad and number 1 for pizza.	
2. Press the START enter +30 sec pad.	

Snack Menu chart



FOOD (Initial temperature)	AMOUNT	PROCEDURE
1. Frozen MW Pizza(-18 °C)	6 - 12 oz 170 - 340 g	Use for frozen microwave pizza. Remove from package and unwrap. Follow package directions for use of package and/or silver crisping disk.
2. Hot Dogs(5 °C)	8 - 24 oz	Place hot dog in bun. Wrap each with paper towel or napkin.
3. Frozen Kid's Meal (-18 °C)	6 - 8 oz 170 - 225 g	Use this pad for frozen, convenience foods. It will give satisfactory results for most brands. You may wish to try several and choose your favorite. Remove package from outer wrapping and follow package directions for covering. After cooking, let stand, covered for 1 to 3 minutes.
4. Meal in a Cup (5 °C)	1 cup	This setting is ideal for individual portions of canned food packed in a small microwaveable container, usually 6 to 8 ounces. Remove inner metal lid and replace outer microwaveable lid. After cooking, stir food and allow to stand 1 or 2 minutes.
5. Soup (5 °C)	1 - 4 cups (8 -32 oz)	Place in bowl or casserole. Cover with lid or plastic wrap. At end, stir, re-cover and let stand 1 to 3 minutes.
6. Beverage (5 °C)	1 - 2 cups	This setting is good for restoring a cool beverage to a better drinking temperature. Stir liquid briskly before and after heating to avoid "eruption".

SENSOR COOKING

Vegetables

There are 2 options (Frozen Vegetables, Fresh Vegetables) under the VEGETABLES.

- Suppose you want to cook fresh Vegetables .

Step	Press
1. Press the vegetables pad and number 2 for fresh Vegetables .	 
2. Press the START enter +30 sec pad.	

Vegetables chart

FOOD (Initial temperature)	AMOUNT	PROCEDURE
1. Frozen Vegetables (-18 °C)	4 - 24 oz 0.2 - 0.7 kg	Add no water. Cover with lid or plastic wrap. Press the vegetables pad and number 1 for fresh Vegetables . After cooking, stir and let stand, covered, for 3 minutes.
2. Fresh Vegetables (5 °C) Broccoli Brussels sprouts Cabbage Cauliflower (flowerets) Cauliflower (whole) Spinach Zucchini Baked apples Carrots, sliced Corn on cob Green beans Winter squash - diced - halves	4 - 24 oz 0.2 - 0.7 kg	Wash and place in casserole. Add no water if vegetables have just been washed. Cover with lid for tender vegetables. Use plastic wrap for tender-crisp vegetables. Press the vegetables pad and number 1 for fresh Vegetables ; After cooking, stir, if possible. Let stand, covered, for 2 to 5 minutes. Place in casserole. Add 1-4 tbsp. water. Cover with lid for tender vegetables. Use plastic wrap cover for tender-crisp vegetables. Press the vegetables pad and number 1 for fresh Vegetables . After cooking stir, if possible. Let stand, covered, for 2 to 5 minutes.

SENSOR COOKING

Potato

There is 1 option (potato) under the POTATO.

- Suppose you want to cook 2 potatoes.

Step	Press
1. Press the potato pad.	potato
2. Press START/enter/+30sec. pad.	START enter +30 sec

Potato chart

FOOD	AMOUNT	PROCEDURE
Potato (Room temperature)	1 - 4 pieces (230g/pc)	Pierce with fork in several places. Place on paper towel on turntable. After cooking, remove from oven and let stand wrapped in foil for 5 to 10 minutes.

Sensor Reheat

There is 3 options (Pasta,Soup,Dinner Plate) under the SENSOR REHEAT.

- Suppose you want to reheat soup.

Step	Press
1. Press the sensor reheat pad and number 2 for soup.	sensor reheat 2
2. Press START/enter/+30sec. pad.	START enter +30 sec

Sensor Reheat chart

FOOD	AMOUNT	PROCEDURE
(Initial temperature)		
Sensor Reheat		Place in dish or casserole slightly larger than amount to be reheated. Flatten, if possible. Cover with lid, plastic wrap or wax paper. Use covers such as plastic wrap or lids with larger quantities of more dense foods such as stews. After reheating, stir well, if possible. After stirring, re-cover and allow to stand 2 to 3 minutes. Foods should be very hot. If not, continue to heat with variable power and time.
1. Pasta (5 °C)	1 - 6 cups (8 - 24 oz)	Use this pad to reheat refrigerated canned or homemade pasta with sauce. For room temperature pastas, use Less option. Pasta without sauce double the quantity per setting. For example, measure 2 cups of cooked noodles and program for 1 cup. Cover with lid or plastic wrap. After cooking, stir and let stand, covered 2 to 3 minutes.
2. Soup (5 °C)	1 - 3 cups (8 - 24 oz)	Place in bowl or casserole. Cover with lid or plastic wrap. At end, stir, re-cover and let stand 1 to 3 minutes.
3. Dinner Plate (5 °C)	8 - 16 oz 225 - 450 g	Put dinner plate on a microwave safe plate . After heating, stir well.

CONVECTION COOKING

Convection Cooking

There are ten temperatures of convection: 100F, 200F, 250F, 300F, 325F, 350F, 375F, 400F, 425F, 450F.

Convection cooking uses a heating element to raise the temperature of the air inside the oven. Any oven temperature from 100°F to 450°F may be set. A fan gently circulates this heated air throughout the oven, over and around the food, producing golden brown exteriors and rich, moist interiors.

Because the heated air is kept constantly moving, not permitting a layer of cooler air to develop around the food, some foods cook faster than in regular oven cooking.

For Best Results...

Always use the round wire rack when convection cooking. Reduce package/recipe temperature 25°F for baked goods. The round wire rack is required for good air circulation and even browning.

See the *Cookware Tips* section (P21) for information on suggested cookware.

Using convection with preheating

- Suppose you want to cook food for 5 minutes at 250°F using convection with preheating

Step	Press
1. Press convection pad once.	convection
2. Press the temperature key to select the temperature you need. Do not enter cook time now. (The cook time will be entered later, after the oven is preheated.)	3 250°
3. Press Start/+30SEC. pad to start preheating. (When the oven is preheated, it will signal.)	START enter +30 sec
4. Place the food in the oven. Press the number keys to set cooking time (If you do not enter the cooking time within 20 minutes the oven will turn off automatically)	5 0 0 325° 450° 450°
5. press " Start/+30SEC. " to start cooking. When cooking is complete, the oven will signal and turn off.	START enter +30 sec

Using convection without preheating

- Suppose you want to cook food for 5 minutes at 250°F using convection without preheating

Step	Press
1. If your recipe does not require preheating, press the " convection " pad once.	convection

- Press the temperature key to select the temperature you need. **3**
250°
- Press "**convection**" to confirm the temperature. **convection**
- Press the number keys to set cooking time. **5 0 0**
325° 450° 450°
- Press the "**Start/+30SEC.**" pad to start the oven. **START**
enter
+30 sec

Combination Cooking

Combination Cooking offers the best features of microwave energy and convection cooking. Microwaves cook food fast and convection circulation of heated air browns foods beautifully.

For Best Results...

Always use the round wire rack when combination cooking. The round wire rack is required for good air circulation and even browning.

See the *Cookware Tips* section (P21) for information on suggested cookware.

Microwave+Convection Combination Cooking

- Suppose you want to cook food for 5 minutes using combination cooking.

Step	Press
1. Press convection +micro pad once.	convection +micro
2. Press the number keys to set cooking time.	5 0 0 325° 450° 450°
3. Press Start/+30SEC. pad to start cooking.	START enter +30 sec

NOTES

- Check the *Cookware Tips* section for correct cookware when *Combination Cooking*
- Do not use metal cookware when *Combination Cooking*
- For best roasting and browning results, whole roasts should be cooked in a glass dish placed directly on the oven shelf.
- For foods that are too tall to fit in the oven, you may take out the round wire rack and place the dish directly on the turntable.

CONVECTION COOKING

Convection Cooking

- Use the round wire rack during convection baking.
- Always pre-heat the oven before convection baking.
- Avoid opening the oven door during cooking – each time the door is opened the oven loses heat and this can cause uneven baking.

Biscuits and bread

TYPE	TEMPERATURE	TIME	NOTES
Biscuits	400°F	20-30 minutes	Canned refrigerated biscuits take 2 to 4 minutes less time.
Muffins	350°F	15-20 minutes	Remove from tin straight away and place on cooling rack.
Nut bread or fruit bread	350°F	55-70 minutes	
Bread	350°F	55-65 minutes	
Plain or sweet rolls	350°F	40-50 minutes	Lightly grease baking sheet.

Cakes

TYPE	TEMPERATURE	TIME	NOTES
Cheesecake	350°F	65-75 minutes	After baking open oven door slightly and leave cheesecake to stand in oven for 30 minutes
Coffee cake	350°F	30-40 minutes	
Cup cakes	350°F	20-30 minutes	
Fruit cake	300°F	85-95 minutes	
Gingerbread	350°F	40-45 minutes	

Combination Cooking

Combination cooking helps to brown and crisp foods.

TYPE	QUANTITY	TIME	NOTES
Beefburgers	4oz	16-19 minutes for two	Place on microwave-proof plate, drain fat and turn halfway through cooking.
Beef rump roast	1.0kg	Rare: 15-20 minutes Medium: 21-25 minutes Well done: 26-30 minutes	Place fat side down on low rack, season, shield if necessary After cooking, leave to stand for 15 minutes.
Lamb roast, rolled, boneless	1.0kg	Rare: 15-20 minutes Medium: 21-25 minutes Well done: 26-30 minutes	Place fat side down on low rack, brush with marinade and season, shield if necessary. After cooking, leave to stand for 15 minutes.
Pork	2 chops	Rare: 13-17 minutes Medium: 18-23 minutes Well done: 24-29 minutes	Place on high rack, brush with marinade and season. Cook until no longer pink or internal temperature reaches 170°F. Turn halfway through cooking. After cooking, cover with foil and leave to stand for 5 minutes.
Pork	4 chops	Rare: 15-19 minutes Medium: 20-25 minutes Well done: 26-32 minutes	Place on high rack, brush with marinade and season. Cook until no longer pink or internal temperature reaches 170°F. Turn halfway through cooking. After cooking, cover with foil and leave to stand for 5 minutes.
Pork loin roast, rolled, boneless	1.0kg	Rare: 20-25 minutes Medium: 26-30 minutes Well done: 30-35 minutes	Place fat side down on low rack, season, shield if necessary. After cooking, cover with foil and leave to stand for 15 minutes.
Chicken breasts	1 lb.	16-26 minutes	Wash and dry meat, remove skin, place thickest portion to outside on high rack.
Chicken boneless portions	1 lb.	13-24 minutes	Place on high rack, brush with butter and season as required. Turn halfway through cooking. Cook until no longer pink and juices run clear. After cooking, cover with foil and leave to stand for 3-5 minutes.
Chicken, whole	1.3kg	25 40 minutes	Wash and dry bird, place breast down on low rack, brush with butter and season as required. Turn and drain halfway through cooking. Cook until no longer pink and juices run clear. After cooking, cover with foil and leave to stand for 10 minutes. Temperature in thigh should be approx 185°F.

CONVECTION COOKING

Cookware Tips

Convection Cooking

Metal Pans are recommended for all types of baked products, but especially where browning or crusting is important.

Dark or dull finish metal pans are best for breads and pies because they absorb heat and produce crisper crust.

Shiny aluminum pans are better for cakes, cookies or muffins because these pans reflect heat and help produce a light tender crust.

Glass or Glass-Ceramic casserole or baking dishes are best suited for egg and cheese recipes due to the cleanability of glass.

Combination Cooking

Glass or Glass-Ceramic baking containers are recommended. Be sure not to use items with metal trim as it may cause arcing (sparking) with oven wall or oven shelf, damaging the cookware, the shelf or the oven.

Heat-Resistant Plastic microwave cookware (safe to 450°F) may be used, but it is not recommended for foods requiring crusting or all-around browning, because the plastic is a poor conductor of heat.

COOKWARE	MICROWAVE	CONVECTION	COMBINATION
<i>Heat-Resistant Glass, Glass-Ceramic (Pyrex®, Fire King®, Corning Ware®, etc.)</i>	Yes	Yes	Yes
<i>Metal</i>	No	Yes	No
<i>Non Heat-Resistant Glass</i>	No	No	No
<i>Microwave-Safe Plastics</i>	Yes	No	Yes
<i>Plastic Films and Wraps</i>	Yes	No	No
<i>Paper Products</i>	Yes	No	No
<i>Straw, Wicker and Wood</i>	Yes	No	No

*Use only microwave cookware that is safe to 450 °F.

CONVECTION COOKING

Select the best method of cooking

Use the following guide to select the best method of cooking. Specific recipes can be adapted to any method of cooking.

- ❶ — Best method
- ❷ — Alternate method
- N/R* — Not recommended

FOODS	MICROWAVE	COMBINATION	CONVECTION
Appetizers			
Dips and Spreads	❶	<i>N/R</i>	<i>N/R</i>
Pastry Snacks	❷	❶	❷
Beverages			
	❶	<i>N/R</i>	<i>N/R</i>
Sauces and Toppings			
	❶	<i>N/R</i>	<i>N/R</i>
Soups and Stews			
	❶	❷	<i>N/R</i>
Meats			
Defrosting	❶	<i>N/R</i>	<i>N/R</i>
Roasting	❷	❶	❷
Poultry			
Defrosting	❶	<i>N/R</i>	<i>N/R</i>
Roasting	❷	❶	❷
Fish and Seafood			
Defrosting	❶	<i>N/R</i>	<i>N/R</i>
Cooking	❶	❷	<i>N/R</i>
Casseroles			
	❷	❶	❷
Eggs and Cheese			
Scrambled, Omelets	❶	<i>N/R</i>	❷
Quiche, Souffle	❷	❷	❶
Vegetables , (fresh)			
	❶	<i>N/R</i>	<i>N/R</i>
Breads			
Quick	❷	❶	❷
Yeast	<i>N/R</i>	❷	❶
Muffins, Coffee Cake			
	❷	❶	❷
Desserts			
Cakes, Layer and Bundt	❷	❶	❷
Angel Food and Chiffon	<i>N/R</i>	<i>N/R</i>	❶
Custard and Pudding	❶	<i>N/R</i>	<i>N/R</i>
Bar Cookies	❷	❶	❷
Fruit	❶	<i>N/R</i>	<i>N/R</i>
Pies and Pastry	<i>N/R</i>	❷	❶
Candy	❶	<i>N/R</i>	<i>N/R</i>
Blanching Vegetables			
	❶	<i>N/R</i>	<i>N/R</i>
Frozen Convenience Foods			
	❶	❷	❷

CONVENIENT FEATURES

User Pref

User Pref provides 4 features that make using your oven easy because specific instructions are provided in the interactive display.

User Pref Label

user pref	
1	Clock
2	Child Lock
3	Auto Start
4	Buzzer On/ Off

1. Set the Clock

See page 10.

2. Child Lock







The Child Lock prevents unwanted oven operation such as by small children. The oven can be set so that the control panel is deactivated or locked. To set, press the **user pref** pad, the number 2 and then press the **START enter +30 sec** pad. If a pad be pressed, *LOCK ON* will appear in the display.







To cancel, press the **user pref** pad and the **START enter +30 sec** pad. Child Lock will not be canceled if other pads except the **START enter +30 sec** pad are pressed after pressing the **user pref** pad.

3. Auto Start

If you wish to program your oven to begin cooking automatically at a designated time of day, follow this procedure:

- Suppose you want to start cooking a stew for 20 minutes at 50% power level at 4:30. Before setting, check to make sure the clock is showing the correct time of day.

Step	Press
1. Press the user pref pad.	
2. Press number 3.	
3. Enter the start time. Ex : 4:30	  
4. Press the START enter +30 sec pad.	

Step	Press
5. Enter cooking time. Ex : 20 minutes	   
6. Press the power level pad six times for 50% power.	 x 6
7. Press the START enter +30 sec pad.	



NOTES

1. If the door is closed, buzzer will ring twice when the pre-set time arrives, then cooking will start automatically.
2. Auto Start can be used for manual cooking in conjunction with sequence cooking if clock is set.
3. Be sure to choose foods that can be left in the oven safely until the Auto Start time. Acorn or butternut squash are often a good choice.
4. If the electrical power supply to your microwave oven should be interrupted, reset the clock (see page 10) and follow the procedure above to set Auto Start.

4. Audible Signal Elimination

If you wish to have the oven operate with no audible signals, press the **user pref** pad, number 4 and the **START** pad.

To cancel and restore the audible signal, press the **user pref** pad, number 4 and the **START enter +30 sec** pad.





CONVENIENT FEATURES

Multiple Sequence Cooking

Your oven can be programmed for up to 2 automatic cooking sequences, switching from one power level setting to another automatically.

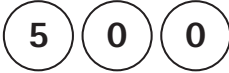
Sometimes cooking directions tell you to start on one power level and then change to a different power level. Your oven can do this automatically.

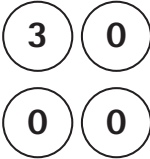
- Suppose you want to cook roast beef for 5 minutes at 100% and then continue to cook for 30 minutes at 50%.

Step	Press
1. Enter cooking time for 1st stage.	
2. Press the power level pad once for 100% power for 1st stage.	
3. Enter second cooking time for 2nd stage.	
4. Press the power level pad 6 times for 50% power for 2nd stage.	
5. Press the START enter +30 sec pad for 2nd stage.	

NOTE

If 100% is selected as the final sequence, it is not necessary to press the **power level** pad.

+30 Seconds

+30 seconds allows you to cook for 30 seconds at 100% by simply pressing the **START enter +30 sec** pad. You can also extend cooking time in multiples of 30 seconds by repeatedly pressing the **START enter +30 sec** pad until maximum 99 minutes 99 seconds during manual cooking.

- Suppose you want to heat a cup of soup for 30 seconds.

Step	Press
Press the START enter +30 sec pad.	

NOTES

- To use **+30 sec**, press the pad after cooking, closing the door, pressing the **STOP clear** pad or during cooking.
- +30 seconds cannot be used with SENSOR COOKING and Chicken Nuggets.

Quick Start

Quick start is very useful function to start to cook from 1 minute to 6 minutes by pressing number from 1 to 6 by pressing the **START enter +30 sec** pad.



- Suppose you want to cook 2 minutes at 100% power.

Step	Press
Press number 2.	

CONVENIENT FEATURES

Timer

- Suppose you want to time a 3-minute long distance phone call.

Step	Press
1. Press the timer on-off pad.	
2. Enter time.	
3. Press the timer on-off pad. The timer will count down.	



NOTES

- Timer** operates as a kitchen timer and cannot be used when the oven is operating.
- To cancel the timer, press the **STOP clear** pad once.

Demonstration Mode

When the oven is electrified and within one minute, to demonstrate, press the **popcorn** pad and hold for 6 seconds. *ENTER DEMO* will appear in the display. Cooking operations and specific special features can now be demonstrated with no power in the oven.

For example, press the **popcorn** pad and the display will show 3:28 and count down quickly to *END*.

To cancel, press the **popcorn** pad and hold for 6 seconds. If easier, unplug the oven from the electrical outlet and replug.

Light

Press the **light on/off** pad once for on, twice for off.

Fan

The fan will automatically start when heat rises from range surface units or burners. This protects the Over the Range Microwave Oven from excessive temperature rise. The fan will stay on until the temperature decreases. It cannot be turned off manually during this time.

For other uses, press the **vent hi/lo/off** pad once for high speed, twice for low speed and three times to turn off.

CLEANING AND CARE

Disconnect the power cord before cleaning or leave the door open to deactivate the oven during cleaning.

EXTERIOR

The outside surface is precoated steel and plastic. Clean the outside with mild soap and water; rinse and dry with a soft cloth. Do not use any type of household or abrasive cleaner.

DOOR

Wipe the window on both sides with a soft cloth to remove any spills or splatters. Metal parts will be easier to maintain if wiped frequently with a soft cloth. Avoid the use of spray and other harsh cleaners as they may stain, streak or dull the door surface.

EASY CARE™ STAINLESS STEEL (SOME MODELS)

Your microwave oven finish may be made with Easy Care™ Stainless Steel (some models). Clean the stainless with warm soapy water using a clean sponge or cloth. Rinse with clean water and dry with a soft clean cloth. DO NOT use ANY store bought cleaners like Stainless Steel cleaners or any other types of cleaners containing any abrasive, chlorides, chlorines or ammonia. It is recommended to use mild dish soap and water or a 50/50 solution of water and vinegar.

TOUCH CONTROL PANEL

Care should be taken in cleaning the touch control panel. If the control panel becomes soiled, open the microwave oven door before cleaning. Wipe the panel with a cloth dampened slightly with water only. Dry with a soft cloth. Do not scrub or use any sort of chemical cleaners. Close door and touch **Clear/Off**.

INTERIOR

Cleaning is easy because little heat is generated to the interior surfaces. To clean the interior surfaces, wipe with a soft cloth and warm water. DO NOT USE ABRASIVE OR HARSH CLEANERS OR SCOURING PADS. For heavier soil, use baking soda or a mild soap; rinse thoroughly with hot water. The round wire rack and shelf can be cleaned with hot soapy water, rinsed and dried.

WAVEGUIDE COVER

The waveguide cover is located on the ceiling in the microwave oven cavity. It is made from mica so requires special care. Keep the waveguide cover clean to assure good microwave oven performance. Carefully wipe with a damp cloth any food splatters from the surface of the cover immediately after they occur. Built-up splashes may

overheat and cause smoke or possibly catch fire. DO NOT REMOVE THE WAVEGUIDE COVER.

ODOR REMOVAL

Occasionally, a cooking odor may remain in the microwave oven. To remove, combine 1 cup water, grated peel and juice of 1 lemon and several whole cloves in a 2-cup glass measuring cup. Boil for several minutes using 100% power. Allow to set in microwave oven until cool. Wipe interior with a soft cloth.

TURNTABLE/TURNTABLE SUPPORT

The turntable and turntable support can be removed for easy cleaning. Wash them in mild, sudsy water; for stubborn stains use a mild cleanser and non-abrasive scouring sponge. They are also dishwasher-proof. Use upper round wire rack of dishwasher. The turntable motor shaft is not sealed, so excess water or spills should be wiped up immediately.

CLEANING AND CARE

Disconnect the power cord before cleaning or leave the door open to deactivate the oven during cleaning.

Cleaning the exhaust filters

The oven ventilation exhaust filters should be removed and cleaned often; generally at least once every month.

⚠ CAUTION

To avoid risk of personal injury or property damage, do not operate oven hood without filters properly in place.

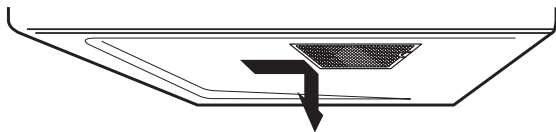
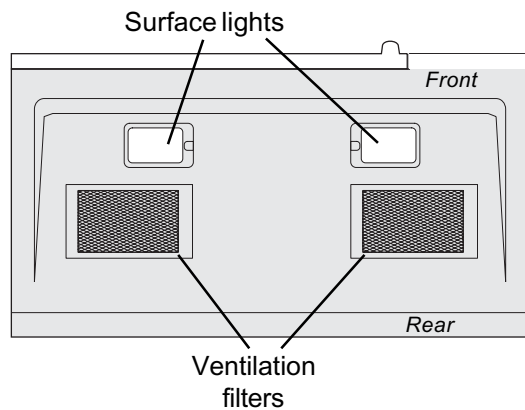

1. To remove the exhaust ventilation filters, slide the filter to the rear. Then pull filter downward and push to the other side. The filter will drop out. Repeat for the 2nd filter.

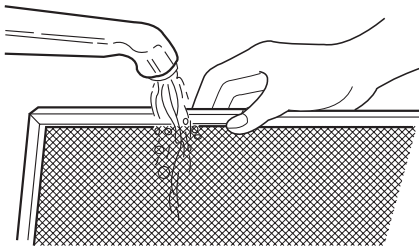

2. Soak the ventilation filters in hot water using a mild detergent. Rinse well and shake to dry or wash in a dishwasher. **Do not use ammonia. The aluminum on the filter will corrode and darken.**

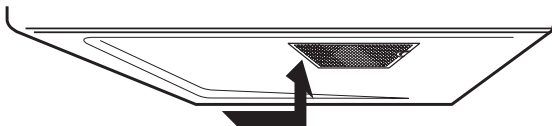

3. To reinstall the exhaust ventilation filter, slide it into the side slot, then push up and toward oven to lock. Reinstall the 2nd filter using the same procedure.

Surface light replacement

⚠ CAUTION

To avoid risk of personal injury or property damage, wear gloves when replacing the light bulbs.

1. Unplug the microwave oven or turn off power at the main circuit breaker.
2. Remove the bulb cover mounting screws at both light positions under the microwave.

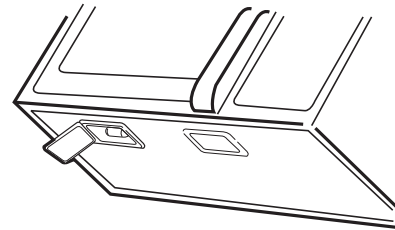

3. Replace bulb with 30 watt appliance bulb.
4. Re-install bulb cover and mounting screw.
5. Plug the microwave back into the power supply or turn the power back on at the main circuit breaker.

CLEANING AND CARE

Disconnect the power cord before cleaning or leave the door open to deactivate the oven during cleaning.

Charcoal filter replacement

Charcoal Filter installed in your microwave oven, is used for nonvented, recirculated installation. The filter should be changed every 6 to 12 months depending on use.

1. Disconnect power to the microwave oven at the circuit breaker panel or by unplugging.
2. Remove the vent grill mounting screws.
3. Pull the vent grill away from the unit.

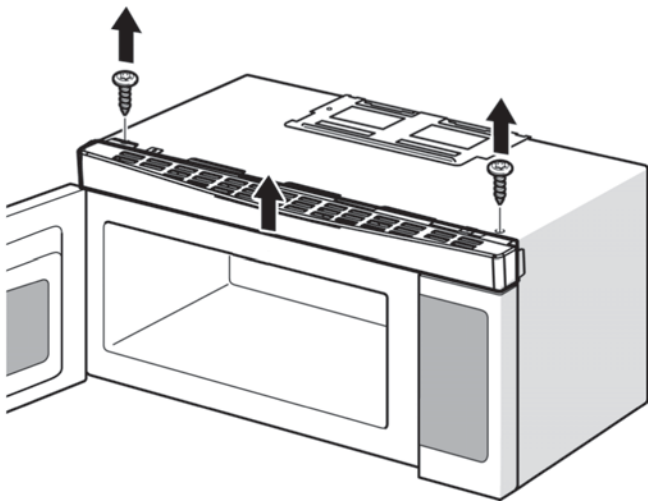

4. Remove the charcoal filter by pushing it inwards, then turn and pull it away from the unit.

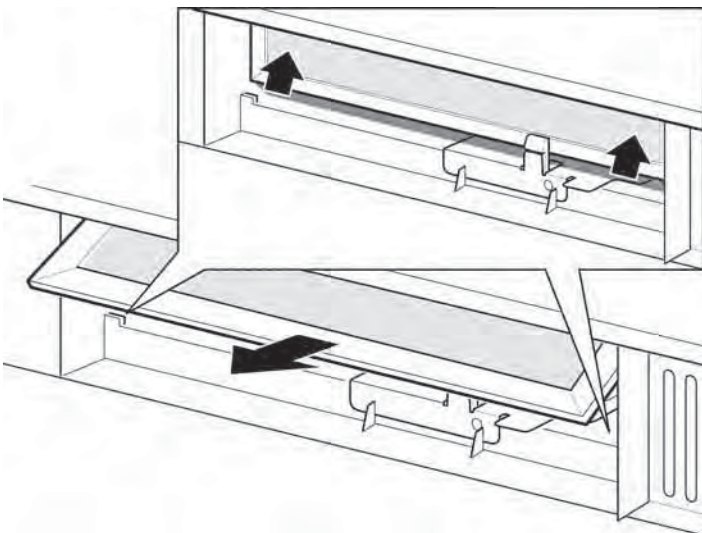

Oven light replacement

Remove the vent grill per instructions 1-4 above and charcoal filter, if used.

1. Open light cover located behind filter mounting by carefully pulling up on the front edge.

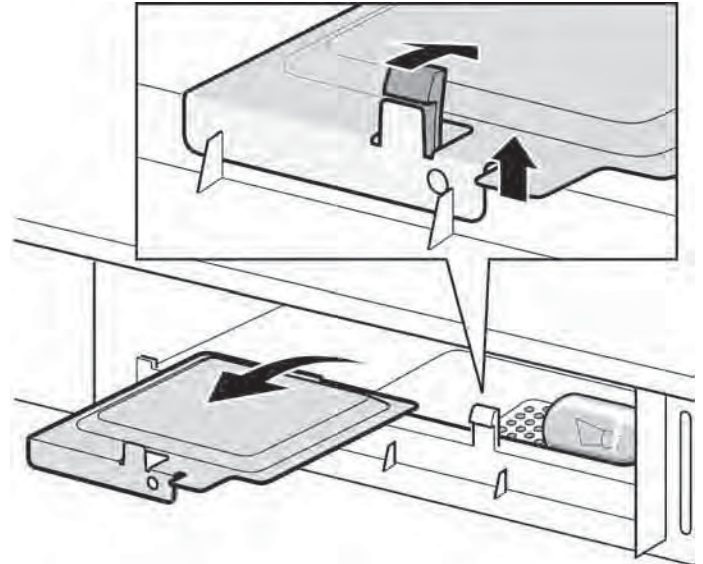

2. Remove old light bulb and replace only with equivalent 30 watt bulb available from parts distributor. Bulbs are also available at most hardware stores or lighting centers.

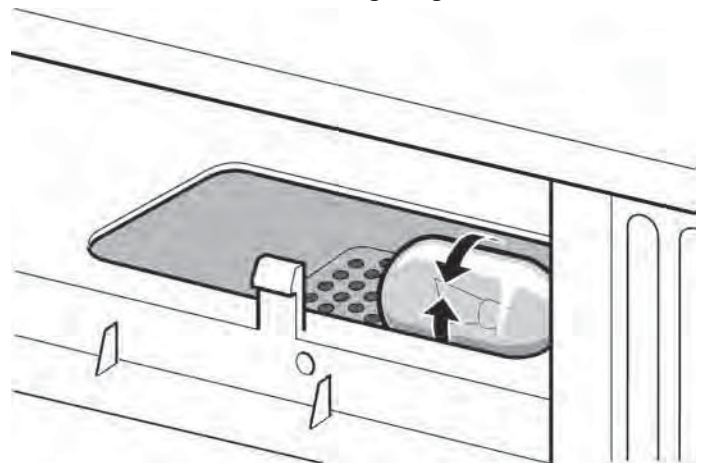

Note: DO NOT USE BULB LARGER THAN 30 WATTS.

3. Replace the microwave oven light cover by carefully pushing into place. Replace the charcoal filter. Push the vent grill back into place (engaging both the bottom and top tabs) and replace the vent grill mounting screws.

CLEANING AND CARE

**Disconnect the power cord before cleaning or
leave the door open to deactivate the oven during cleaning.**

Cleaning suggestions

For best performance and for safety reasons, keep the oven clean inside and outside. Take special care to keep the inner door panel and oven front frame free of food and grease build-up.

Never use rough scouring powder or pads on the microwave. Wipe the microwave oven inside and out with a soft cloth and a warm (not hot) mild detergent solution. Then rinse and wipe completely dry.

Wipe spatters immediately with a wet paper towel, especially after cooking greasy foods like chicken or bacon.

Clean your microwave oven weekly or more often, if needed.

Follow these instructions to clean and care for your microwave oven:

- Keep the inside (cavity) of the oven clean. Food particles and spilled liquids can stick to the oven walls, causing the oven to work less efficiently.
 - Wipe up spills immediately. Use a damp, clean cloth and mild soap. **DO NOT** use harsh detergents or abrasive cleaners.
 - To help loosen baked-on food particles or liquids, heat 2 cups of water (add the juice of 1 lemon if you desire to keep the oven fresh smelling) in a 4 cup measuring glass at High power for 5 minutes or until boiling. Let stand in oven cavity for 1 or 2 minutes.
 - Remove the glass turntable tray from the oven when cleaning the oven cavity or tray. To prevent the glass turntable from breaking, handle with care and do not put it in water immediately after cooking. Wash the turntable tray in warm sudsy water or in the dishwasher.
 - Clean the outside surface of the microwave with soap and a clean damp cloth. Dry with a clean soft cloth. To prevent damage to the operating parts of the oven, do not let water seep into any vents or openings.
 - Wash the oven door window with very mild soap and water. Be sure to use a soft clean cloth to avoid scratching.
- If steam accumulates inside or outside the oven door, wipe with a soft cloth. Steam can accumulate when operating the oven in high humidity and in no way indicates microwave leakage.
 - Never operate the oven without food in the oven cavity; this can damage the magnetron tube or glass tray. You may wish to leave a cup of water standing inside the oven when it is not in use to prevent damage if the oven is accidentally turned on.

How to Clean the Inside

Walls, Floor, Inside Window, Metal and Plastic Parts on the Door.

Some spatters can be removed with a paper towel, others may require a damp cloth. Remove greasy spatters with a sudsy cloth, then rinse with a damp cloth. Do not use abrasive cleaners or sharp utensils on oven walls.

To clean the surface of the door and the surface of the oven that come together upon closing, use only mild, non-abrasive soaps or detergents using a sponge or soft cloth. Rinse with a damp cloth and dry.

Never use a commercial oven cleaner on any part of your microwave.

Removable Turntable and Turntable Support

To prevent breakage, do not place the turntable into water just after cooking. Wash it carefully in warm, sudsy water or in the dishwasher. The turntable and support can be broken if dropped. Remember, do not operate the oven without the turntable and support in place.

How to Clean the Outside

Do not use cleaners containing ammonia or alcohol on the microwave oven. Ammonia or alcohol can damage the appearance of the microwave.

Case

Clean the outside of the microwave with a sudsy cloth. Rinse with a damp cloth and then dry. Wipe the window clean with a damp cloth.

CLEANING AND CARE

Disconnect the power cord before cleaning or leave the door open to deactivate the oven during cleaning.

Control Panel and Door

Wipe with a damp cloth. Dry thoroughly. Do not use cleaning sprays, large amounts of soap and water, abrasives or sharp objects on the panel—they can damage it. Some paper towels can also scratch the control panel.

Door Surface

It is important to keep the area clean where the door seals against the microwave. Use only mild, non-abrasive detergents applied with a clean sponge or soft cloth. Rinse well.

Power Cord

If the cord becomes soiled, unplug and wash with a damp cloth. For stubborn spots, sudsy water may be used, but be certain to rinse with a damp cloth and dry thoroughly before plugging cord into outlet.

Stainless Steel

Do not use a steel-wool pad; it will scratch the surface.

To clean stainless steel surfaces, use a hot, damp cloth with a mild detergent suitable for stainless steel surfaces. Use a clean, hot, damp cloth to remove soap. Dry with a dry, clean cloth.

If food soil remains, try a general kitchen cleaner, such as Fantastik[®], Simple Green[®] or Formula 409[®].

For hard-to-clean soil, use a standard stainless-steel cleaner, such as Bon-Ami[®] or Cameo[®].

Apply cleaner with a damp sponge. Use a clean, hot, damp cloth to remove cleaner. Dry with a dry, clean cloth. Always scrub lightly in the direction of the grain.

After cleaning, use a stainless-steel polish, such as Stainless Steel Magic[®], Revere Copper and Stainless Steel Cleaner[®] or Wenzol All Purpose Metal Polish[®]. Follow the product instructions for cleaning the stainless-steel surface.

SERVICE CALL CHECK

Please check the following before calling for service:

Place one cup of water in a glass measuring cup in the microwave oven and close the door securely.
Operate the microwave oven for one minute at HIGH 100%.

- | | | |
|---|----------|---------|
| A Does the microwave oven light come on? | YES ____ | NO ____ |
| B Does the cooling fan work? (Put your hand at top above Display.) | YES ____ | NO ____ |
| C Does the turntable rotate? (It is normal for the turntable to turn in either direction.) | YES ____ | NO ____ |
| D Is the water in the microwave oven warm? | YES ____ | NO ____ |

If “NO” is the answer to any of the above questions, please check electrical outlet, fuse and/or circuit breaker. If they are functioning properly, CONTACT YOUR NEAREST ELECTROLUX AUTHORIZED SERVICER.

A microwave oven should never be serviced by a “do-it-yourself” repair person.

NOTES

1. If time appearing in the display is counting down very rapidly, check Demonstration Mode on page 25 and cancel.
2. If the oven is set for more than 40 minutes at 80, 90 or 100 percent power level, after the first 40 minutes the power level will automatically adjust itself to 70 percent power to avoid overcooking.

SPECIFICATIONS

AC Line Voltage:	Single phase 120V, 60Hz, AC only
AC Power Required:	1500W 13.5 A (for FGMV154CLF, FGMV153CLB/W CGMV154CLF,CGMV153CLB/W)
Output Power*:	900 W
Output Power*(convection):	1450 W
Frequency:	2450 MHz (Class B/Group2)**
Outside Dimensions (including handle):	29.88 "(W) x 15.75 "(H) x 15.04 "(D)
Cavity Dimensions:	20.24 "(W) x 8.94 "(H) x 13.94 "(D)
Microwave oven Capacity***:	1.5 Cu.Ft.
Cooking Uniformity:	Turntable
Weight:	Approx. (net) 63.93 lb, (gross) 69.45 lb
Work/Night Light:	2 bulbs 30w each (incandescent light bulbs)
Oven Light:	1 bulb 30w (incandescent light bulbs)

* The International Electrotechnical Commission’s standardized method for measuring output wattage. This test method is widely recognized.

** This is the classification of ISM (Industrial, Scientific and Medical) equipment described in the International Standard CISPR11.

*** Internal capacity is calculated by measuring maximum width, depth and height. Actual capacity for holding food is less.

In compliance with standards set by:

FCC - Federal Communications Commission Authorized.

DHHS - Complies with Department of Health and Human Services (DHHS) rule, CFR, Title 21, Chapter I, Subchapter J.



- This symbol on the nameplate means the product is listed by Underwriters Laboratories, Inc.



- This symbol on the nameplate means the product is listed by Underwriters Laboratories, Inc. for use in Canada.

MAJOR APPLIANCE WARRANTY INFORMATION

Your appliance is covered by a one year limited warranty. For one year from your original date of purchase, Electrolux will pay all costs for repairing or replacing any parts of this appliance that prove to be defective in materials or workmanship when such appliance is installed, used and maintained in accordance with the provided instructions.

Exclusions This warranty does not cover the following:

1. Products with original serial numbers that have been removed, altered or cannot be readily determined.
2. Product that has been transferred from its original owner to another party or removed outside the USA or Canada.
3. Rust on the interior or exterior of the unit.
4. Products purchased "as-is" are not covered by this warranty.
5. Food loss due to any refrigerator or freezer failures.
6. Products used in a commercial setting.
7. Service calls which do not involve malfunction or defects in materials or workmanship, or for appliances not in ordinary household use or used other than in accordance with the provided instructions.
8. Service calls to correct the installation of your appliance or to instruct you how to use your appliance.
9. Expenses for making the appliance accessible for servicing, such as removal of trim, cupboards, shelves, etc., which are not a part of the appliance when it is shipped from the factory.
10. Service calls to repair or replace appliance light bulbs, air filters, water filters, other consumables, or knobs, handles, or other cosmetic parts.
11. Surcharges including, but not limited to, any after hour, weekend, or holiday service calls, tolls, ferry trip charges, or mileage expense for service calls to remote areas, including the state of Alaska.
12. Damages to the finish of appliance or home incurred during installation, including but not limited to floors, cabinets, walls, etc.
13. Damages caused by: services performed by unauthorized service companies; use of parts other than genuine Electrolux parts or parts obtained from persons other than authorized service companies; or external causes such as abuse, misuse, inadequate power supply, accidents, fires, or acts of God.

DISCLAIMER OF IMPLIED WARRANTIES; LIMITATION OF REMEDIES

CUSTOMER'S SOLE AND EXCLUSIVE REMEDY UNDER THIS LIMITED WARRANTY SHALL BE PRODUCT REPAIR OR REPLACEMENT AS PROVIDED HEREIN. CLAIMS BASED ON IMPLIED WARRANTIES, INCLUDING WARRANTIES OF MERCHANTABILITY OR FITNESS FOR A PARTICULAR PURPOSE, ARE LIMITED TO ONE YEAR OR THE SHORTEST PERIOD ALLOWED BY LAW, BUT NOT LESS THAN ONE YEAR. ELECTROLUX SHALL NOT BE LIABLE FOR CONSEQUENTIAL OR INCIDENTAL DAMAGES SUCH AS PROPERTY DAMAGE AND INCIDENTAL EXPENSES RESULTING FROM ANY BREACH OF THIS WRITTEN LIMITED WARRANTY OR ANY IMPLIED WARRANTY. SOME STATES AND PROVINCES DO NOT ALLOW THE EXCLUSION OR LIMITATION OF INCIDENTAL OR CONSEQUENTIAL DAMAGES, OR LIMITATIONS ON THE DURATION OF IMPLIED WARRANTIES, SO THESE LIMITATIONS OR EXCLUSIONS MAY NOT APPLY TO YOU. THIS WRITTEN WARRANTY GIVES YOU SPECIFIC LEGAL RIGHTS. YOU MAY ALSO HAVE OTHER RIGHTS THAT VARY FROM STATE TO STATE.

If You Need Service Keep your receipt, delivery slip, or some other appropriate payment record to establish the warranty period should service be required. If service is performed, it is in your best interest to obtain and keep all receipts. Service under this warranty must be obtained by contacting Electrolux at the addresses or phone numbers below.

This warranty only applies in the USA and Canada. In the USA, your appliance is warranted by Electrolux Major Appliances North America, a division of Electrolux Home Products, Inc. In Canada, your appliance is warranted by Electrolux Canada Corp. Electrolux authorizes no person to change or add to any obligations under this warranty. Obligations for service and parts under this warranty must be performed by Electrolux or an authorized service company. Product features or specifications as described or illustrated are subject to change without notice.

USA

1.800.944.9044

Electrolux Home Products, Inc.,
10200 David Taylor Drive
Charlotte, NC 28262



Canada

1.800.265.8352

Electrolux Canada Corp.
5855 Terry Fox Way
Mississauga, Ontario, Canada
L5V 3E4

Printed in Thailand

Free Manuals Download Website

<http://myh66.com>

<http://usermanuals.us>

<http://www.somanuals.com>

<http://www.4manuals.cc>

<http://www.manual-lib.com>

<http://www.404manual.com>

<http://www.luxmanual.com>

<http://aubethermostatmanual.com>

Golf course search by state

<http://golfingnear.com>

Email search by domain

<http://emailbydomain.com>

Auto manuals search

<http://auto.somanuals.com>

TV manuals search

<http://tv.somanuals.com>