



Range Hoods

Vented

Safety Information 3

*Operating/Care and
Cleaning Instructions*

Charcoal Filters 5

Grease Filters 4

Hood Lights 5

Hood Surfaces 5

Stainless Steel Surfaces 5

Vent Controls 4

Installation Instructions . . . 6-14

Customer Service

Product Registration 2

Consumer Support . . . Back Cover

Warranty 15

**Owner's Manual
and Installation
Instructions**

JV535

JV536

JV565

JV566

JV635

JV636

JV665

JV666



GE & You, A Service Partnership.



IMPORTANT!

Fill out the Consumer Product Registration Card.

Two easy ways to register your appliance!

- Through the internet at www.geappliances.com
- Complete and mail the enclosed Product Registration Card

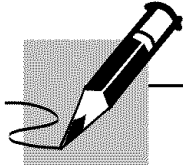

FOR YOUR RECORDS

Write the model and serial numbers here:

You can find them on a label on the back wall of the hood.

Staple sales slip or cancelled check here.

Proof of the original purchase date is needed to obtain service under the warranty.

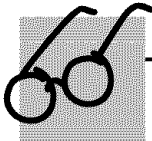

READ THIS MANUAL

Inside you will find many helpful hints on how to use and maintain your range hood properly. Just a little preventive care on your part can save you a great deal of time and money over the life of your range hood.

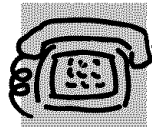

IF YOU NEED SERVICE

If you do need service, you can relax knowing help is only a phone call away. A list of toll-free customer service numbers is included in the back section of this manual.

OR

Visit our Website at: www.geappliances.com

IMPORTANT SAFETY INFORMATION. READ ALL INSTRUCTIONS BEFORE USING.



SAFETY PRECAUTIONS

WARNING — TO REDUCE THE RISK OF FIRE, ELECTRIC SHOCK OR INJURY TO PERSONS, OBSERVE THE FOLLOWING:

- A. Use this unit only in the manner intended by the manufacturer. If you have questions, contact the manufacturer.
- B. Before servicing or cleaning unit, switch power off at service panel and lock the service disconnecting means to prevent power from being switched on accidentally. When the service disconnecting means cannot be locked, securely fasten a prominent warning device, such as a tag, to the service panel.
- C. Do not use this unit with any solid-state speed control device.
- D. This unit must be grounded.

CAUTION — For general ventilating use only. Do not use to exhaust hazardous or explosive materials and vapors.

WARNING — TO REDUCE THE RISK OF INJURY TO PERSONS IN THE EVENT OF A RANGE TOP GREASE FIRE, OBSERVE THE FOLLOWING*:

- A. SMOTHER FLAMES with a close-fitting lid, cookie sheet, or metal tray, then turn off the burner. BE CAREFUL TO PREVENT BURNS. If the flames do not go out immediately, EVACUATE AND CALL THE FIRE DEPARTMENT.
- B. NEVER PICK UP A FLAMING PAN— You may be burned.
- C. DO NOT USE WATER, including wet dishcloths or towels—a violent steam explosion will result.
- D. Use an extinguisher ONLY if:
 - 1. You know you have a Class ABC extinguisher, and you already know how to operate it.
 - 2. The fire is small and contained in the area where it started.
 - 3. The fire department is being called.
 - 4. You can fight the fire with your back to an exit.

* Based on “Kitchen Firesafety Tips” published by NFPA.

WARNING — TO REDUCE THE RISK OF A RANGE TOP GREASE FIRE:

- A. Never leave surface units unattended at high settings. Boilovers cause smoking and greasy spillovers that may ignite. Heat oils slowly on low or medium settings.
- B. Always turn hood **ON** when cooking at high heat or when cooking flaming foods.
- C. Clean ventilating fans frequently. Grease should not be allowed to accumulate on fan or filter.
- D. Use proper pan size. Always use cookware appropriate for the size of the surface element.

WARNING — TO REDUCE THE RISK OF FIRE, ELECTRIC SHOCK OR INJURY TO PERSONS, OBSERVE THE FOLLOWING:

- A. Installation work and electrical wiring must be done by qualified person(s) in accordance with all applicable codes and standards, including fire-rated construction.
- B. Sufficient air is needed for proper combustion and exhausting of gases through the flue (chimney) of fuel burning equipment to prevent back drafting. Follow the heating equipment manufacturer’s guideline and safety standards such as those published by the National Fire Protection Association (NFPA), and the American Society for Heating, Refrigeration and Air Conditioning Engineers (ASHRAE), and the local code authorities.
- C. When cutting or drilling into wall or ceiling, do not damage electrical wiring and other hidden utilities.
- D. Ducted fans must always be vented to the outdoors.

WARNING — TO REDUCE THE RISK OF FIRE, USE ONLY METAL DUCTWORK.

- Do not attempt to repair or replace any part of your hood unless it is specifically recommended in this guide. All other servicing should be referred to a qualified technician.



READ AND FOLLOW THIS SAFETY INFORMATION CAREFULLY.

READ AND SAVE THESE INSTRUCTIONS

Using the hood controls.

Throughout this manual, features and appearance may vary from your model.

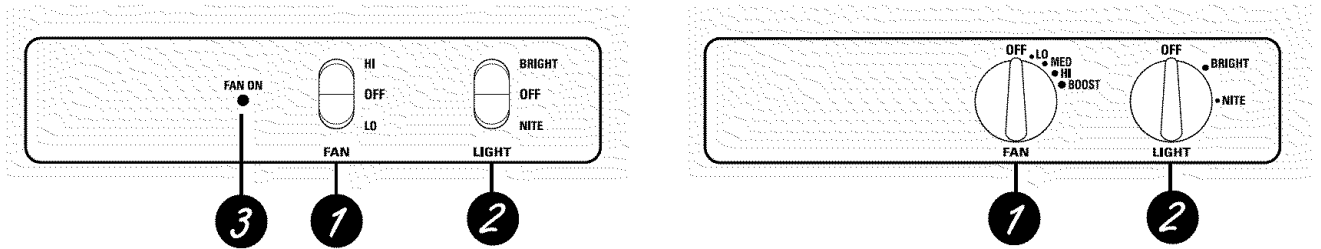

Your model will have one of the above type of controls.

1 FAN Control

Turn or press (according to your model) the **FAN** speed control to **LO**, **MED**, **HI** or **BOOST**, as needed.

Continuous use of the fan system while cooking helps keep the kitchen comfortable and less humid. It also reduces cooking odors and soiling moisture that create a frequent need for cleaning.

2 LIGHT Control

Turn or press (according to your model) the **LIGHT** control to **BRIGHT** for bright light while cooking. Turn or press to **NITE** for use as a night light.

3 FAN ON Light

The **FAN ON** indicator light will glow when the fan is turned on.

Care and cleaning of the vent hood.

Be sure electrical power is off and all surfaces are cool before cleaning or servicing any part of the vent hood.

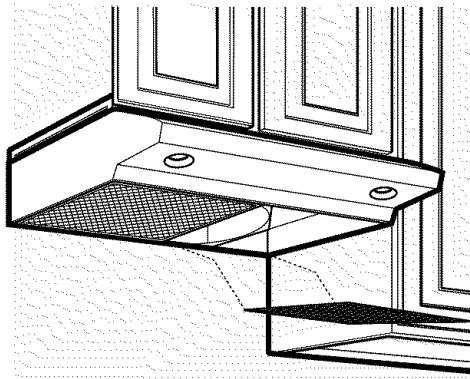

Reusable Metal Grease Filters

The hood has 2 metal reusable grease filters.

The metal filters trap grease released by foods on the cooktop. They also help prevent flaming foods on the cooktop from damaging the inside of the hood.

For this reason, the filters must **ALWAYS** be in place when the hood is used. The grease filters should be cleaned once a month, or as needed.

To remove, slide the filters to the rear using the tab. Pull them down and out.

To replace, slide the filters in the frame slot on the back of the opening. Push up and back and then to the front to lock into place.

To clean the grease filters, soak them and then swish them around in hot water and detergent. Don't use ammonia or ammonia products because they will darken the metal. Do not use abrasives or oven cleaners. Light brushing can be used to remove embedded dirt. Rinse, shake and let them dry before replacing. **They may also be cleaned in an automatic dishwasher.**

NOTE: Before cleaning, make sure the charcoal filters, if present, are unclipped and removed. See the Charcoal Filters section.

If it ever becomes necessary to replace the metal grease filters, they may be ordered from your GE supplier.

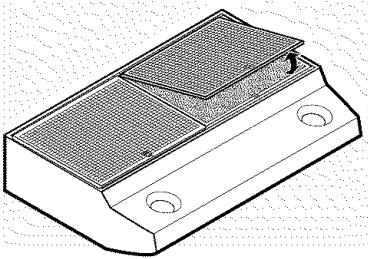

The charcoal filters are clipped inside of each reusable metal grease filter.

Charcoal Filters (on some models)

The charcoal filters cannot be cleaned. They must be replaced.

For 30" hood models, order Kit no. WB02X10707.

For 36" hood models, order Kit no. WB02X10708.

These kits can be ordered from your GE supplier.

If the model is not vented to the outside, the air will be recirculated through disposable charcoal filters that help remove smoke and odors.

The charcoal filters should be replaced when they are noticeably dirty or discolored (usually after 6 to 12 months, depending on hood usage).

NOTE: DO NOT rinse, or put charcoal filters in an automatic dishwasher.

Painted Surfaces (on some models)

To clean the hood surface, use a hot, damp cloth with a mild detergent suitable for painted surfaces. Use a clean, hot, damp cloth to remove soap. Dry with a dry, clean cloth.

Do not use steel-wool pads or other abrasive cleaners. They will scratch the surface. Wipe with a clean, hot, damp cloth after using cleansers.

Stainless Steel Surfaces (on some models)

Do not use a steel-wool pad; it will scratch the surface.

To clean the stainless steel surface, use a hot, damp cloth with a mild detergent suitable for stainless steel surfaces. Use a clean, hot, damp cloth to remove soap. Dry with a dry, clean cloth.

If food soil remains, try a general kitchen cleaner, such as Fantastik®, Simple Green®, or Formula 409®.

For hard-to-clean soil, use a standard stainless steel cleaner, such as Bon-Ami® or Cameo®.

Apply cleaner with a damp sponge. Use a clean, hot, damp cloth to remove cleaner. Dry with a dry, clean cloth. Always scrub lightly in the direction of the grain.

After cleaning, use a stainless steel polish, such as Stainless Steel Magic®, Revere Copper and Stainless Steel Cleaner®, or Weno! All Purpose Metal Polish®. Follow the product instructions for cleaning the stainless steel surface.

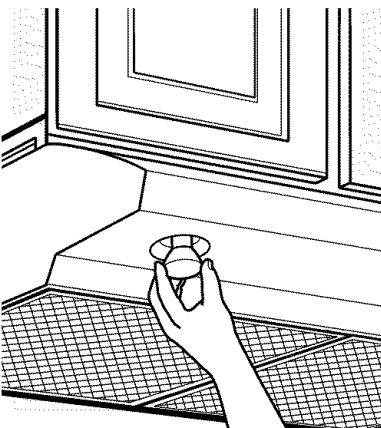

Hood Lights

This hood requires two bulbs (**not included**), maximum 50 watts.

Purchase and install PAR20, 50 W Maximum **halogen bulbs**.

When replacing a bulb, let it cool first. Make sure that power to the light has been turned off. Never allow a hot bulb to come into contact with water.

To change the light bulbs:

- 1 Grasp the bulb on the edges and unscrew it.
- 2 Replace with the same size bulb.

CAUTION:

- Do not touch the hood light bulbs when they are on. They may be hot enough to cause injury.
- The light bulbs operate at extremely high temperatures. If they shatter, the hot glass could cause personal injury.

Installation Instructions

Range Hood

Models *JV535 JV635*
JV536 JV636
JV565 JV665
JV566 JV666

Questions? Visit our Website at: www.geappliances.com or Call GE Answer Center at 800.626.2000

BEFORE YOU BEGIN

Read these instructions completely and carefully.

- **IMPORTANT** — Save these instructions for local inspector's use.
- **IMPORTANT** — Observe all governing codes and ordinances.
- **Note to Installer** — Be sure to leave these instructions with the Consumer.
- **Note to Consumer** — Keep these instructions for future reference.
- **Skill level** — Installation of this appliance requires basic mechanical and electrical skills.
- **Completion time** — 1-3 hours
- Proper installation is the responsibility of the installer.
- Product failure due to improper installation is not covered under the Warranty.
- Use only with approved cord kit, JXHCl.

FOR YOUR SAFETY:

WARNING — Before beginning the installation, switch power off at service panel and lock the service disconnecting means to prevent power from being switched on accidentally. When the service disconnecting means cannot be locked, securely fasten a prominent warning device, such as a tag, to the service panel.

DUCTWORK REQUIREMENTS

NOTE: Read the ductwork sections only if you do not have existing ductwork. If you have existing ductwork, skip to the "Damage" section and proceed.

The venting system must exhaust to the outside.

This hood can be vented vertically through upper cabinets or horizontally through an outside wall. Ductwork is not included.

Exhaust connection:

The hood exhaust has been designed to mate with standard 3¼" x 10" rectangular ducting or 7" diameter round ducting.

If a 6" round duct is required, a rectangular-to-round transition adaptor must be used*. **Do not use less than a 6" diameter duct.**

Maximum duct length:

For satisfactory air movement, the total duct length of a 3¼" x 10" rectangular, 6" or 7" diameter round duct **should not exceed 65 equivalent feet.**

NOTE: It's important that ducting be installed using the most direct route and with as few elbows as possible. This ensures clear venting of exhaust and helps prevent blockages. **Also, make sure dampers swing freely and nothing is blocking the ducts.**

Elbows, transitions, wall and roofcaps, etc., present additional resistance to airflow and are equivalent to a section of straight duct longer than their actual physical size. When calculating the total duct length, add the equivalent lengths of all transitions and adaptors plus the length of all straight duct sections. The charts on the following pages show you how to calculate total equivalent ductwork length using the approximate feet of equivalent length of some typical ducts.



* **IMPORTANT:** If a rectangular-to-round transition adaptor is used, the bottom corners of the damper will have to be cut to fit, using the tin snips, in order to allow free movement of the damper. Equivalent lengths of duct pieces are based on actual tests and reflect requirements for good venting performance with any hood.

Installation Instructions

Follow the guidelines for proper duct sizing in the ducting charts.

DUCTING CHART—JV5 Series Models

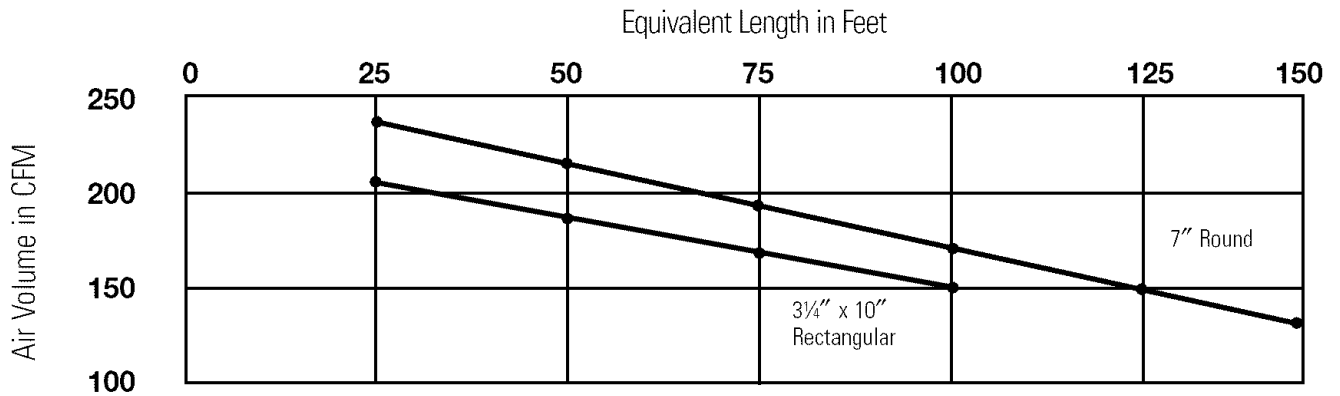

3 1/4" x 10" Rectangular Transition to 6" Round = 4.5 ft.
 7" Round 90° Elbow = 8 ft.
 7" Roof Cap = 30 ft.

DUCTING CHART—JV6 Series Models

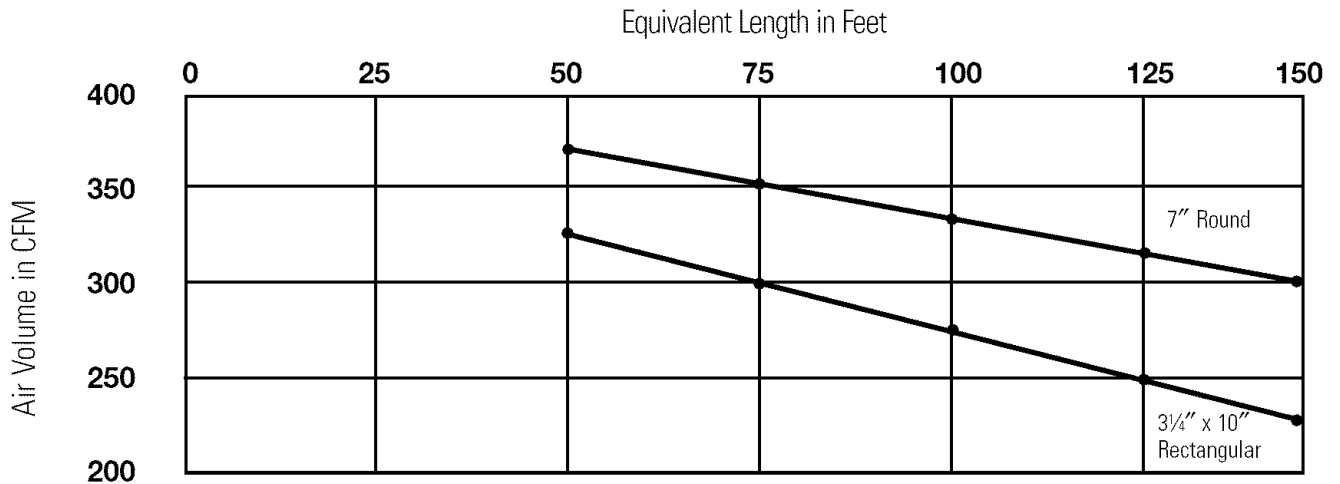



3 1/4" x 10" Rectangular Transition to 6" Round = 4.5 ft.
 7" Round 90° Elbow = 8 ft.
 7" Roof Cap = 30 ft.





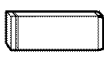
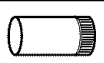
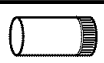
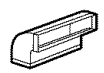
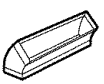
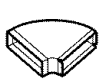
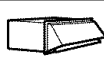
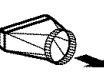
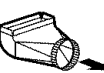

MAXIMUM DUCT LENGTH: For satisfactory air movement, the total duct length of a 3 1/4" x 10" rectangular, 6" or 7" diameter round duct **should not exceed 65 equivalent feet.**

Installation Instructions

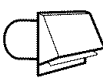
WORKSHEET—CALCULATE TOTAL EQUIVALENT DUCTWORK LENGTH

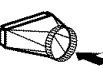
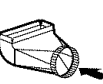
DUCT PIECES		EQUIVALENT LENGTH	x USED	=	TOTAL
	3/4" x 10" Rect., straight	1 Ft.	x ()	=	Ft.
	7" Round, straight	1 Ft.	x ()	=	Ft.
	6" Round, straight	1 Ft.	x ()	=	Ft.
	3/4" x 10" Rect. 90° elbow	8.5 Ft.	x ()	=	Ft.
	3/4" x 10" Rect. 45° elbow	7 Ft.	x ()	=	Ft.
	3/4" x 10" Rect. 90° flat elbow	24 Ft.	x ()	=	Ft.
	3/4" x 10" Rect. wall cap with damper	45 Ft. (7 ft. w/o damper)	x () x ()	=	Ft. Ft.
	3/4" x 10" Rect. to 6" round transition	4.5 Ft.	x ()	=	Ft.
	3/4" x 10" Rect. to 6" round transition 90° elbow	11.5 Ft.	x ()	=	Ft.
	6" Round, 90° elbow	8 Ft.	x ()	=	Ft.
	6" Round, 45° elbow	6.5 Ft.	x ()	=	Ft.
Subtotal column 1				=	Ft.

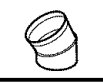
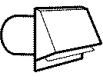
MAXIMUM DUCT LENGTH: For satisfactory air movement, the total duct length of a 3/4" x 10" rectangular, 6" or 7" diameter round duct **should not exceed 65 equivalent feet.**

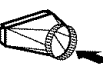
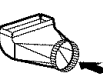
DUCT PIECES		EQUIVALENT LENGTH	x USED	=	TOTAL
	6" Round wall cap with damper	34 Ft. (6 ft. w/o damper)	x () x ()	=	Ft. Ft.
	6" Round roof cap	30 Ft.	x ()	=	Ft.
	6" Round to 3/4" x 10" rect. transition	5.5 Ft.	x ()	=	Ft.
	6" Round to 3/4" x 10" rect. transition 90° elbow	14.5 Ft.	x ()	=	Ft.
	7" Round, 90° elbow	8 Ft.	x ()	=	Ft.
	7" Round, 45° elbow	6.5 Ft.	x ()	=	Ft.
	7" Round wall cap with damper	34 Ft. (6 ft. w/o damper)	x () x ()	=	Ft. Ft.
	7" Round roof cap	30 Ft.	x ()	=	Ft.
	7" Round to 3/4" x 10" rect. transition	5.5 Ft.	x ()	=	Ft.
	7" Round to 3/4" x 10" rect. transition, 90° elbow	14.5 Ft.	x ()	=	Ft.
Subtotal column 2				=	Ft.
Subtotal column 1				=	Ft.
Total ductwork				=	Ft.

Installation Instructions

DAMAGE—SHIPMENT/INSTALLATION

- If the unit is damaged in shipment, return the unit to the store in which it was bought for repair or replacement.
- If the unit is damaged by the customer, repair or replacement is the responsibility of the customer.
- If the unit is damaged by the installer (if other than the customer), repair or replacement must be made by arrangement between customer and installer.

MOUNTING SPACE

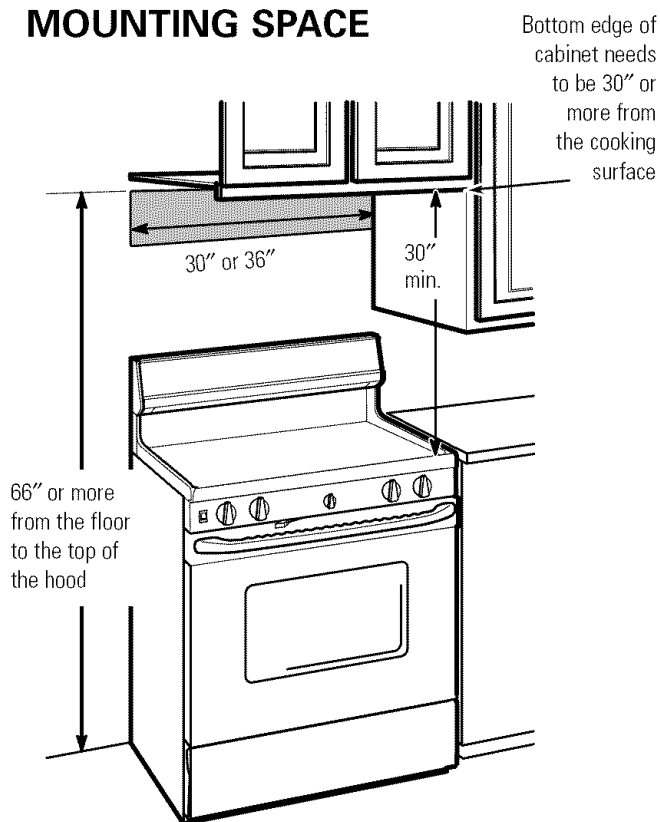





NOTES:

- This range hood is for installation over ranges up to 36" wide.
- If you are going to vent your range hood to the outside, see the "Ducting Requirements" section for exhaust duct preparation.

TOOLS YOU WILL NEED



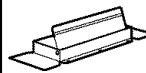

PARTS INCLUDED

PART	QUANTITY
 Metal Grease Filters	2
 Mounting Screws	4
 Exhaust Adaptor (for 3/4" x 10" rect. venting)	1
 Exhaust Adaptor Screws	2
 Exhaust Adaptor (for 7" round venting)	1

Some parts are shipped in the hood behind the filters. On some models, the bottom cover of the hood also needs to be removed to gain access to the parts.

OPTIONAL ACCESSORIES

These kits can be ordered from your GE supplier.

	Cord Kit—For both 30" and 36" models, order Kit no. JXHC1.
	Charcoal Filters—JV5 Series only, if recirculating For 30" hood models, order Kit no. WB02X10707. For 36" hood models, order Kit no. WB02X10708.

Installation Instructions

1 CHOOSE VENT OPTION

The outside vent exhaust option that your installation requires will determine the hood knockouts that you will use.

If the hood is to be installed in a recirculating, non-vented ductless manner, do not knock out any vent openings in the hood. Only an electrical access hole will be knocked out of the hood.

NOTE: Only JV5 Series models may be recirculated. We do not recommend the recirculated configuration for JV6 Series models.

Determine the vent option that your installation will require from the following choices:

A Outside top exhaust (Vertical duct—3¼" x 10" Rectangular)

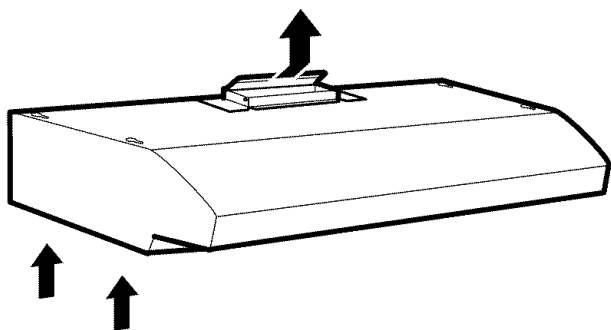

B Outside top exhaust (Vertical duct—7" Round)

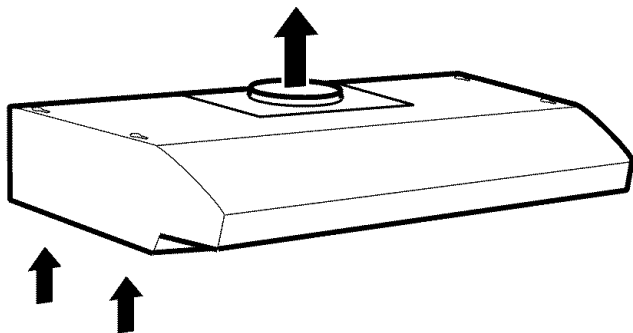

C Outside rear exhaust (Horizontal duct—3¼" x 10" Rectangular)

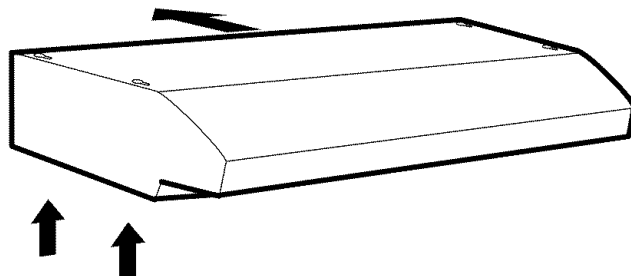

D Recirculating (Non-vented ductless—Optional for JV5 Series models only)

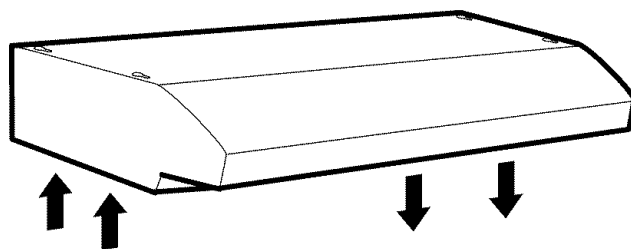

Installation Instructions

2 REMOVE EXHAUST ADAPTOR

Remove the 7" round exhaust adaptor from the top of the hood. Set it aside along with its mounting screws.

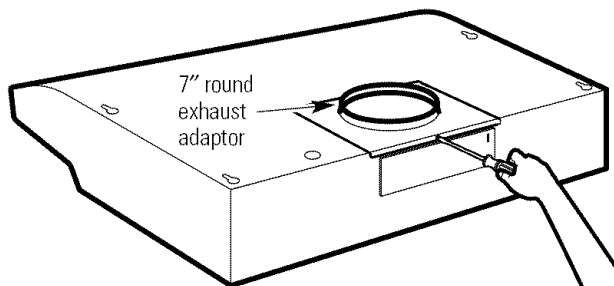

3 REMOVE FILTERS

Remove the shipping tape holding the **metal grease filters** in place. Pull down on the filter tabs and lift the filters out. Set them aside.

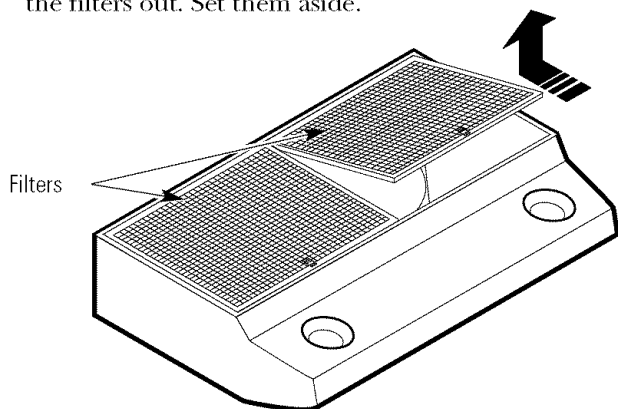

4 REMOVE BOTTOM COVER

On models so equipped, remove the **bottom cover** from the hood. Set the cover and its mounting screws aside.

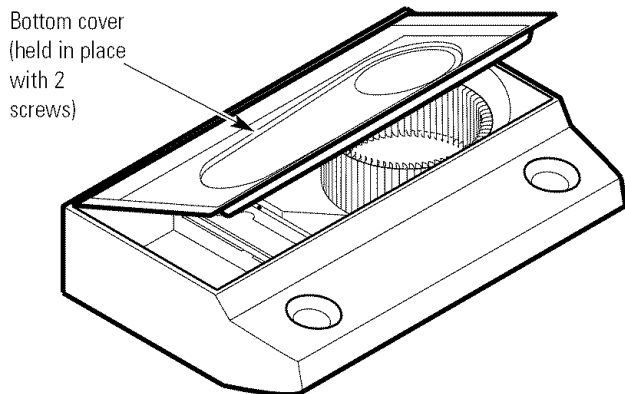

5 REMOVE OTHER EXHAUST ADAPTOR

Remove the 3/4" x 10" **rectangular exhaust adaptor** from inside the hood. Set it aside along with its mounting screws and parts bag. Depending on the model, the exhaust adaptor will be located on the left or right side.

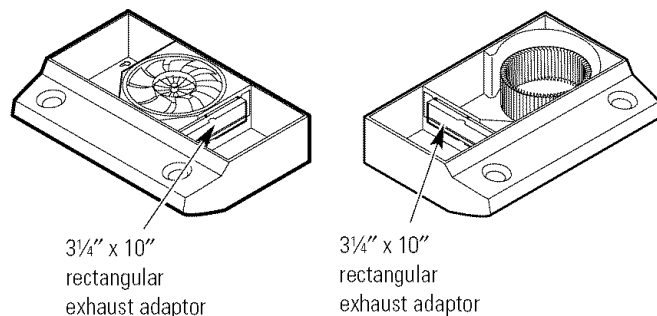

6 REMOVE WIRING COVER

On models so equipped, remove the **wiring cover** from inside the hood. Set the cover and its mounting screw aside.

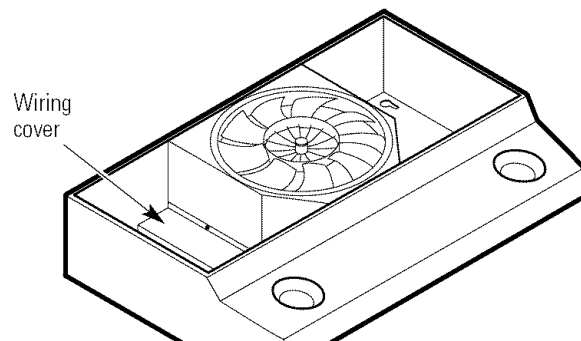

7 REMOVE WIRING KNOCKOUT

Remove either the top or the back wiring knockout as needed and install an approved **strain relief clamp**.

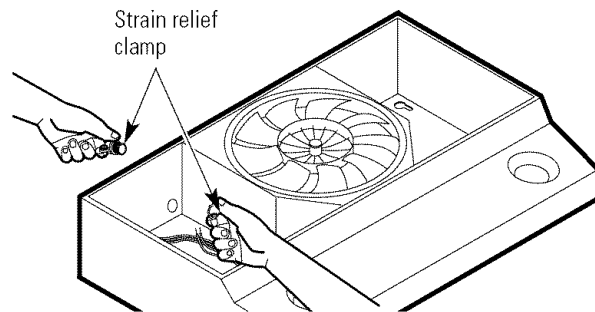

Installation Instructions

8 REMOVE DUCT KNOCKOUT(S)

If **recirculating**, non-vented ductless (optional for JV5 Series models only), see note below and **skip to Step 12 D** and proceed. We do not recommend the recirculated configuration for JV6 Series models.

Using a flat blade screwdriver, remove the appropriate duct knockout(s) from the top or back of the hood.

3/4" x 10" Rectangular vertical discharge.

Remove top rectangular duct knockout only.

7" Round vertical discharge. Remove semi-circular duct knockout and top rectangular duct knockout.

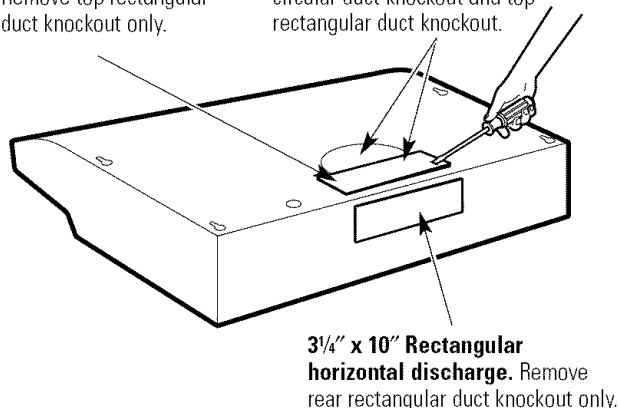

3/4" x 10" Rectangular horizontal discharge. Remove rear rectangular duct knockout only.

NOTE: If the hood is to be installed in a **recirculating**, non-vented ductless manner, order charcoal filters, kit number WB02X10707 for 30" hood models or kit number WB02X10708 for 36" hood models. These kits can be ordered from your GE supplier. **Skip to Step 12 D** and proceed.

9 FOR HORIZONTAL DISCHARGE INSTALLATIONS ONLY:

Remove the **plate** (on models so equipped) in front of the horizontal discharge knockout. Cut the **ties**, lift plate out and discard plate. **DO NOT REMOVE** the **metal strip** held in place with two **screws**.

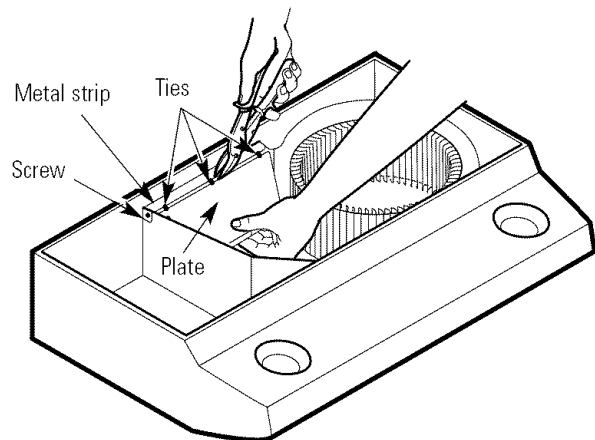

10 FOR 3/4" X 10" RECTANGULAR DUCTED DISCHARGE INSTALLATIONS ONLY:

Attach **exhaust adaptor/damper** over knockout opening with two exhaust adaptor screws. Make sure damper **pivot** is nearest to **top/back edge** of hood. Remove **tape** from damper flap.

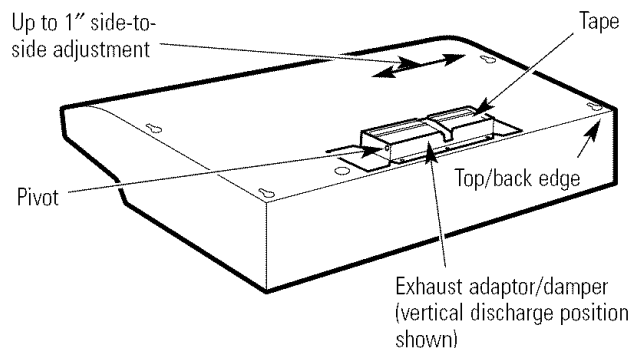

NOTE: The exhaust adaptor/damper can be installed up to 1 inch on either side of the hood center to accommodate off-center ductwork. In extreme off-center installations, one end of the duct connector may need to be trimmed to clear the electrical cable clamp.

11 FOR 7" ROUND VERTICAL DUCTED DISCHARGE INSTALLATIONS ONLY:

Re-install the **7" round exhaust adaptor** with its screws, removed in Step 2 under the "Prepare the Hood" section.

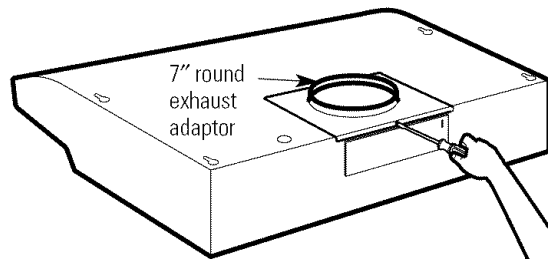

NOTE: The 7" round exhaust adaptor can be installed up to 1 inch on either side of the hood center to accommodate off-center ductwork. In extreme off-center installations, one end of the duct connector may need to be trimmed to clear the electrical cable clamp.

NOTE: The 7" round damper is not included with this product. It can be purchased as a kit by calling 800.626.2002. Order kit number JXDA23.

Installation Instructions

12 MARK HOLES

Select the vent option that your installation will require and proceed to that section:

A. Outside top exhaust (Vertical duct—3 $\frac{1}{4}$ " x 10" Rectangular)

- Use the diagram or the hood as a template and mark the locations on the cabinet for ductwork, electrical wiring and keyhole screw slots.

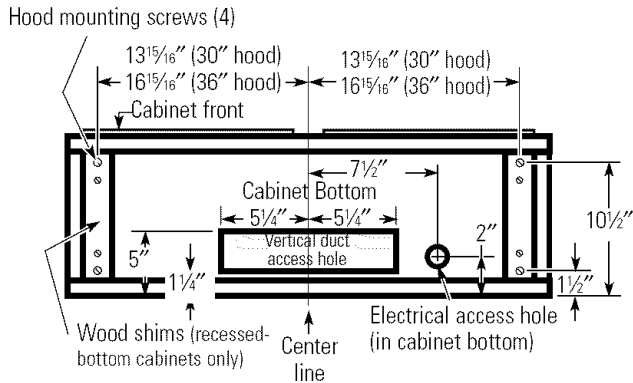

B. Outside top exhaust (Vertical duct—7" Round)

- Use the diagram or the hood as a template and mark the locations on the cabinet for ductwork, electrical wiring and keyhole screw slots.

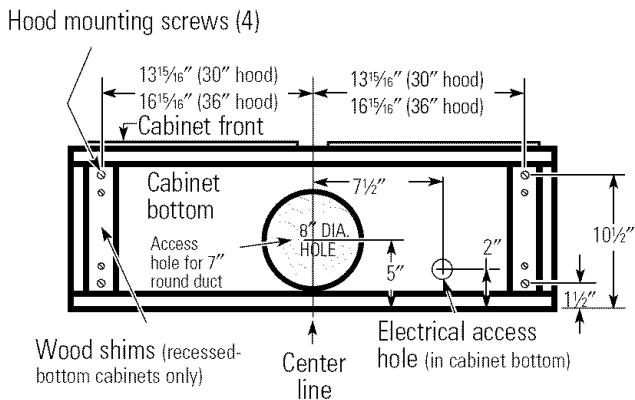

C. Outside rear exhaust (Horizontal duct—3 $\frac{1}{4}$ " x 10" Rectangular)

- Use the diagram or the hood as a template and mark the locations on the cabinet for ductwork, electrical wiring and keyhole screw slots.

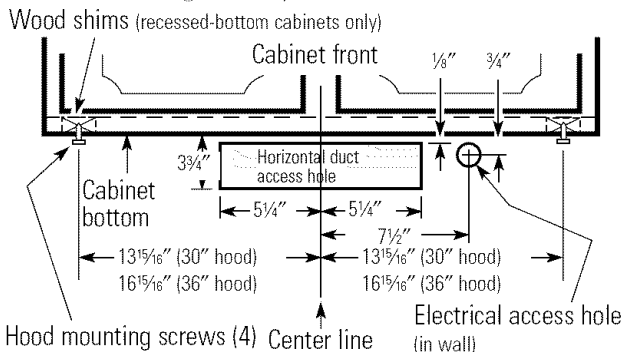

D. Recirculating (non-vented ductless— Available on JV5 Series models only)

- Use the hood as a template and mark the locations on the cabinet for the electrical wiring and keyhole screw slots.
- Since the hood is to be recirculated (not to be vented outside), do not cut out any vent openings in the wall or cabinet bottom.

13 FOR RECESSED-BOTTOM CABINETS ONLY

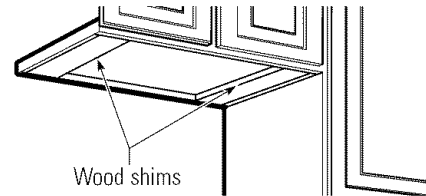

- If the cabinets have front, side or back trim, make 2 wood shims the width of the trim and attach them to the cabinet bottom recess on both sides. See Step 12 for marking locations.

14 CUT HOLES

Cut holes at marked locations for duct and electrical wiring. For the vertical duct, cut out $\frac{3}{4}$ " extra toward the front of the cabinet so you can move the duct freely when installing the hood. It may also ease installation by cutting the hole $10\frac{1}{2}$ " instead of 10".

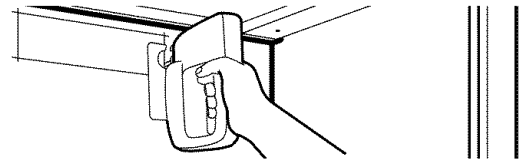

15 RUN WIRES

Run the electrical wires through the wall or cabinet according to National Electrical Code and applicable local codes.

NOTE: DO NOT turn the power on until installation is complete.

16 SCREW IN PARTWAY

Drive a mounting screw (from the hardware packet) partway into each center of the narrow neck of the keyhole slots marked on the cabinet bottom.

17 FEED IN WIRES

Lift the hood into position and feed the house wiring through the wiring knockout.

Installation Instructions

18 SECURE HOOD

Slide the hood back against the wall. Tighten the mounting screws. Be sure the screw heads are in the narrow neck of the keyhole slot.

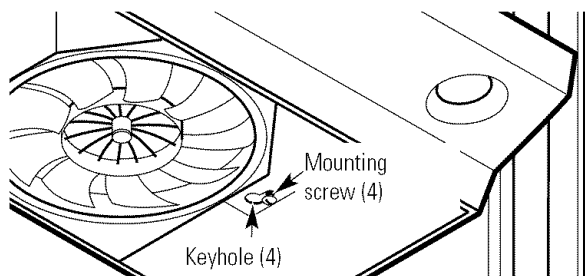

NOTE: DO NOT PUSH ON FAN BLADE. Pushing on the blade may cause it to interfere with other hood parts.

19 CONNECT DUCTWORK TO HOOD

Use duct tape to make joints secure and air tight.

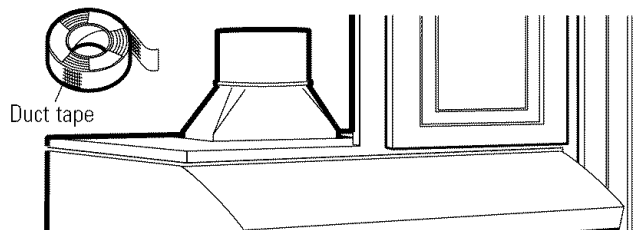

20 INSTALL LIGHT BULBS

Purchase and install two PAR20, 50 W maximum halogen bulbs.

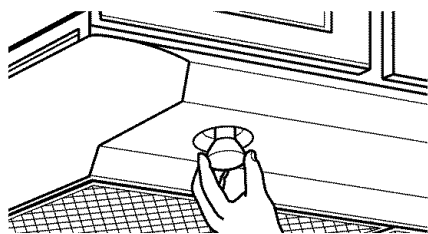

21 FOLLOW ELECTRICAL CODE

Complete the electrical wiring according to National Electrical Code and local codes.

NOTE: This hood must be permanently grounded. Connect house wiring (120 VAC) to hood wiring.

22 CONNECT WIRING

Connect house black to hood black wire, house white to hood white wire, and house ground under green ground screw. Securely tighten the strain relief clamp onto the house wiring.

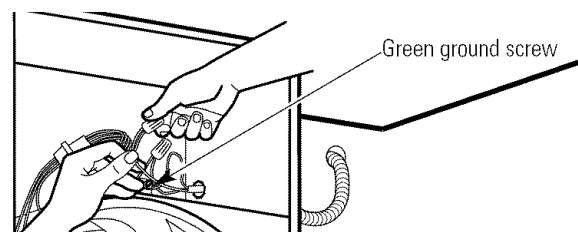

23 REPLACE WIRING COVER

On models so equipped, replace the wiring cover or the bottom cover.

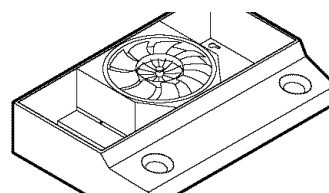

24 REPLACE FILTERS

Make sure fan blade turns freely. The installation is complete. Turn on power at service panel, and test for proper operation.

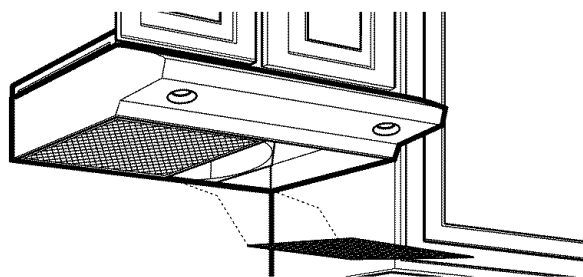

TROUBLESHOOTING CHECKLIST

If the hood seems to be operating at high speed when the control is not set on high, or if ventilation seems inadequate, check the following:

- Knockouts not removed from hood.
- Damper blade not opening.
- Reduced airflow because the duct is too small or the duct length is too long.
- The duct is blocked.
- Undersized or restrictive wall or roof cap.

GE Range Hood Warranty.

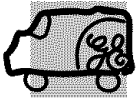

All warranty service provided by our Factory Service Centers or an authorized Customer Care® technician. For service, call 800.GE.CARES.

For The Period Of: GE Will Replace:

One Year

From the date of the original purchase

Any part of the range hood which fails due to a defect in materials or workmanship. During this **full one-year warranty**, GE will also provide, **free of charge**, all labor and in-home service to replace the defective part.

What GE Will Not Cover:

- Service trips to your home to teach you how to use the product.
- Improper installation, delivery or maintenance.
- Failure of the product if it is abused, misused, or used for other than the intended purpose or used commercially.
- Replacement of house fuses or resetting of circuit breakers.
- Damage to the product caused by accident, fire, floods or acts of God.
- Incidental or consequential damage caused by possible defects with this appliance.
- Damage caused after delivery.

This warranty is extended to the original purchaser and any succeeding owner for products purchased for home use within the USA. In Alaska, the warranty excludes the cost of shipping or service calls to your home.

Some states do not allow the exclusion or limitation of incidental or consequential damages. This warranty gives you specific legal rights, and you may also have other rights which vary from state to state. To know what your legal rights are, consult your local or state consumer affairs office or your state's Attorney General.

Warrantor: General Electric Company. Louisville, KY 40225

Safety Instructions

Operating Instructions

Installation Instructions

Customer Service

Consumer Support.



GE Appliances Website

www.GEAppliances.com

Have a question or need assistance with your appliance? Try the GE Appliances Website 24 hours a day, any day of the year! For greater convenience and faster service, you can now download Owner's Manuals, order parts, catalogs, or even schedule service on-line. You can also "Ask Our Team of Experts"[™] your questions, and so much more...

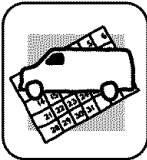

Schedule Service

www.GEAppliances.com

Expert GE repair service is only one step away from your door. Get on-line and schedule your service at your convenience 24 hours any day of the year! Or call 800.GE.CARES (800.432.2737) during normal business hours.

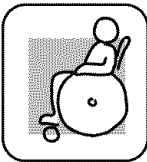

Real Life Design Studio

www.GEAppliances.com

GE supports the Universal Design concept—products, services and environments that can be used by people of all ages, sizes and capabilities. We recognize the need to design for a wide range of physical and mental abilities and impairments. For details of GE's Universal Design applications, including kitchen design ideas for people with disabilities, check out our Website today. For the hearing impaired, please call 800.TDD.GEAC (800.833.4322).



Extended Warranties

www.GEAppliances.com

Purchase a GE extended warranty and learn about special discounts that are available while your warranty is still in effect. You can purchase it on-line anytime, or call 800.626.2224 during normal business hours. GE Consumer Home Services will still be there after your warranty expires.

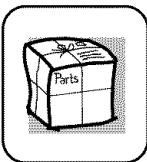

Parts and Accessories

www.GEAppliances.com

Individuals qualified to service their own appliances can have parts or accessories sent directly to their homes (VISA, MasterCard and Discover cards are accepted). Order on-line today, 24 hours every day or by phone at 800.626.2002 during normal business hours.

Instructions contained in this manual cover procedures to be performed by any user. Other servicing generally should be referred to qualified service personnel. Caution must be exercised, since improper servicing may cause unsafe operation.

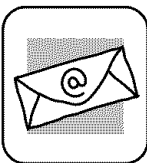

Contact Us

www.GEAppliances.com

If you are not satisfied with the service you receive from GE, contact us on our Website with all the details including your phone number, or write to: General Manager, Customer Relations
GE Appliances, Appliance Park
Louisville, KY 40225



Register Your Appliance

www.GEAppliances.com

Register your new appliance on-line—at your convenience! Timely product registration will allow for enhanced communication and prompt service under the terms of your warranty, should the need arise. You may also mail in the pre-printed registration card included in the packing material.

Free Manuals Download Website

<http://myh66.com>

<http://usermanuals.us>

<http://www.somanuals.com>

<http://www.4manuals.cc>

<http://www.manual-lib.com>

<http://www.404manual.com>

<http://www.luxmanual.com>

<http://aubethermostatmanual.com>

Golf course search by state

<http://golfingnear.com>

Email search by domain

<http://emailbydomain.com>

Auto manuals search

<http://auto.somanuals.com>

TV manuals search

<http://tv.somanuals.com>