

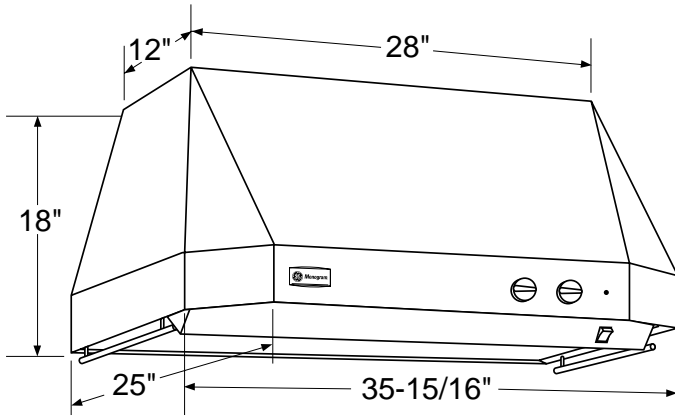

Monogram®

ZV36TSFSS – GE Monogram 36" Stainless Steel Professional Hood

Dimensions and Specifications (in inches)



Installation Clearances

These vent hoods are designed to be installed onto a wall or beneath a soffit or cabinet.

- Install these hoods* 30" min. to 36" max. above the cooking surface.

*These hoods may be installed 24" min. above a gas or electric drop-in style cooktop. Always observe the 30" to 36" clearance when installed over any professional style cooktop or range.

Note: Clearances may vary due to type of cooking product and local codes. Check with local inspectors to be sure standard is applicable.

Soffit Installation

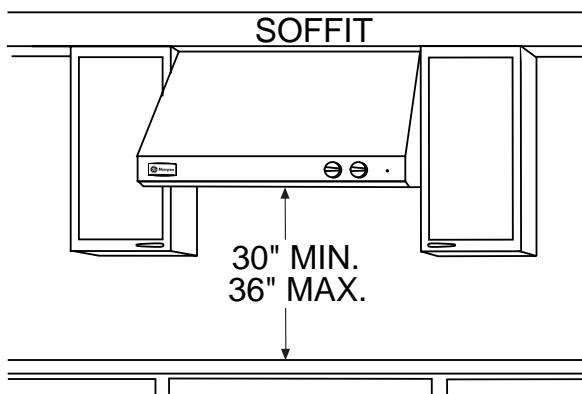

In this installation the ductwork running from the top of the hood will be concealed in the soffit or upper cabinetry.

Wall Mount Installation

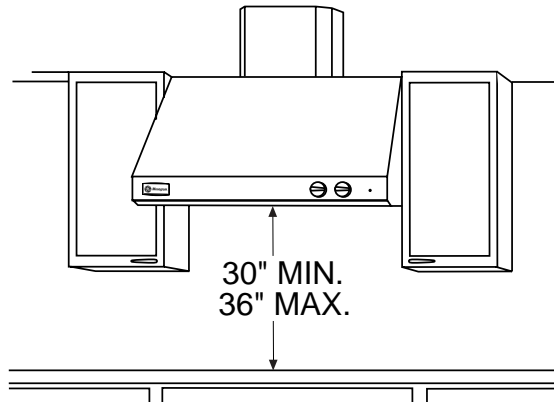

For this installation, a decorative duct cover is available to conceal the ductwork running from the top of the hood. Use of the duct cover requires special consideration to the installation height above the countertop.

Specification Revised 3/03



Listed by
Underwriters
Laboratories

For answers to your Monogram®, GE Profile™ or GE appliance questions, visit our website at GEAppliances.com or call GE Answer Center® service, 800.626.2000.



Monogram®

ZV36TSFSS – GE Monogram 36" Stainless Steel Professional Hood

Advanced Planning

Ductwork Planning

- These vent hoods are equipped for 10" round ductwork. In most instances they may be transitioned to 8" round.
- This hood may be vented vertically through upper cabinets, soffit or ceiling. A duct transition piece is supplied for vertical exhaust. Use locally supplied elbows to vent horizontally through the rear wall.
- Determine the exact location of the vent hood.
- Plan the route for venting exhaust to the outdoors.
- Use the shortest and straightest duct route possible. For satisfactory performance, duct run should not exceed 150 ft. equivalent length for any duct configurations.
- Refer to "Duct Fittings" chart to compute the maximum permissible length for duct runs to the outdoors.
- Use metal ductwork only.
- Install a wall cap or roof cap with damper at the exterior opening. Order the wall or roof cap and any transition needed in advance.

Wall Framing for Adequate Support

- These vent hoods are heavy. Adequate structural support must be provided. Hoods must be secured to vertical studs in the wall.
- It is strongly recommended that the vent hood with duct cover be on site before final framing and wall finishing. This will also help to accurately locate the ductwork and electrical service.

Decorative Duct Covers:

Decorative duct covers, 6" and 12" high, are available to fit all models. The duct cover conceals the ductwork running from the top of the hood to the ceiling or soffit. Stack one or more duct covers over the top of the hood to reach your ceiling height.

Optional Duct Cover Accessories

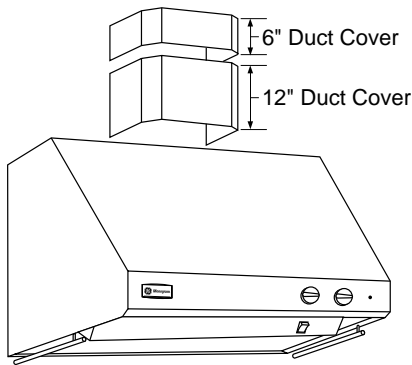

Decorative duct covers are available in 6" and 12" heights. Duct covers may be stacked, in various combinations, to conceal the ductwork running from the top of the hood to the ceiling.

- Before you begin, you should determine the installation height of the hood and order the correct size duct cover. The duct covers should be ordered at the same time as the vent hood and be on site before installation. Order the duct cover corresponding to your model.

Specification Revised 3/03

POWER SUPPLY

IMPORTANT – (Please read carefully)

WARNING: FOR PERSONAL SAFETY, THIS APPLIANCE MUST BE PROPERLY GROUNDED.

Remove house fuse or open circuit breaker before beginning installation.

Do not use an extension cord or adapter plug with this appliance. Follow national electrical codes or prevailing local codes and ordinances.

Electric supply

These vent hoods must be supplied with 120V, 60Hz, and connected to an individual, properly grounded branch circuit, and protected by a 15 or 20 amp circuit breaker or time delay fuse.

- Wiring must be 2 wire with ground.
- If the electrical supply does not meet the above requirements, call a licensed electrician before proceeding.
- Route house wiring as close to the installation location as possible on the back wall or ceiling.
- Connect the wiring to the house wiring in accordance with local codes.

Grounding instructions

The grounding conductor must be connected to a ground metal, permanent wiring system, or an equipment-grounded terminal or lead on the hood.

WARNING: The improper connection of the equipment-grounding conductor can result in a risk of electric shock. Check with a qualified electrician or service representative if you are in doubt whether the appliance is properly grounded.

6" Duct Covers

Hood Model	6" Duct Cover	Dimensions
ZV48T, ZV48S	ZX48DC6	6"H x 19-11/16"W x 11-7/8"D
ZV36T, ZV36S	ZX36DC6	6"H x 15-3/4"W x 11-7/8"D
ZV30T, ZV30S	ZX36DC6	6"H x 15-3/4"W x 11-7/8"D

12" Duct Covers

Hood Model	12" Duct Cover	Dimensions
ZV48T, ZV48S	ZX48DC12	12"H x 19-11/16"W x 11-7/8"D
ZV36T, ZV36S	ZX36DC12	12"H x 15-3/4"W x 11-7/8"D
ZV30T, ZV30S	ZX36DC12	12"H x 15-3/4"W x 11-7/8"D



Listed by Underwriters Laboratories

For answers to your Monogram®, GE Profile™ or GE appliance questions, visit our website at GEAppliances.com or call GE Answer Center® service, 800.626.2000.



Monogram®

ZV36TSFSS – GE Monogram 36" Stainless Steel Professional Hood

Using Duct Cover Accessories

To avoid unsightly gaps, plan the hood installation height for duct covers use. Use the following formula to calculate the need for one or more duct covers and to ensure a trouble free installation.

We recommend that the vent hood and decorative duct cover (if used) be on site before final framing and wall finishing. This will help to accurately locate studs, ductwork and electrical service.

- Read these examples carefully to determine the need for one or more 6" or 12" duct covers.

A = Countertop to ceiling height.

B = Gap at the top of the hood to the ceiling.

C = Hood installation height – Plus 18" hood height.

NOTE: Dia. C should be between 48" and 54" (for a 30" to 36" installation height). Raise or lower the hood installation height to allow use of one or more 6" and 12" duct covers.

Ceiling Height

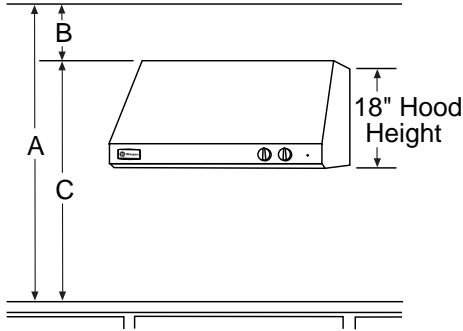

$$A - B = C$$

INSTALLATION EXAMPLES

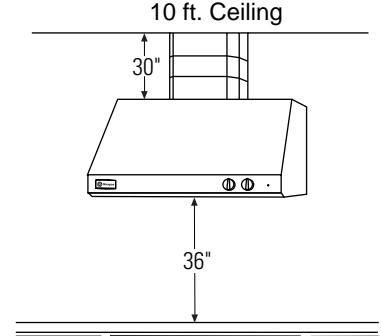
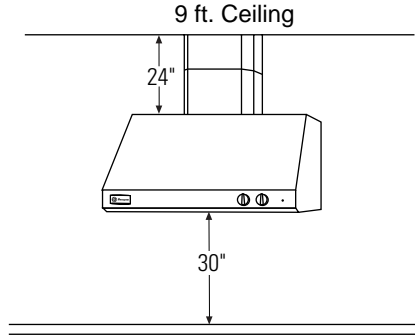
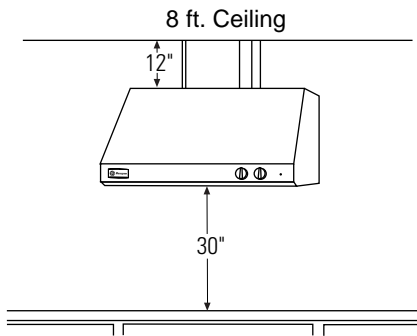

8 ft. ceilings: When the hood is installed 30" above the cooking surface and there is no soffit or upper cabinetry, order one 12" duct cover accessory.

9 ft. ceilings: When the hood is installed 30" above the cooking surface, order two 12" duct cover accessories.

10 ft. ceilings: When the hood is installed 36" above the cooking surface, order three 12" and one 6" duct cover accessories.

Specification Revised 3/03



Listed by
Underwriters
Laboratories

For answers to your Monogram®, GE Profile™ or GE appliance questions, visit our website at GEAppliances.com or call GE Answer Center® service, 800.626.2000.



Monogram.

ZV36TSFSS – GE Monogram 36" Stainless Steel Professional Hood

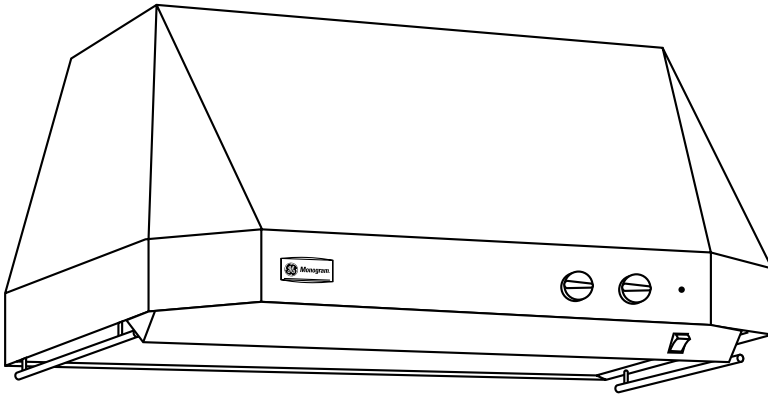

Features and Benefits

- 640 CFM Vertical Exhaust
- Variable Speed Fan Control
- 2 Halogen Lamps with 4 Lighting Levels
- Infrared Warming Lamp
- Utensil Rod
- Removable Grease Trays
- Removable Baffle Stainless Steel Filters
- Model ZV36TSFSS – Stainless steel

Free Manuals Download Website

<http://myh66.com>

<http://usermanuals.us>

<http://www.somanuals.com>

<http://www.4manuals.cc>

<http://www.manual-lib.com>

<http://www.404manual.com>

<http://www.luxmanual.com>

<http://aubethermostatmanual.com>

Golf course search by state

<http://golfingnear.com>

Email search by domain

<http://emailbydomain.com>

Auto manuals search

<http://auto.somanuals.com>

TV manuals search

<http://tv.somanuals.com>