

The Entertainer™ Activity Center

by GRACO®

OWNER'S MANUAL

Model No. _____
Serial No. _____

Dear Customer,
Please fill in the model and serial numbers above from the label under the tray of your new Entertainer™ activity center.

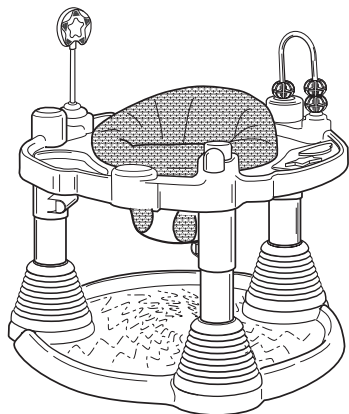

Model 4113

Congratulations on your purchase of a Graco® Entertainer™ activity center!

Graco is the recognized leader in the design and manufacture of quality baby products. We believe your new Graco® Entertainer™ activity center is a wise choice, promising many hours of enjoyment for your baby.

Before using your activity center, please take a few minutes to read this Owner's Manual. The short time you spend reading these instructions will help you to use your activity center properly.

Customer Satisfaction

Our goal is to make every product the best it can be! We are also committed to supporting our products after purchase. If you would like to speak with Graco about your product, please contact our **Customer Service Department at 1-800-345-4109**. Our knowledgeable staff will be ready to answer any questions you may have concerning parts, use or maintenance. When you call, please have the **model and serial numbers** ready so your call may be processed quickly and efficiently.

⚠ WARNING

Failure to follow these warnings and the assembly instructions could result in serious injury or death.

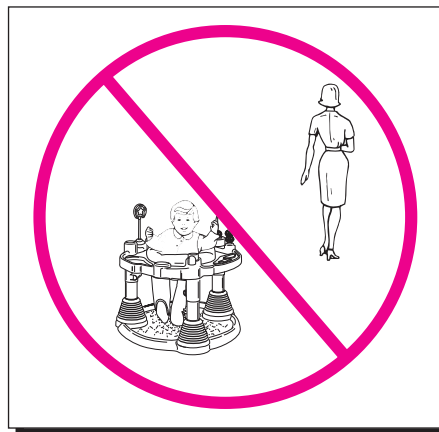

Never leave child unattended. Always keep child in view while in this product.

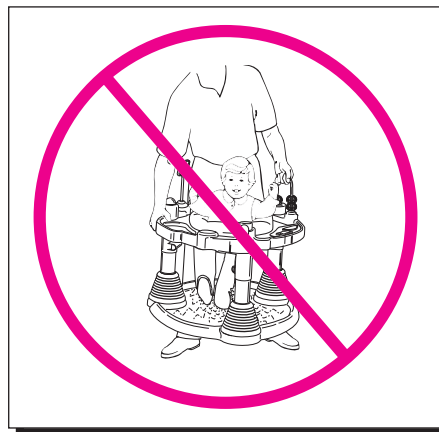

Never lift or carry this product with child in it.

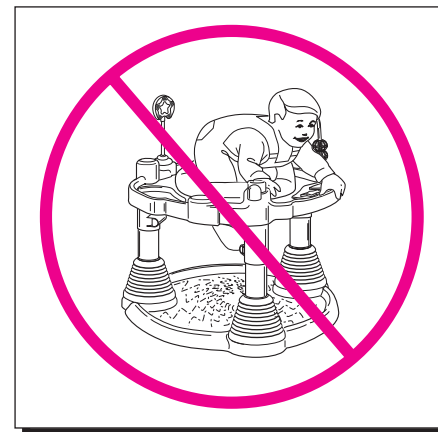

Do not use product with a child who can tip over or climb out of product.

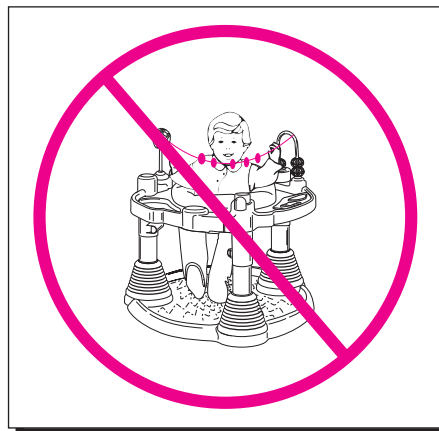

Strings can cause strangulation! DO NOT place items with a string around your child's neck, such as hood strings or pacifier cords. DO NOT suspend strings over the activity center or attach strings to toys.

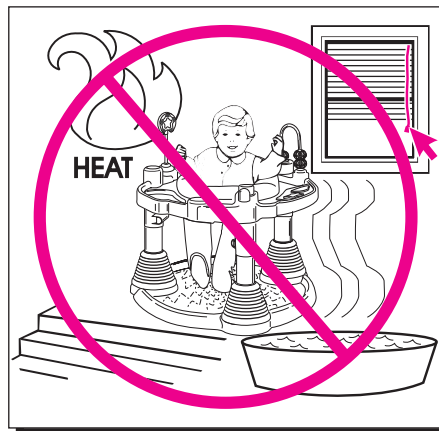

Product may gradually move across the floor as child plays in it. Watch for movement of product and be sure child stays away from hazards in the area such as stairs, cords, hot liquids, pools, sources of heat and anything else that may injure your child.



To avoid tipovers, place product on flat, level floor/ground. Adjust legs to same height so that the tray is level before placing child in product.

THIS PRODUCT REQUIRES ADULT ASSEMBLY.

READ ALL INSTRUCTIONS BEFORE ASSEMBLY AND USE OF THIS PRODUCT. If you experience any difficulties, please contact the Customer Service Department.

KEEP INSTRUCTIONS FOR FUTURE USE.

THIS PRODUCT IS FOR USE ONLY by a child who is able to sit upright unassisted, unable to walk, weighs less than 30 pounds, and is less than 32 inches tall.

EXCESSIVE EXPOSURE TO SUN OR HEAT could cause fading or warping of parts.

DO NOT USE THIS PRODUCT if it is damaged or broken.

THIS PRODUCT IS NOT INTENDED FOR COMMERCIAL USE.

PARTS LIST

CHECK that you have all the parts listed below BEFORE assembling your Entertainer™ activity center. If any parts are missing, call Customer Service at 1-800-345-4109.

Tool required: Screwdriver



Teether toy

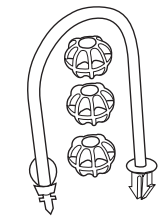

Beads and bar

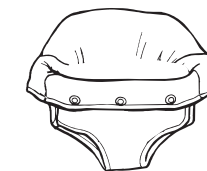

Seat

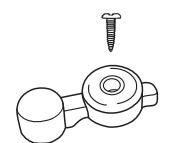

Clicker and screw

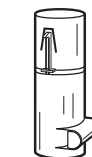

Leg (3)

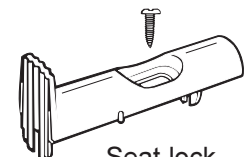

Seat lock and screw

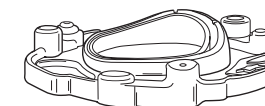

Tray and seat ring

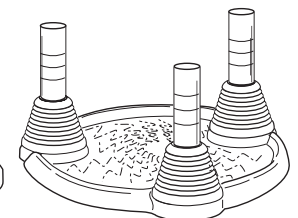

Base

CARE AND MAINTENANCE

FROM TIME TO TIME CHECK YOUR ACTIVITY CENTER for loose screws, worn parts, torn material or stitching. Replace or repair the parts as needed. Use only Graco® replacement parts.

REMOVABLE CLOTH SEAT may be machine washed in lukewarm water on delicate cycle and drip-dried. **DO NOT MACHINE DRY. NO BLEACH.**

TO CLEAN FRAME, use only household soap or detergent and warm water. **NO BLEACH.**

To Assemble Your Entertainer™ Activity Center

Step 1.

Turn the tray over and locate the hole that the seat lock screws into. Place the seat lock on the tray as shown and screw it to the tray. **DO NOT** overtighten screw—seat lock must be free to slide.

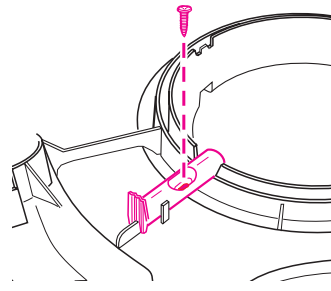

Step 2.

Four tabs are located behind the indentations inside the seat ring. Remove the seat ring by pulling the four tabs out from under the tray, one at a time, while lifting the seat ring.

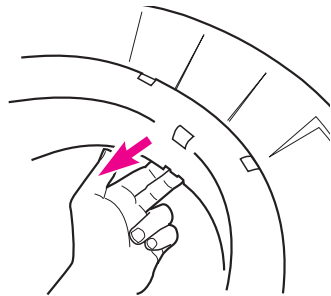

Step 3.

Put the seat ring upside down inside the cloth seat. The high side of the seat ring goes to the back of the seat, where the warning label is located.

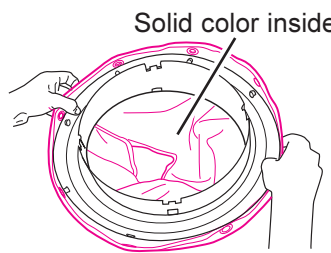

Attach the seat to the seat ring by tucking the seat edge into the channel and snapping the grommets on the pegs.

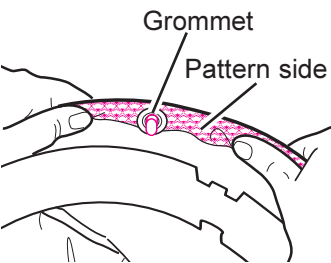

Step 4.

Turn the seat over and push the seat down into the seat ring.

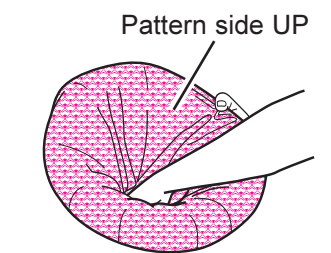

Step 5.

Snap the seat ring back onto the tray. Make sure all four tabs are snapped onto the inside lip.

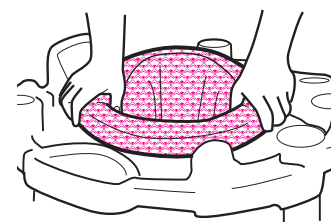

Step 6.

Turn tray over. Push one leg into socket in tray **exactly as shown** until it snaps into place. Repeat for other two legs.

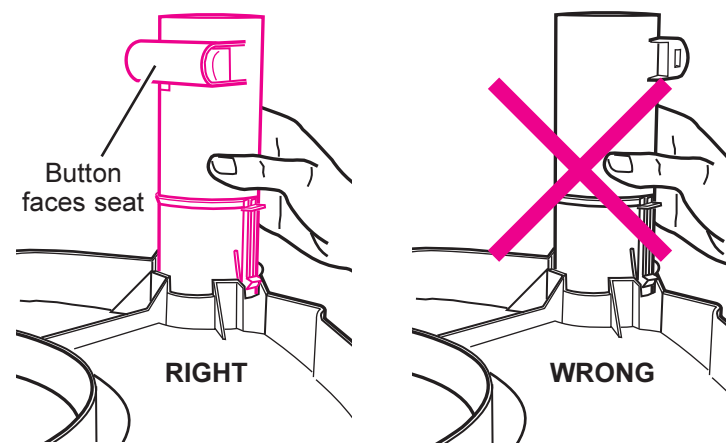

Step 7.

On top of tray, **CHECK** that snaps are visible through slots. Pull on leg to be sure it is securely attached.

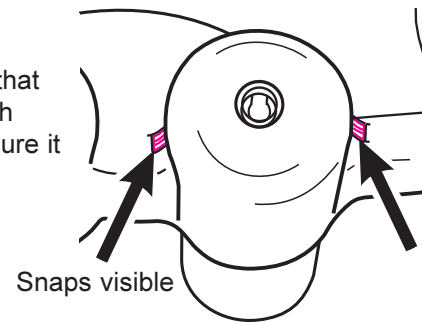

Step 8.

Slide the leg tubes on the tray onto the leg tubes on the base as shown.

HINT: If a tray leg tube will not slide onto the base leg tube, twist the base tube slightly to line up the parts.

Push in the buttons on each of the upper leg tubes and adjust the activity center to the desired height. The bottom edge of the upper tubes must be even with one of the three lines on the lower leg tube.

CHECK that all three leg tubes are set to the same height.

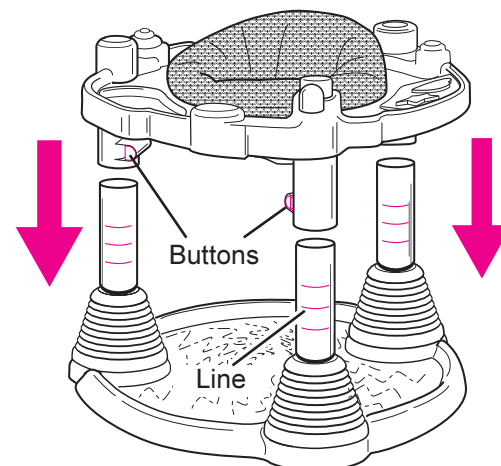

Step 9.

Assemble the toys on the tray as shown.

NOTE: Toys may be removed from tray for cleaning or storage.

Insert teether stalk into the tray.

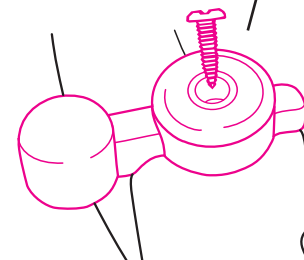
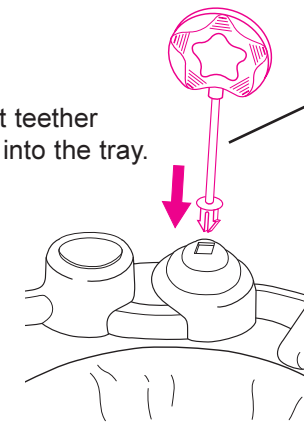

Tighten screw until clicker does not move freely—**DO NOT** overtighten—then loosen screw slightly.

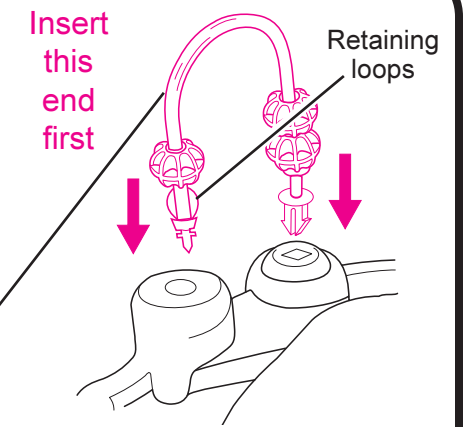

Push beads firmly over the retaining loops on bead bar. Insert end with loops into the hole directly over leg, and turn bar until fully seated (retaining loops do not go into the hole). Then plug forked end of bar into the square hole in the tray.

To Use the Seat Lock

Push gently on latch and turn the seat until latch engages in one of the four stop positions.

To allow seat to swivel again, pull lock out.

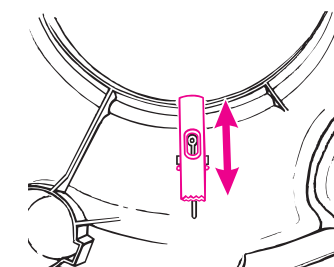

To Adjust the Seat Height

⚠ WARNING Do not adjust height while child is in activity center.

Step 1.

Press in the buttons on each leg to adjust seat to desired height. The bottom edge of the upper tubes must be even with one of the three lines on the lower leg tube.

⚠ WARNING For your child's safety, all three legs must be set to the same height. Tray must be level.

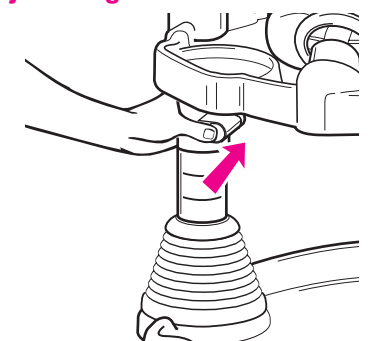

Step 2.

After adjusting height of the seat, **CHECK** that your child's feet can rest completely on the floor of your activity center. Tray should not be too high or too low. Remove child and readjust height if necessary.



Tray at proper height



TRAY TOO HIGH

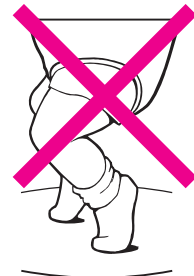

TRAY TOO LOW

Replacement Parts

Instructions for ordering activity center parts:

Complete form below. Your model number **MUST** be included on the form to ensure proper replacement parts. Your model number can be found on a sticker on the bottom of the tray. **Payment must accompany your order.**

| Parts List: | Price:* |
|--|----------------|
| Teether toy | \$ 5.00 |
| Beads and bar | \$ 5.00 |
| Clicker and screw | \$ 5.00 |
| Cloth seat | \$14.50 |
| Seat ring and bearings | \$ 7.00 |
| Seat lock and screw | \$ 5.00 |
| Complete tray unit (with legs, height springs and height buttons) | \$25.00 |
| Height buttons and height springs only | \$ 5.00 |
| Retainer rings | \$ 5.00 |
| Spring covers with upper and lower trim | \$ 5.00 |
| Complete base unit (with legs, retainer straps, boots, and retainer rings) | \$20.00 |

* Prices subject to change without notice.

IF YOU NEED HELP

If you have any questions, please call toll-free:

1-800-345-4109

Return the form below with payment to:
GRACO CHILDREN'S PRODUCTS INC.
CUSTOMER SERVICE DEPARTMENT
MAIN STREET
ELVERSON, PA 19520

| | |
|---|---|
| Model Number (Must be filled in) | SHIP TO: Name |
| <input type="checkbox"/> Teether toy | Address |
| <input type="checkbox"/> Beads and bar | City, State, Zip |
| <input type="checkbox"/> Clicker and screw | () |
| <input type="checkbox"/> Cloth seat | Telephone |
| <input type="checkbox"/> Seat ring and bearings | |
| <input type="checkbox"/> Seat lock and screw | <input type="checkbox"/> Check enclosed (payable to Graco Children's Products Inc.) |
| <input type="checkbox"/> Complete tray unit | <input type="checkbox"/> Charge to credit card: |
| <input type="checkbox"/> Height buttons and springs | <input type="checkbox"/> Visa |
| <input type="checkbox"/> Retainer rings | <input type="checkbox"/> MasterCard |
| <input type="checkbox"/> Spring covers with trim | <input type="checkbox"/> Discover |
| <input type="checkbox"/> Complete base unit | |
| Total: _____ | Account #: _____ |
| 6% sales tax (PA only): _____ | Expiration date: _____ |
| Total amount due: _____ | Signature: _____ |

Free Manuals Download Website

<http://myh66.com>

<http://usermanuals.us>

<http://www.somanuals.com>

<http://www.4manuals.cc>

<http://www.manual-lib.com>

<http://www.404manual.com>

<http://www.luxmanual.com>

<http://aubethermostatmanual.com>

Golf course search by state

<http://golfingnear.com>

Email search by domain

<http://emailbydomain.com>

Auto manuals search

<http://auto.somanuals.com>

TV manuals search

<http://tv.somanuals.com>