

# Kit Instructions

To find your local Graco/Magnum authorized service center:

- 1-888-541-9788
- Magnum.Graco.com
- Graco/Magnum Authorized Service Centers list 302367



## Pressure Roller

332981A

EN

### Model 244512, Series C / Model 16W441, Series A

3600 psi (24.8 MPa, 248 bar) Maximum Fluid Inlet Pressure\*

- 20 in. (50 cm) heavy-duty extension
- 45° swivel adapter
- 9 in. (23 cm) roller frame
- 1/2 in. (13 mm) nap roller cover

*\*Use the lowest pressure that provides an even paint supply to the roller; typically less than 300 psi (2.1 MPa, 21 bar)*



### Important Safety Instructions

Read all warnings and instructions in this manual. Save these instructions.

#### NOTICE



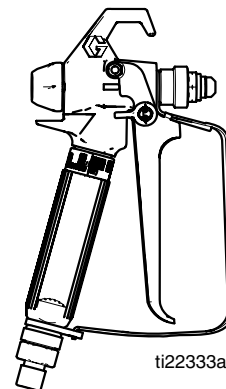
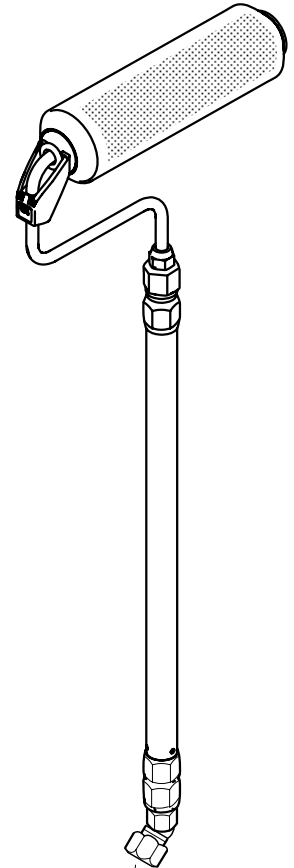



Never leave water in the pump, gun, or pressure roller. Doing so could cause corrosion and damage from freezing. For storage, flush the system with Graco Pump Armor™ or mineral spirits/paint thinner.



PROVEN QUALITY. LEADING TECHNOLOGY.

# Warnings

The following warnings are for the setup, use, grounding, maintenance, and repair of this equipment. The exclamation point symbol alerts you to a general warning and the hazard symbols refer to procedure-specific risks. When these symbols appear in the body of this manual or on warning labels, refer back to these Warnings. Product-specific hazard symbols and warnings not covered in this section may appear throughout the body of this manual where applicable.

 <b>WARNING</b>	
 	<p><b>EQUIPMENT MISUSE HAZARD</b></p> <p>Misuse can cause death or serious injury. <b>To help prevent injury:</b></p> <ul style="list-style-type: none"> <li>• Do not modify the extension tube or roller frame or use parts not designed for this equipment.</li> <li>• Do not use 1,1,1--trichloroethane, methylene chloride, other halogenated hydrocarbon solvents or fluids containing such solvents in this or any other pressurized aluminum equipment. Such use could result in a chemical reaction, with the possibility of explosion.</li> </ul>
 	<p><b>FIRE AND EXPLOSION HAZARD</b></p> <p>Improper grounding, poor ventilation, open flames or sparks can cause a hazardous condition and result in a fire or explosion and serious injury. <b>To help prevent injury from fire or explosion:</b></p> <ul style="list-style-type: none"> <li>• Provide fresh air ventilation to avoid the buildup of flammable fumes from flushing fluids or the coating being applied.</li> <li>• Keep the application area free of debris, including solvent, rags, and gasoline.</li> </ul>
	<p><b>FLUID INJECTION HAZARD</b></p> <p>If high-pressure fluid pierces your skin, the injury might look like “just a cut”. But it is a serious wound. Get immediate surgical treatment. <b>To help prevent injection:</b></p> <ul style="list-style-type: none"> <li>• Keep your hands and body away from the roller frame when flushing. High pressure fluid emitted from the holes in the frame could cause an injection injury.</li> <li>• Always relieve pressure before you check or repair leaks and when you turn off pump or stop painting.</li> <li>• Never use components rated less than system Maximum Working Pressure.</li> </ul>
	<p><b>ELECTROCUTION HAZARD</b></p> <p>Failure to observe the electrical hazards described below could result in serious injury, including burns or electrocution. To help prevent harmful electrical shock</p> <ul style="list-style-type: none"> <li>• Avoid contact with power lines.</li> <li>• Follow all grounding instructions in your separate pump and gun instruction manual, and comply with all local, state, and national fire, electrical, and safety regulations.</li> <li>• Use only MAGNUM or Graco paint hoses.</li> </ul>

## Additional Roller Covers

The following MAGNUM pressure roller covers are available at your local distributor:

243063 9 in. (23 cm) 1/2 in. (13 mm) nap

243064 9 in. (23 cm) 3/4 in. (19 mm) nap

243065 9 in. (23 cm) 1-1/4 in. (32 mm) nap

## Installation

Assemble the pressure roller as shown in the Parts Drawing on page 4. Attach pressure roller assembly to spray gun.

## Pressure Relief Procedure

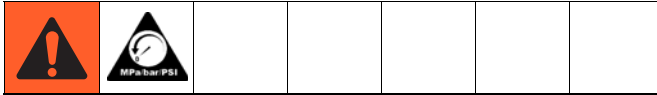

This equipment stays pressurized until pressure is manually relieved. To help prevent serious injury from pressurized fluid, such as skin injection, splashing fluid and moving parts, follow the Pressure Relief Procedure when you stop spraying and before cleaning, checking, or servicing the equipment.

1. Engage gun trigger lock.
2. Shut off power to pump.
3. Turn prime/spray valve to the PRIME position to relieve pressure in system.
4. Disengage gun trigger safety, and trigger gun to relieve any pressure in hose.
5. Engage gun trigger safety, and keep pump prime/spray valve in PRIME position until you paint again.
6. If you suspect the spray tip or hose is clogged or that pressure has not been fully relieved after following the steps above, VERY SLOWLY loosen tip guard retaining nut or hose end coupling to relieve pressure gradually, then loosen completely. Clear hose or tip obstruction.

## Operation

1. Follow pump priming instructions using lowest pressure setting at which pump primes. **NOTE:** Do not exceed minimum pressure required to supply paint to the roller.
2. Turn prime/spray valve to SPRAY position.
3. Disengage gun safety latch, trigger the gun, and roll the surface until paint comes to roller.  
**NOTE:** Trigger the gun briefly in short bursts only when you need more paint. Determine how often you must trigger the gun to maintain an even paint supply to the roller.
4. Increase pump pressure only if triggering gun cannot supply enough paint for your rolling speed.

5. Perform **Pressure Relief Procedure**.
6. Whenever you stop painting, relieve the pressure, and elevate roller end of extension tube to prevent paint from draining out.

**NOTE:** Flush the pump, gun, and pressure roller immediately after each use to prevent paint from drying in the pressure roller and damaging it. See **Cleaning** on

## Cleaning

This is the procedure for flushing the pressure roller. The pump and gun you are using may have additional flushing steps, such as cleaning filters and screens. See the pump and gun flushing instructions.

**NOTE:** Leave the pressure roller attached to the gun for this procedure.

1. Perform **Pressure Relief Procedure**.
2. Remove roller cover (19) and diffuser (23) from roller frame as follows (see Parts Drawing):
  - a. Using your thumb, press down on clip (5) to release end caps (2 & 4), diffuser (23) and roller cover (19) into a pail.
  - b. Remove roller cover (19) from diffuser (23).
  - c. Pull end caps (2 & 4) off diffuser (23). Disassemble.
3. Clean roller cover (19), caps (2 & 4) and diffuser (19) with water or a compatible fluid for oil--base materials.
4. Place roller frame (1) in paint pail. Be sure the holes in roller frame (1) are facing inside the paint pail.
5. Prime pump with water or flushing fluid for oil--based materials. Use the lowest pump priming pressure setting.
6. Turn prime/spray valve to SPRAY.  
**NOTE:** Perform Step 7 at the lowest pressure possible.
7. Trigger gun until flushing fluid begins to dilute the paint.
8. Place roller frame (1) in another bucket and continue flushing until fluid coming out of the roller frame (1) is clear.
9. Shut off the pump. Turn prime/spray valve to PRIME.

## Storage

If you are going to store the airless equipment for an extended period of time after flushing with water-base fluid, flush again with Graco Pump Armor or mineral spirits/paint thinner. Leave the fluid in the system during storage.

## Parts

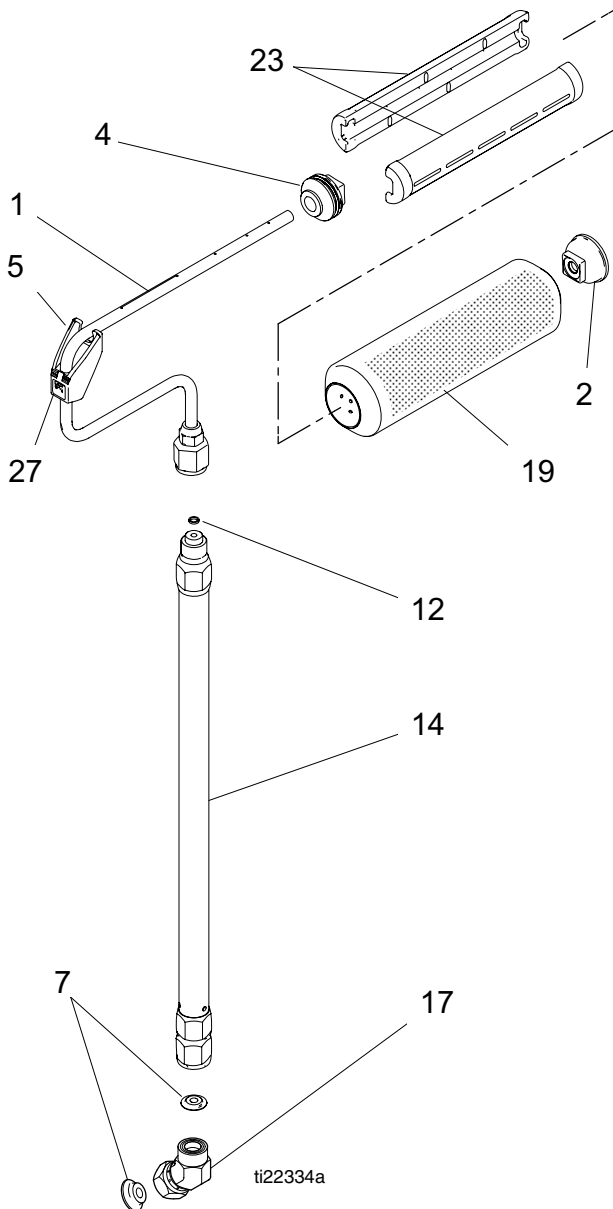

## Parts List

Ref.	Part	Description	Qty.
1		FRAME, roller	1
2	245999	CAP, end, roller	1
4	246277	CAP, end, roller	1
5	197106	CLIP, roller	1
7	15H622	GASKET, non-metallic	1
12	115524	GASKET	1
14	232122	TUBE, extension (includes 12, 7)	1
17	224399	SWIVEL, union, 45 deg, w/gasket	1
19	243063	COVER, roller, 9 in. x 1/2 in.	1
	16W445	COVER, roller, 9 in. x 1/2 in.	1
23	15B065	CORE, roller	2

All written and visual data contained in this document reflects the latest product information available at the time of publication. Graco reserves the right to make changes at any time without notice.

Original instructions. This manual contains English. MM 332981

**Graco Headquarters:** Minneapolis

**International Offices:** Belgium, China, Japan, Korea

**GRACO INC. AND SUBSIDIARIES • P.O. BOX 1441 • MINNEAPOLIS MN 55440-1441 • USA**

**Copyright 2014, Graco Inc. All Graco manufacturing locations are registered to ISO 9001.**

www.graco.com  
Revision a - 2014

## Free Manuals Download Website

<http://myh66.com>

<http://usermanuals.us>

<http://www.somanuals.com>

<http://www.4manuals.cc>

<http://www.manual-lib.com>

<http://www.404manual.com>

<http://www.luxmanual.com>

<http://aubethermostatmanual.com>

Golf course search by state

<http://golfingnear.com>

Email search by domain

<http://emailbydomain.com>

Auto manuals search

<http://auto.somanuals.com>

TV manuals search

<http://tv.somanuals.com>