

GRACO®

Stroller

OWNER'S MANUAL

Model No. _____

Serial No. _____

Dear Customer,

Please fill in the model and serial numbers above from the label on the rear leg of your new stroller.

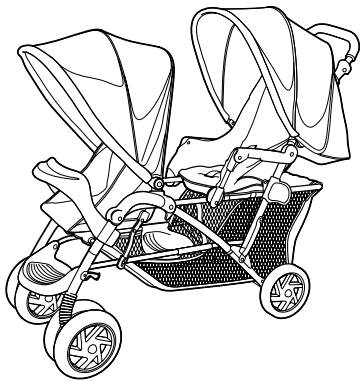

Model Nos. 7927 & 7928

Congratulations on your purchase of a Graco® stroller!

Graco is a world leader in strollers and has helped thousands of parents transport their children in comfort. We believe your new Graco® stroller is a wise choice, promising many hours of enjoyment for your baby.

Before using your stroller, please take a few minutes to read this Owner's Manual. The short time you spend reading these instructions will help you assemble and use your stroller properly.

Please save your Owner's Manual for future use.

Customer Satisfaction

Our goal is to make every product the best it can be! We are also committed to supporting our products after purchase. If you would like to speak to Graco about your product, please contact our **Customer Service Department at 1-800-345-4109** or visit our Internet website, www.gracobaby.com. Our knowledgeable staff will be ready to answer any questions you may have concerning parts, use or maintenance. When you call, please have the **model and serial numbers** ready so your call may be processed quickly and efficiently.

⚠ WARNING



Never leave child unattended. Always keep your child in view.



Avoid sliding on wet or icy surfaces.

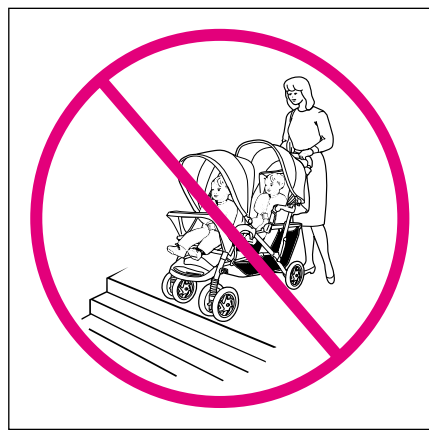

Never use stroller on stairs or escalators. You may suddenly lose control of the stroller or your child may fall out. Also, use extra care when going up or down a step or curb.

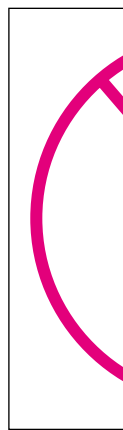

Avoid strapping items with child's neck. Do not use this product as a toy.

TO PREVENT A HAZARDOUS CONDITION, do not place more than 4.5 kg (10 lb) in the storage basket.

NEVER ALLOW YOUR STROLLER to be used as a toy.

STROLLER TO BE USED only at walking speed. Prohibited use while jogging, skating, etc.

DISCONTINUE USING YOUR STROLLER should it become damaged or broken.

Failure to follow these warnings and the assembly instructions could result in serious injury or death.

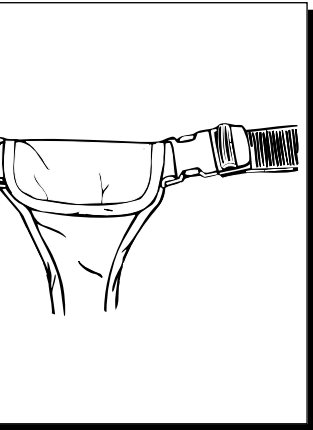

serious injury from falling or
ut. Always use seat belt.

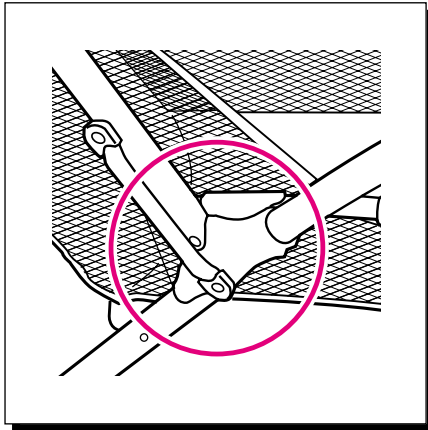

Be certain the stroller is fully erected and latched before allowing your child near the stroller.



Use of the stroller with two children weighing a total of more than 80 lbs. (36 kg) will cause excessive wear and stress on the stroller. The weight in either seat should not exceed 40 lbs. (18 kg).



ingulation. **DO NOT** place
n a string around your
ck, suspend strings from
ct, or attach strings to toys.

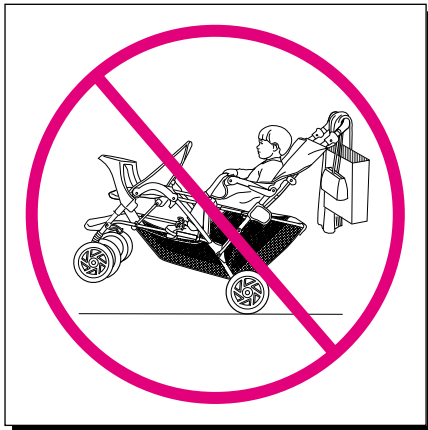

Avoid rearward tipping. Placing weight only in the rear of this stroller could cause the stroller to tip backwards.

- Always place the heaviest child or the heaviest child/carrier combination in the front seat.
- Always place the front child first. When unloading, remove the rear child first.
- Never place purses, shopping bags or accessory items on the handle or canopy.

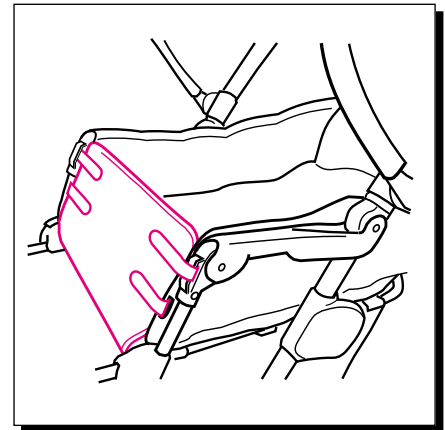

Child may slip into leg openings and strangle. Never use rear seat in a reclined carriage position unless closure flap is properly secured.

To secure the closure flap:

- Fabric side panels must be snapped at front of both armrests.
- Two lower hook/loop tabs must be threaded through buttonholes in fabric side panels and tightly fastened.
- Two upper hook/loop tabs must be threaded through plastic slots at front of armrests and tightly fastened.

place more than 10 lbs.

toy.

duct not intended for

become damaged or

FOR ADDITIONAL IMPORTANT INFORMATION, please see the Helpful Hints and Care and Maintenance sections in these instructions.

PARTS LIST

CHECK that you have all the parts listed below BEFORE assembling your stroller.

If any parts are missing, call Customer Service at 1-800-345-4109 or visit our Internet website, www.gracobaby.com.

THIS PRODUCT REQUIRES ADULT ASSEMBLY.
No tools required for assembly.

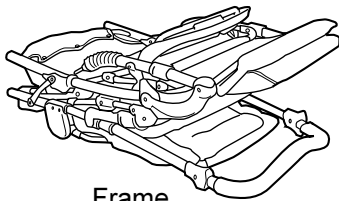

Frame

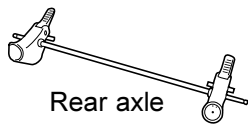

Rear axle

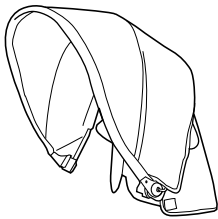

Rear canopy (with rear flap)

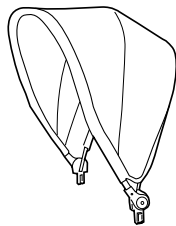

Front canopy (no flap)

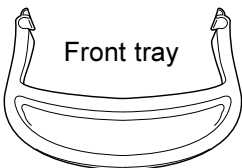

Front tray

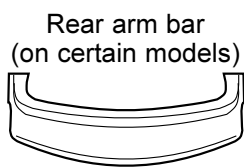

Rear arm bar (on certain models)

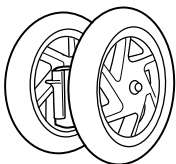

Front wheel assembly (2)



Rear wheel (2)



Retainer (2, 1 extra)



Cap (2, 1 extra)

To Unpack Stroller

Step 1.

Flatten stroller carton to protect floor.

Release storage latch on front leg. Open stroller on carton as shown until latched. Use care not to pinch fingers.

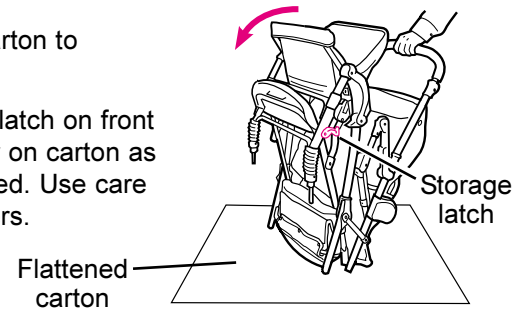

Be sure frame is latched as shown before continuing assembly.

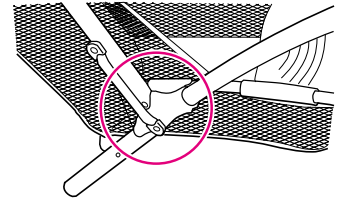

Step 2.

Push footrest down onto tube beneath it.

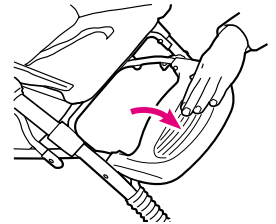

Step 3.

At rear of stroller, fasten the three basket snaps around basket frame.

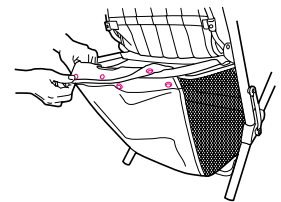

To Assemble Front Wheels

▲ WARNING To prevent serious injury or death from choking, remove and immediately discard the plastic covers on the front leg pins.

Step 1.

Line up wheel assembly with pin on front leg as shown. Plastic snaps inside wheel mount must be away from pin.

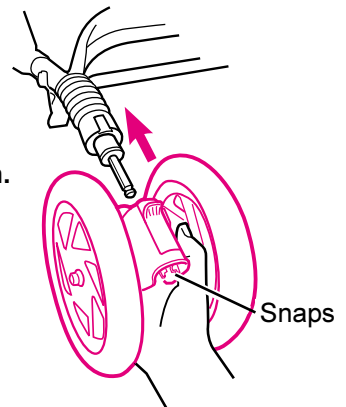

Step 2.

Push wheel assembly onto pin until it snaps in place.

Step 3.

Repeat above steps for the other side.

Pull firmly on each wheel assembly to be sure the wheel assemblies are securely attached.

To Assemble Rear Axle

Step 1.

Before assembling rear axle, it is necessary to **recline the front seat** to protect it while the stroller is inverted. To recline the front seat, push back of seat slightly forward while pulling up on wire as shown to unlock. Recline seat back.

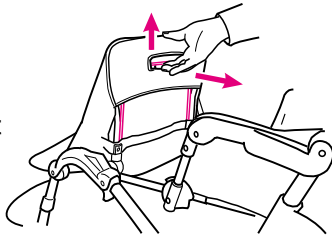

Step 2.

Turn stroller over.

Step 3.

▲WARNING To prevent serious injury or death from choking, remove and immediately discard the plastic covers on the axle.

Position rear axle assembly as shown, with brake levers pointing toward rear of stroller.

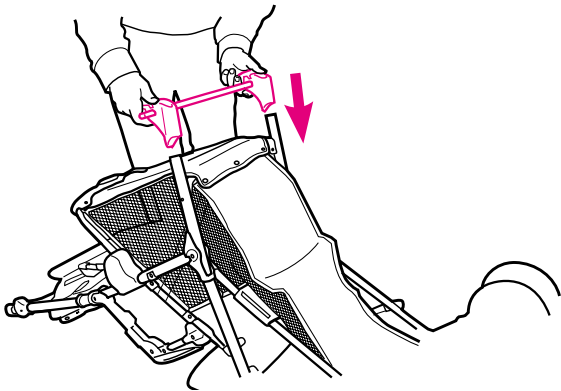

Step 4.

Push both brackets on until plastic tabs snap into the holes on the leg tubes.

Pull firmly on each bracket to be sure the brackets are securely attached.

To Assemble Rear Wheels

Place one rear wheel, red retainer and white cap on one end of rear axle **in order** as shown below. Push red retainer onto axle BEFORE attaching white cap. Repeat on other side.

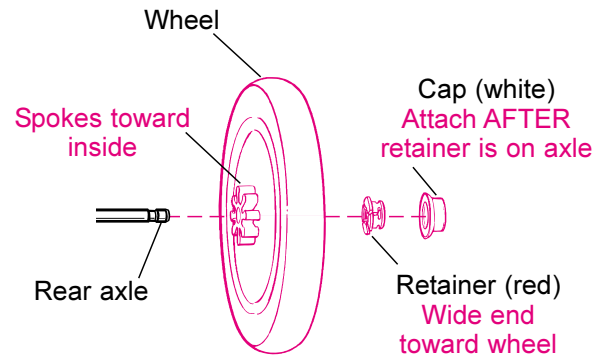

Snap red retainer into axle groove. Then snap cap over red retainer as shown.

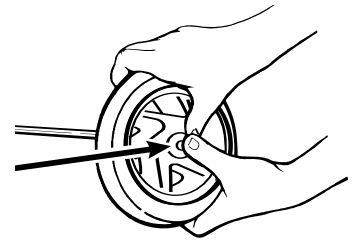

To Attach Front Tray and Rear Arm Bar (arm bar on certain models only)

▲WARNING Always secure your child with the seat belt. The tray and arm bar are not restraint devices.

DO NOT lift the stroller by the tray or arm bar.

Use care when clamping the tray or arm bar on the stroller with a child in the stroller.

Ensure plastic tray supports are positioned as low on front legs as possible. Snap the tray onto front legs of stroller as shown. Snap the arm bar onto the rear armrests. Push down on tray and arm bar to be sure they are securely clamped onto the stroller.

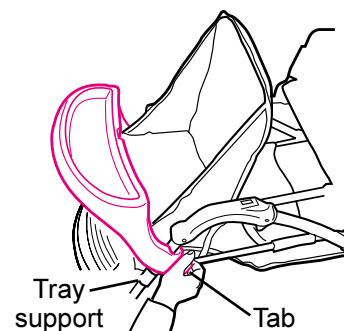

To remove, first pull tab on one side out and toward you, then unsnap the other side of the tray or arm bar.

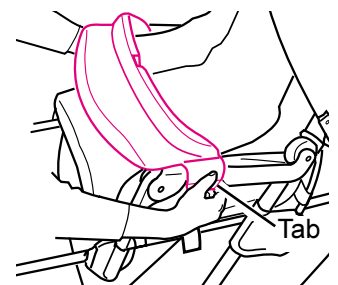

To Install Canopies

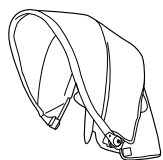

Rear canopy
(with rear flap)

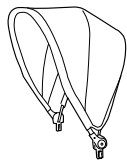

Front canopy
(no flap)

Before installing the canopies, first identify the front and rear canopies according to the pictures above. Position both canopies with the **large sewn tunnel toward the front**.

Rear Canopy:

Step 1.

Snap canopy mounts between rings on plastic sleeves above the armrests.

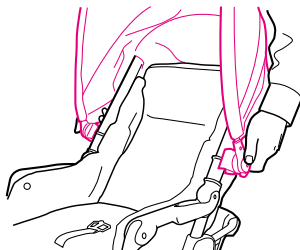

Step 2.

Fasten two hook tabs on rear canopy flap to the loop tabs on canopy. Repeat on other side.

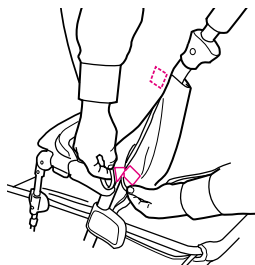

To remove canopy, reverse above steps.

Front Canopy:

Push both canopy brackets down at the same time into openings on stroller frame.

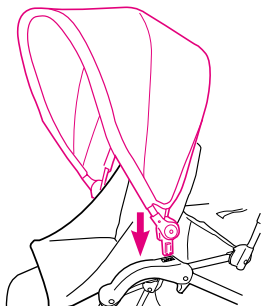

To Adjust Canopies

Push or pull either canopy to desired position.

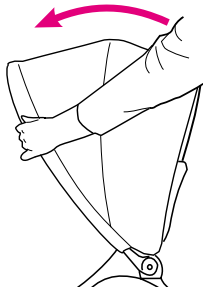

Front canopy pivots to the front or to the rear.

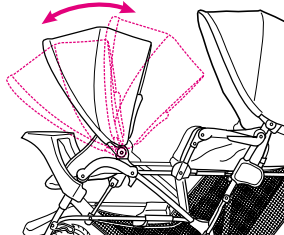

To Unfold Stroller

Step 1.

Push down on the storage latch.

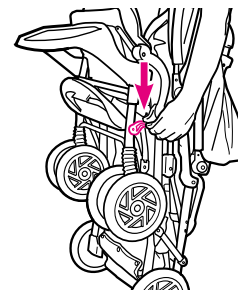

Step 2.

Unfold stroller as shown.



▲ WARNING Be certain the stroller is fully erected and latched before allowing your child near the stroller.

To Adjust Seat Backs

Front seat back has one recline position. Rear seat back has three, including fully reclined carriage position.

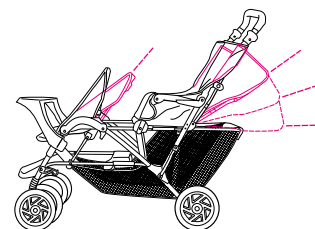

To recline either the front or rear seat back, push back of seat slightly forward while pulling up on wire as shown to unlock. Recline seat back to the desired position.

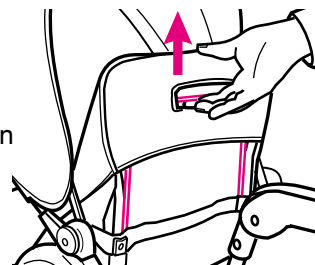

▲ WARNING Child may slip into leg openings and strangle. Never use rear seat in a reclined carriage position unless closure flap is properly secured.

- Fabric side panels must be snapped at front of both armrests.
- Two lower hook/loop tabs must be threaded through buttonholes in fabric side panels and tightly fastened.
- Two upper hook/loop tabs must be threaded through plastic slots at front of armrests and tightly fastened.

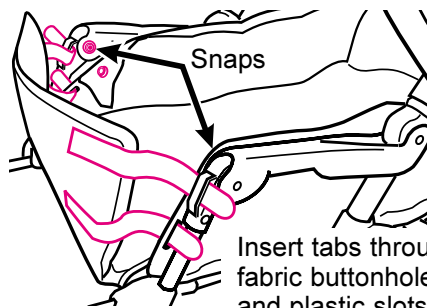

Snaps

Insert tabs through fabric buttonholes and plastic slots

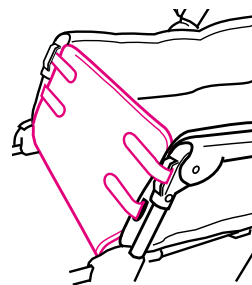

To Put Children in the Stroller

⚠ WARNING Avoid rearward tipping. Placing weight only in the rear of this stroller could cause the stroller to tip backwards.

- Always place the heaviest child or the heaviest child/carrier combination in the front seat.
- Always place the front child first. When unloading, remove the rear child first.
- Never place purses, shopping bags or accessory items on the handle or canopy.

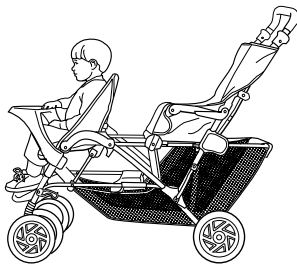

Place more weight in front seat

To Secure Your Child

⚠ WARNING Avoid serious injury from falling or sliding out. Always use seat belt.

Step 1.

Place crotch strap between legs and fasten both belt buckles together.



Step 2.

Adjust belt at both buckles as needed to get a snug fit around your child.

Step 3.

Squeeze sides of buckles to release.

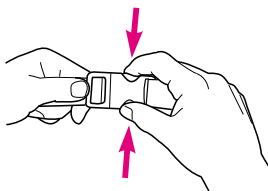

To Use Brakes

⚠ WARNING Always apply both brakes to park stroller.

Push **DOWN** to park.

Check to make sure brakes are on by trying to push the stroller.

Lift **UP** to stroll.

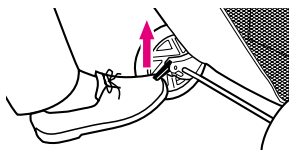
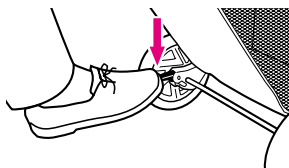

To Change to Swivel or Non-swivel Wheels

Front swivel wheels lock for use on uneven surfaces such as grass, stones or gravel.

Before locking swivels, first push stroller forward a few feet to ensure that the wheels are correctly positioned.

Push lock button **UP** to lock the swivels.

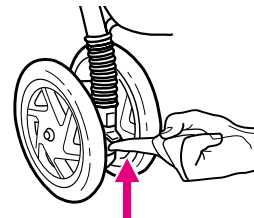

Push button **DOWN** to release.

Turn swivel to check that it is locked or released.

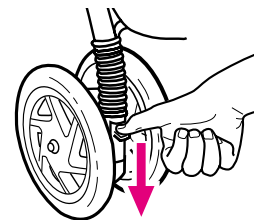

To Attach the Graco® Safety Seat (sold separately)

⚠ WARNING Improper use of this stroller with a carrier may result in serious injury or death.

Do not use this stroller with a safety seat that is not the Graco® brand.

Read the owner's manual provided with your Graco® safety seat before using the seat with this stroller.

If you do not have the owner's manual for the Graco® safety seat, call Graco at 1-888-224-6549.

Make sure the stroller is fully assembled according to the preceding instructions, with the front tray or rear armbar (on certain models) attached. Do not use a safety seat in any stroller seat that does not have a tray or arm bar installed.

Step 1.

If the stroller is folded, unfold it. Fully recline the back of the stroller seat that is to be used with a safety seat. Push down on the tray or arm bar to be sure it is securely attached to the stroller.

Step 2.

Unbuckle the stroller seat belt, move the buckles all the way to the loose end of the seat belt webbing, and hang buckles outside of the stroller.

Step 3.

If your child is already in the safety seat because you have been using it as a carrier, make sure child is secured with the harness.

▲ WARNING Always secure your child with the safety seat harness when using the safety seat in the stroller.

Step 4.

Move the safety seat handle into the carrying position.

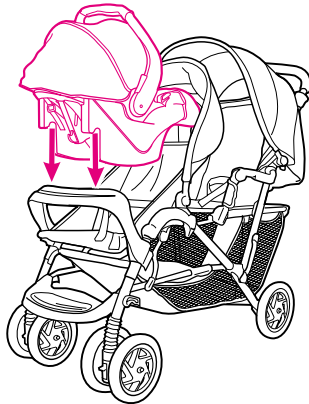

Step 5.

Position the safety seat so that the mounting notches fit over the edge of the rear arm bar or front tray. Push down on the safety seat until attachment latch snaps onto the arm bar or tray.

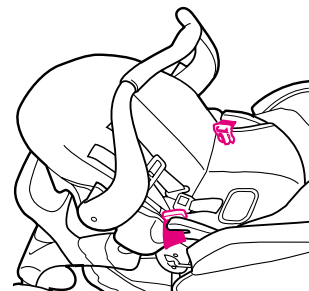

Step 6.

Slide stroller seat belt webbing under vehicle belt hooks on each side of the safety seat. Tighten stroller seat belt buckles against inside of safety seat.

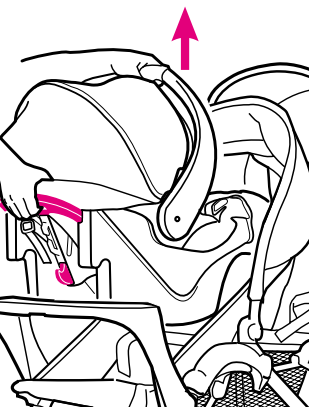

To remove safety seat from the stroller, remove stroller seat belts from vehicle belt hooks, squeeze release handle at back of safety seat, and lift safety seat out of the stroller.

To Fold Stroller

Before folding, (1) remove safety seat if in use; (2) adjust seat backs to upright position; (3) lock brakes; (4) fold canopies and lower front canopy as shown.

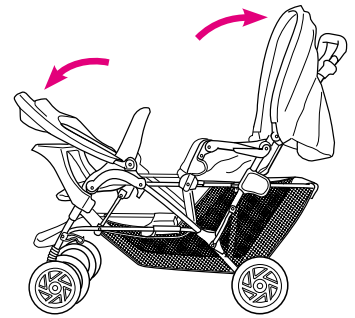

Step 1.

Pull back both fold latches at handle. Begin pushing handle forward.

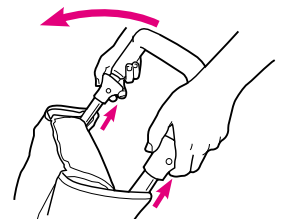

Step 2.

Hold stroller frame at base of front canopy and fold ends together until storage latch on side catches automatically.

Stroller will fold more compactly if tray and front canopy are removed and front wheels are facing backwards.

If rear wheels are locked, folded stroller will stand on its own.



To Remove Seat Pads

Front and rear seat pads can be removed if desired for cleaning or replacement.

Rear Seat Pad:

Unfasten the four snaps and three hook/loop tabs on each side, and the two snaps on back as shown. Push crotch strap and waist belt through slots in pad and remove pad.

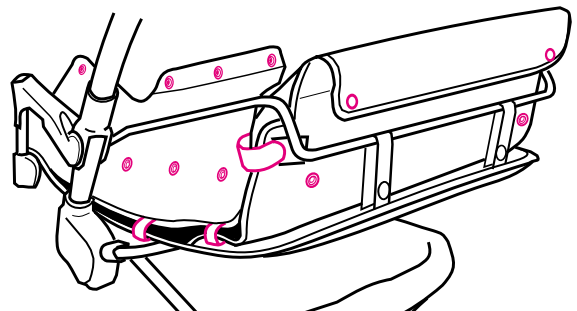

Front Seat Pad:

Unfasten the single snap at each side of seat pad. Push crotch strap and waist belt through slots in pad, and lift pad off the seat back.

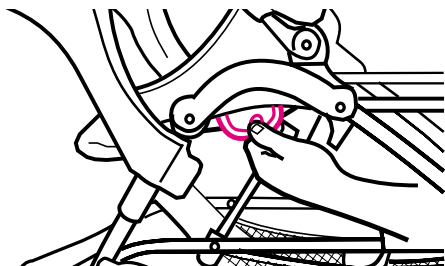

To replace pads, reverse the above steps.

Replacement Parts

Instructions for ordering stroller parts:

Complete form below. Your stroller model number **MUST** be included on the form to ensure proper replacement parts. **Your model number can be found on a sticker on the rear leg of your stroller. Payment must accompany your order.**

Parts List:	Price:**
Front seat	\$10.00
Rear seat	\$15.00
Seat pads (front or rear)	\$18.00
Front wheel assembly	\$16.00
(2 wheels per unit)	
Rear wheel	\$ 8.00 (each)
Rear axle	\$11.00
Front tray	\$12.00
Rear arm bar*	\$10.00
Basket	\$16.00
Front canopy (with frame)	\$13.00
Rear canopy (fabric only)	\$15.00
Swivel lock button	no charge

* On certain models only.

** Prices subject to change without notice.

HELPFUL HINTS

IF WHEEL SQUEAKS, use a light oil (e.g., WD-40, 3-in-1, or sewing machine oil). It is important to get the oil into the axle and wheel assembly as shown.

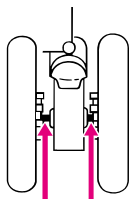

WHEN USING YOUR STROLLER AT THE BEACH, completely clean your stroller afterward to remove sand and salt from mechanisms and wheel assemblies.

CARE AND MAINTENANCE

DO NOT MACHINE WASH SEAT. It should only be wiped with a mild detergent, taking care not to soak the material. **NO BLEACH.**

REMOVABLE SEAT PAD may be machine washed in lukewarm water on delicate cycle and drip-dried. **NO BLEACH.**

TO CLEAN STROLLER FRAME, use only household soap or detergent and warm water. **NO BLEACH.**

FROM TIME TO TIME CHECK YOUR STROLLER for loose screws, worn parts, torn material or stitching. Replace or repair the parts as needed. Use only Graco® replacement parts.

EXCESSIVE EXPOSURE TO SUN OR HEAT could cause fading or warping of parts.

IF YOU NEED HELP

If you have any questions or if you need any part not listed, please call toll-free:

1-800-345-4109

or visit our Internet website, www.gracobaby.com.

Return the form below with payment to:
GRACO CHILDREN'S PRODUCTS INC.
CUSTOMER SERVICE DEPARTMENT
P.O. BOX 100, MAIN STREET
ELVERSON, PA 19520

Model No. (required)	SHIP TO:
_____	Name _____
Serial No. (required)	Address _____
_____	City, State, Zip _____
<input type="checkbox"/> Front seat	() _____
<input type="checkbox"/> Rear seat	Telephone _____
<input type="checkbox"/> Seat pads (front/rear)	<input type="checkbox"/> Check enclosed
<input type="checkbox"/> Front wheel assembly	(payable to Graco Children's Products Inc.)
<input type="checkbox"/> Rear wheel	<input type="checkbox"/> Charge to credit card:
<input type="checkbox"/> Rear axle	<input type="checkbox"/> Visa
<input type="checkbox"/> Front tray	<input type="checkbox"/> MasterCard
<input type="checkbox"/> Rear arm bar	<input type="checkbox"/> Discover
<input type="checkbox"/> Basket	
<input type="checkbox"/> Front canopy	Subtotal: _____
<input type="checkbox"/> Rear canopy	Shipping & handling*: <u> \$5.00 </u>
<input type="checkbox"/> Swivel lock button	6% sales tax (PA only): _____
	Account #: _____
	Expiration date: _____
	Signature: _____
Total: _____	
* \$15.00 outside the continental U.S.	

Free Manuals Download Website

<http://myh66.com>

<http://usermanuals.us>

<http://www.somanuals.com>

<http://www.4manuals.cc>

<http://www.manual-lib.com>

<http://www.404manual.com>

<http://www.luxmanual.com>

<http://aubethermostatmanual.com>

Golf course search by state

<http://golfingnear.com>

Email search by domain

<http://emailbydomain.com>

Auto manuals search

<http://auto.somanuals.com>

TV manuals search

<http://tv.somanuals.com>