

# iHome®

Model: iDM11

***Portable Rechargeable  
Bluetooth Speaker  
with Speakerphone***

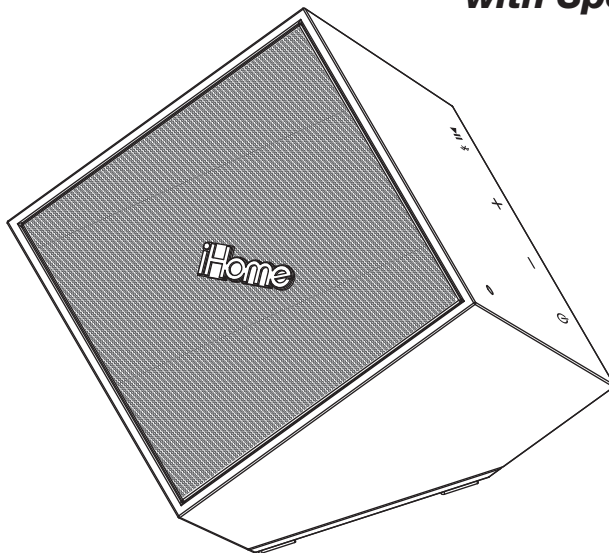

**Questions? Visit [www.ihomeaudio.com](http://www.ihomeaudio.com)**

Download from [Www.Somanuals.com](http://Www.Somanuals.com). All Manuals Search And Download.

## Introduction

Thank you for purchasing this unit. This product is designed to provide high quality wireless sound for your iPad, iPhone, iPod, computer, PDA or other Bluetooth audio device. Along with the included Quick Bluetooth Connection Guide, this instruction booklet explains the basic operation and care of the unit. Please read them carefully and keep for future reference.

## Maintenance

- Place the unit on a level surface away from sources of direct sunlight or excessive heat.
- Protect your furniture when placing your unit on a natural wood and lacquered finish. A cloth or other protective material should be placed between it and the furniture.
- Clean your unit with a soft cloth moistened only with mild soap and water. Stronger cleaning agents, such as Benzene, thinner or similar materials can damage the surface of the unit.

## Table of Contents

Meet Your Unit .....	1-2
Charging the Unit .....	3
Using Bluetooth: Pairing Your Device .....	4
Playing Audio Via Bluetooth .....	5
Using the Speakerphone .....	5
Playing Audio Via Aux/ Troubleshooting .....	6
Consumer Product Safety Guide .....	7



is a registered trademark of SRS Labs, Inc. TruBass technology is incorporated under license from SRS Labs, Inc.

SRS WOW®, which features TruBass®, significantly improves the playback quality of audio, delivering a dynamic 3D soundstage from your music. [www.SRS Labs.com](http://www.SRS Labs.com) All Manuals Search And Download.

# FCC Information

FCC ID:EMOIDM11  
IC:986B-IDM11

## **FCC Radiation Exposure Statement**

This equipment complies with FCC RF radiation exposure limits set forth for an uncontrolled environment. This transmitter must not be co-located or operating in conjunction with any other antenna or transmitter.

This Device complies with RSS-210 of the IC Rules; Operation is subject to the following two conditions:

- (1) This device may not cause interference and
- (2) This device must accept any interference received, including interference that may cause undesired operation

This device complies with Part 15 of the FCC Rules, operation is subject to the following two conditions: (1) This device may not cause harmful interference, and (2) this device must accept any interference received, including interference that may cause undesired operation.

This equipment complies with the limits for a Class B digital device as specified in Part 15 of FCC Rules. These limits provide reasonable protection against radio and TV interference in a residential area.

However, your equipment might cause TV or radio interference even when it is operating properly. To eliminate interference you can try one or more of the following corrective measures:

- Reorient or relocate the receiving antenna.
- Increase the distance between the equipment and the radio or TV.
- Use outlets on different electrical circuits for the equipment and the radio or TV.
- Consult your dealer or an experienced radio/television technician if the problem still exists.

Modifying or tampering with your system's internal components can cause a malfunction and might invalidate the system's warranty and void your FCC authorization to operate it.

This Class B digital apparatus complies with Canadian ICES-003.

Cet appareil numérique de la classe B est conforme à la norme NMB-003 du Canada.

# Internal Rechargeable Lithium-ion Battery

This device uses an internal rechargeable lithium-ion battery that should last the lifetime of the device. If you suspect your battery may be dead, try charging it several times. If the battery does not recharge, please contact us for repair information.

## WARNING/DISPOSAL OF UNIT

Please do NOT attempt to change the battery yourself. If the battery has died and you do not want us to replace your battery, you should follow the disposal instructions below:

- Never dispose of used batteries/electronics with ordinary solid wastes, since they contain toxic substances.
- Always dispose of used batteries/electronics in accordance with the prevailing community regulations that apply to the disposal of batteries/electronics. If there are no local regulations concerning battery/electronics disposal, please dispose of the device in a waste bin for electronic devices.
- Many electronics retailers now recycle batteries and other electronic components at no charge. Check to see which ones in your area do so.

## CAUTION

**The battery used in this device may present a risk of fire, explosion or chemical burn if mistreated**

- Never use or charge the battery if it appears to be leaking, discolored, deformed, or in any way abnormal.
- Never disassemble the unit or attempt to remove battery as that could cause leakage of alkaline solution or other electrolytic substance.
- Always confirm that the temperature is 5°C – 35° C (41° - 95° Fahrenheit) before you charge the battery. Leakage or deterioration of the battery may occur if this warning is not heeded.
- Never expose the battery to any liquid.
- Never expose the battery to excessive heat such as direct sunlight or fire. Never use the battery pack in an unventilated vehicle where excessive internal temperatures may be encountered.
- Always keep the battery out of the reach of infants and small children.

# Meet Your Unit

## Top/Front of Speaker

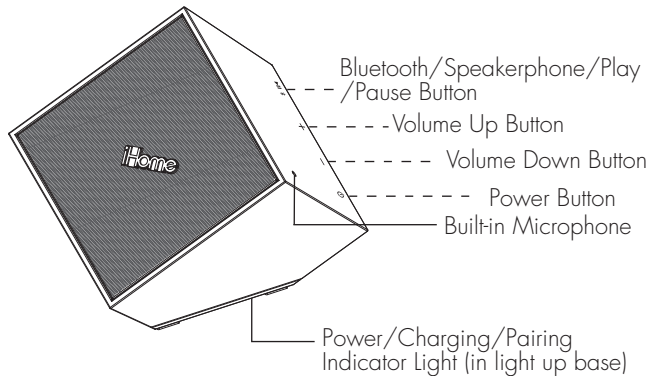

## Rear of Speaker

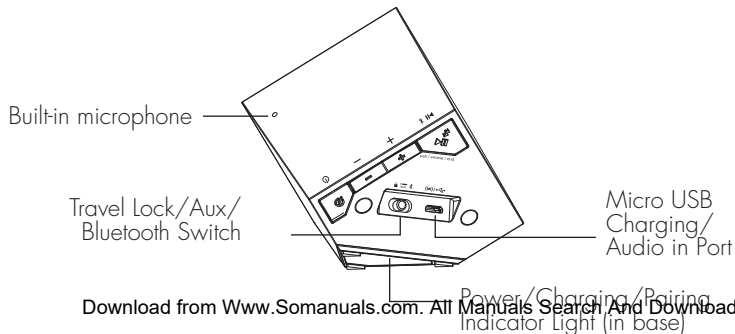

# Meet Your Unit

## Included

- iDM11 system (1 speaker)
- 24 inch micro USB to USB/3.5 mm charging and aux. audio cable

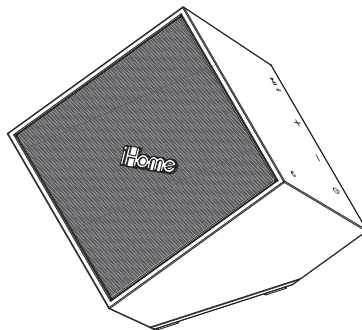

## Travel Lock:

- Move the Travel Lock switch on the back of the speaker to the  position to temporarily disable the unit and prevent accidental button activation during travel that might drain the battery. Move switch to Bluetooth or Aux position for normal operation.

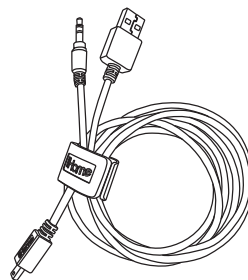

## Charging the Unit

1. Connect the micro USB plug to the micro USB charging port on the back of the speaker.
2. Connect the standard USB plug end of the cable to a powered USB port on a computer or other USB charging device. For first time use, charge unit for about 8 hours.
3. A red light pulses slowly through the base while the unit is charging and glows steadily **blue** once unit is fully charged.

NOTE: When the unit is ON and not connected to power source, a pulsing blue light indicates low battery (25% - 10%), and a quickly flashing red light indicates battery needs charging (less than 10%).

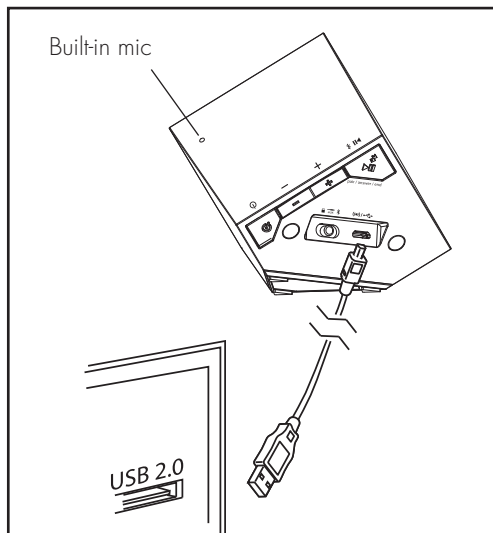

## Using Bluetooth: Pairing Your Device

**NOTE:** See the iDM11 Bluetooth Connection Guide for complete pairing details.

1. Move the **Travel Lock/Aux/Bluetooth Switch** on the back of the speaker to the Bluetooth position (right).
2. Press and hold the **⏻ Button** to turn on the unit (release when a light appears on the base).
3. Turn on Bluetooth capability on your device and make it discoverable (see your device's instructions to add or setup a Bluetooth device).
4. *Press and hold* the **Bluetooth/Speakerphone Button** on the unit until the base flashes red and blue alternately and the unit beeps twice to indicate pairing attempt. The lights will flash while the unit attempts to pair. If your device asks for a password, enter **1234** on the keyboard of your device. If no device is paired within 2 minutes, the base will glow red for 2 seconds accompanied by a long beep and the unit will power off. If this occurs, retry steps 2-4.
5. Once paired with a device, a blue light will glow steadily and two beeps will confirm that pairing is complete. There should also be an indication on your device that pairing is complete. On some devices, you must then select "use as a stereo audio device" or similar on the device's Bluetooth menu. Once paired, your device should link to the iDM11 whenever within range.



## Playing Audio Via Bluetooth

1. Move the **Travel Lock/Aux/Bluetooth Switch** to the Bluetooth position to listen to audio streamed wirelessly from your paired iPad, iPhone, iPod or other Bluetooth device.
2. Press and hold the **⏻ Button** for 2 seconds to turn on the unit. The blue light will flash as the unit searches for a previously paired device, and then turn solid blue when a previously paired device is detected.
3. Press and release the **📶 ▶️ Button** to play or pause audio from your Bluetooth device.  
**NOTE:** Play/Pause only works in Bluetooth mode. It does not control aux line-in devices.
4. Use the **Volume +/- Buttons** to adjust volume.
5. When done listening, press and hold the **⏻ Button** for 2 seconds to turn the unit off.

## Using the Speakerphone

1. Move the **Travel Lock/Aux/Bluetooth Switch** to the Bluetooth position to use the speaker as a speakerphone for a linked Bluetooth-capable phone during an incoming or active call.
3. Press and hold the **⏻ Button** to turn on the unit (release when blue light appears).
4. Use the **Volume +/- Buttons** to adjust volume. You may wish to adjust the volume on your audio device, too.
5. When a call is received, playing music is muted to hear the ring tone. Press the **📶 ▶️ Button** to answer the call, or press the **⏻ Button** to ignore it.
6. When the call is completed, press the **⏻ Button** or **📶 ▶️ Button** to end the call and resume previous function.

## Playing Audio via Aux

1. Move the **Travel Lock/Aux/Bluetooth Switch** to the Aux position to listen to audio via aux line-in.
2. Connect the micro USB plug to the micro USB charging port on the back of the speaker and connect the 3.5 mm audio plug to the headphone or line-out jack on your audio device.
4. Press and hold the **⏻ Button** to turn on the unit (release when blue light appears).
5. Use the **Volume +/- Buttons** to adjust volume. You may wish to adjust the volume on your audio device, too.
6. When done listening, press and release the **⏻ Button** to turn the unit off. Remember to turn off your audio device, too.

## Troubleshooting

### Unit doesn't respond (no power)

- Make sure unit is completely charged. Check that all connections are correct and properly plugged in. Make sure your device is properly paired with the iDM11.
- Make sure the **Travel Lock/Aux/Bluetooth Switch** is not in the **🔒** position, as this will disable operation.

### Resetting the unit

If the unit does not respond properly or appears to be “frozen”, you may wish to try resetting it. To do so, press and hold the **Power Button** and the **Volume + Button** simultaneously for about 3 seconds. Doing so will restore the unit to default settings. *NOTE:* After a reset, you will need to re-pair your Bluetooth device(s).

### Trouble pairing device/computer with iDM11

Bluetooth implementation varies depending on your computer's hardware and operating system. Please see our website for updates on pairing.

- Make sure you have the latest firmware for your iPad, iPhone or iPod (update via iTunes if needed).
- Make sure your device is working properly. Check your device's manual for details on Bluetooth pairing and linking.

For further information and to see the latest instructions, visit [www.ihomeaudio.com/support](http://www.ihomeaudio.com/support)

# Consumer Product Safety Guide

## IMPORTANT SAFETY INSTRUCTIONS

When used in the directed manner, this unit has been designed and manufactured to ensure your personal safety. However, improper use can result in potential electrical shock or fire hazards. Please read all safety and operating instructions carefully before installation and use, and keep these instructions handy for future reference. Take special note of all warnings listed in these instructions and on the unit.

1. **Water and Moisture** – The unit should not be used near water. For example: near a bathtub, washbowl, kitchen sink, laundry tub, swimming pool or in a wet basement.
2. **Ventilation** – The unit should be situated so that its location or position does not interfere with its proper ventilation. For example, it should not be situated on a bed, sofa, rug or similar surface that may block ventilation openings. Also, it should not be placed in a built-in installation, such as a bookcase or cabinet, which may impede the flow of air through the ventilation openings.
3. **Heat** – The unit should be situated away from heat sources such as radiators, heat registers, stoves or other appliances (including amplifiers) that produce heat.
4. **Power Sources** – The unit should be connected to a power supply only of the type described in the operating instructions or as marked on the appliance.
5. **Power-Cable Protection** – Power supply cables should be routed so that they are not likely to be walked on or pinched by items placed upon or against them. It is always best to have a clear area from where the cable exits the unit to where it is plugged into an AC socket.
6. **Cleaning** – The unit should be cleaned only using a warm damp cloth. Do not use solvents, etc.
7. **Objects and Liquid Entry** – Care should be taken so that objects do not fall and liquids are not spilled into any openings or vents located on the product.
8. **Attachments** – Do not use attachments not recommended by the product manufacturer.
9. **Lightning and Power Surge Protection** – Unplug the unit from the wall socket and disconnect the antenna or cable system during a lightning storm or when it is left unattended and unused for long periods of time. This will prevent damage to the product due to lightning and power-line surges.
10. **Overloading** – Do not overload wall sockets, extension cords, or integral convenience receptacles as this can result in a risk of fire or electric shock.
11. **Damage Requiring Service** – The unit should be serviced by qualified service personnel when:
  - A. the power supply cable or plug has been damaged.
  - B. objects have fallen into or liquid has been spilled into the enclosure.
  - C. the unit has been exposed to rain.
  - D. the unit has been dropped or the enclosure damaged.
  - E. the unit exhibits a marked change in performance or does not operate normally.
12. **Periods of Nonuse** – If the unit is to be left unused for an extended period of time, such as a month or longer, the power cable should be unplugged from the unit to prevent damage or corrosion.
13. **Servicing** – The user should not attempt to service the unit beyond those methods described in the user's operating instructions. Service methods not covered in the operating instructions should be referred to qualified service personnel.

Questions? Visit [www.ihomeaudio.com](http://www.ihomeaudio.com)  
or call 1-800-288-2792 Toll Free

Download from [Www.Somanuals.com](http://Www.Somanuals.com). All Manuals Search And Download.

## Limited 90 Day Warranty

iHome Products, a division of SDI Technologies Inc. (hereafter referred to as SDI Technologies), warrants this product to be free from defects in workmanship and materials, under normal use and conditions, for a period of 90 days from the date of original purchase. Should this product fail to function in a satisfactory manner, it is best to first return it to the store where it was originally purchased. Should this fail to resolve the matter and service still be required by reason of any defect or malfunction during the warranty period, SDI Technologies will repair or, at its discretion, replace this product without charge (except for a \$10.00 charge for handling, packing, return UPS/postage, and insurance). This decision is subject to verification of the defect or malfunction upon delivery of this product to the Factory Service Center listed below. The product must include proof of purchase, including date of purchase. The fee for service without proof of purchase is \$35.00.

Before returning this product for service, please first replace the batteries (if applicable) with fresh ones, as exhausted or defective batteries are the most common cause of problems encountered.

If service is still required:

1. Remove the batteries (if applicable) and pack the unit in a well padded, heavy corrugated box.
2. Enclose a photocopy of your sales receipt, credit card statement, or other proof of the date of purchase, if within the warranty period.
3. Enclose a check or money order payable to the order of SDI Technologies, for the sum of \$10.00 (\$35.00 without proof of purchase).
4. Send the unit prepaid and insured, to the Factory Service Center listed below.

### Consumer Repair Department

SDI Technologies Inc.  
1330 Goodyear Drive  
El Paso, TX 79936-6420

### Disclaimer of Warranty

**NOTE:** This warranty is valid only if the product is used for the purpose for which it was designed. It does not cover (i) products which have been damaged by negligence or willful actions, misuse or accident, or which have been modified or repaired by unauthorized persons; (ii) cracked or broken cabinets, or units damaged by excessive heat; (iii) damage to digital media players, CD's or tape cassettes (if applicable); (iv) the cost of shipping this product to the Factory Service Center and its return to the owner.

This warranty is valid only in the United States of America and does not extend to owners of the product other than to the original purchaser. In no event will SDI Technologies or any of its affiliates, contractors, resellers, their officers, directors, shareholders, members or agents be liable to you or any third party for any consequential or incidental damages, any lost profits, actual, exemplary or punitive damages. (Some states do not allow limitations on implied warranties or exclusion of consequential damages, so these restrictions may not apply to you.) This warranty gives you specific legal rights, and you may also have other rights which vary from state to state.

Your acknowledgement and agreement to fully and completely abide by the above mentioned disclaimer of warranty is contractually binding to you upon your transfer of currency (money order, cashier's check, or credit card) for purchase of your SDI Technologies product.

© 2011 SDI Technologies, Inc. All rights reserved

Questions? Visit [www.ihomeaudio.com](http://www.ihomeaudio.com) or call 1-800-288-2792 Toll Free.

## Free Manuals Download Website

<http://myh66.com>

<http://usermanuals.us>

<http://www.somanuals.com>

<http://www.4manuals.cc>

<http://www.manual-lib.com>

<http://www.404manual.com>

<http://www.luxmanual.com>

<http://aubethermostatmanual.com>

Golf course search by state

<http://golfingnear.com>

Email search by domain

<http://emailbydomain.com>

Auto manuals search

<http://auto.somanuals.com>

TV manuals search

<http://tv.somanuals.com>