

*TrueAir*<sup>™</sup>

**READ BEFORE USE**

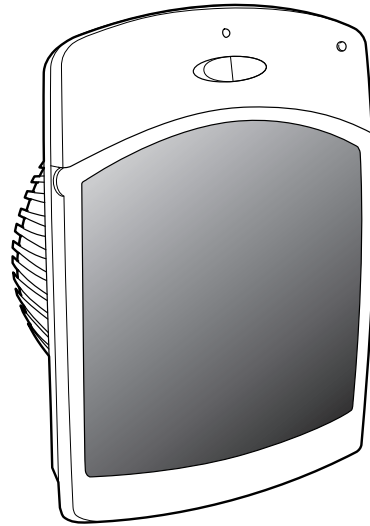

English ..... 2  
USA: 1-800-851-8900  
Canada : 1-800-267-2826

840121000

## IMPORTANT SAFEGUARDS

When using electrical appliances, basic safety precautions should always be followed including the following:

1. Read all instructions before using the appliance.
2. To reduce the risk of fire or shock hazard, plug the appliance directly into a 120V AC electrical outlet.
3. To protect against electrical hazards do not immerse in water or other liquids.
4. Close supervision is necessary when any appliance is used by or near children, or by invalids.
5. Always unplug the appliance before moving it, opening the grill, changing filters, before cleaning, or whenever the appliance is not in use.
6. Do not put foreign objects inside the appliance.
7. Do not operate any appliance with a damaged plug, if fan fails to rotate, or after the appliance malfunctions or has been dropped or damaged in any manner. Return the appliance to Hamilton Beach/Proctor-Silex for examination, electrical or mechanical adjustment or repair.
8. Use the appliance only for intended household use as described in this manual.
9. Do not use outdoors.
10. Never block the air opening.
11. Keep away from heated surfaces.
12. This appliance is NOT a toy.
13. Do not use the TrueAir™ odor eliminator in unheated areas such as a garage or porch.

**READ AND SAVE  
THESE INSTRUCTIONS**

2

## Consumer Safety Information

- This appliance is intended for household use only.
- Do not immerse in water.
- Do not install the unit where water can splash on it or near an open window.
- Do not place foreign objects inside the unit.
- Do not use appliance with a customized or non-standard outlet.
- Do not obstruct the vents. Keep clear of drapes and furniture.
- Not suitable for use in hazardous locations such as in the presence of flammable or volatile vapors.
- Instruct children never to interfere with the unit.
- Do not use with extension cords or multi-plug adaptors.
- Use with a properly functioning electrical outlet only.
- **WARNING:** To reduce the risk of fire or electric shock, do not use this fan with any solid-state speed control device or dimmer switch.
- This product is not a toy. For adult use only.
- Do not use near cooking areas. This appliance is not intended to be used as an exhaust fan to remove smoke and grease resulting from cooking.

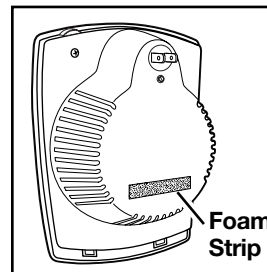

The foam strip is to maintain proper placement and quiet operation. Do not remove.

3

## Parts and Features

1. Opening Tabs
2. Vents
3. Housing
4. Filter Status/  
Power Indicator Light
5. Reset Button
6. Control Switch
7. Filter
8. Grill

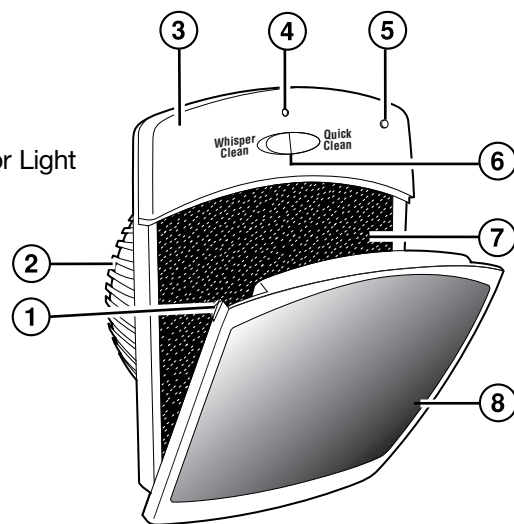

### Reset Button

- The Filter Status/Power Indicator Light will glow when the unit is turned on. The green light will turn red when 14 days of the 120-day filter life remain to remind you to purchase a replacement filter. At the end of 120 filter-life days, the light will flash on and off. Replace filter and insert tip of pen into reset button to reset the 120-day filter counter. The green light will blink twice to indicate unit has been reset.
- The unit will remember the amount of usage prior to a power outage and begin counting days again when power is restored. The unit does not need to be turned on to count filter days.

4

## How to Use

**NOTE:** QuickClean provides a faster fan speed to quickly eliminate odors. WhisperClean provides a fan speed needed to continuously eliminate odors.

1. Open the cover of odor eliminator as illustrated.
2. Remove plastic bag from the filter before installing the filter. Place the filter in the odor eliminator, fitting notched corner of filter around notched edge of odor eliminator.
3. Close the cover of the odor eliminator until it snaps into place.

**NOTE:** The life of the filter is determined by use. If the odor eliminator is used continuously for strong odors, such as a cat litter box or diaper pail, it may need to be replaced at 1 month. If only used occasionally, such as in a guest bathroom, it may last longer.

4. Plug in odor eliminator as illustrated.

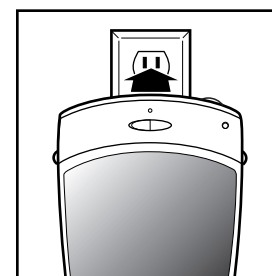
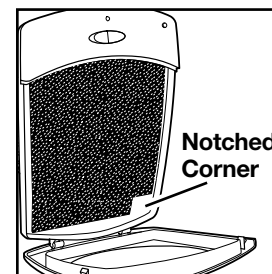
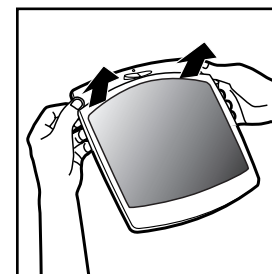

5

#### To rotate the swivel plug:

- Loosen screw with Philips screwdriver until screw pops out allowing the plug assembly to rotate.
- Rotate plug 90° to desired tab position and retighten screw.

**NOTE:** Outlets in older homes may not hold the odor eliminator securely. If the odor eliminator seems “loose” within the outlet, please contact a qualified electrician to replace the obsolete outlet.

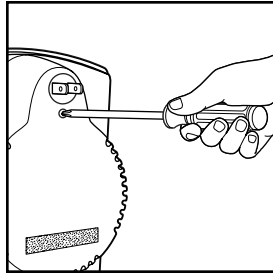

5. Turn ON; the green light will indicate that the unit is on.

**NOTE:** You may leave the odor eliminator on constantly or only use occasionally for strong odors. The odor eliminator is designed to work best when plugged in within six feet of the odor source.

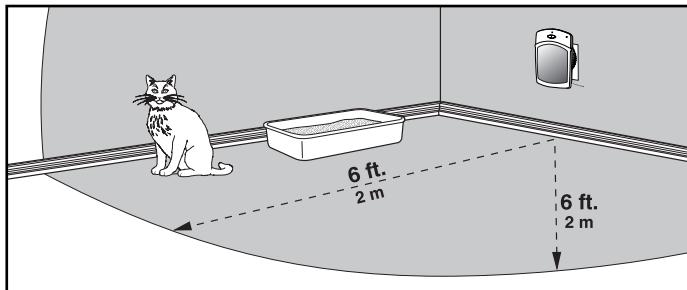

6

## Cleaning

1. Turn off and unplug the odor eliminator before cleaning.
2. Wipe the exterior housing with a clean, dry cloth only.
3. To clean the grill, wipe with a damp cloth or use a vacuum cleaner to remove lint or debris.
4. Do not use detergents, solvents, or spray cleaners.

**Do not immerse unit in water or other liquid.**

## To Replace the Filter

**NOTE:** A filter should last 1 to 4 months, depending on use.

1. Turn off and unplug the odor eliminator. Open cover of odor eliminator and remove the used filter.
2. Discard used filter. Remove plastic bag from new filter before installing. Use only Hamilton Beach TrueAir™ filters.
3. Press the reset button. The Filter Status/Power Indicator Light will continue to blink red until it has been reset.

## Customer Service

If you have a question about your odor eliminator, call our toll-free customer service number. Before calling, please note the model, type, and series numbers and fill in that information below. These numbers can be found on the back of your odor eliminator. This information will help us answer your question much more quickly.

**MODEL:** \_\_\_\_\_ **TYPE:** \_\_\_\_\_ **SERIES:** \_\_\_\_\_

7

**This warranty applies to product purchased in the U.S.  
or Canada.**

**LIMITED WARRANTY**

This product is warranted to be free from defects in material and workmanship for a period of two (2) years for Hamilton Beach Portfolio products, one (1) year for Hamilton Beach products or one hundred eighty (180) days for Proctor-Silex products from the date of original purchase, except as noted below. During this period, we will repair or replace this product, at our option, at no cost. THE FOREGOING WARRANTY IS IN LIEU OF ANY OTHER WARRANTY, WHETHER EXPRESS OR IMPLIED, WRITTEN OR ORAL INCLUDING ANY WARRANTY OF MERCHANTABILITY OR FITNESS FOR A PARTICULAR PURPOSE. ANY LIABILITY IS EXPRESSLY LIMITED TO AN AMOUNT EQUAL TO THE PURCHASE PRICE PAID, AND ALL CLAIMS FOR SPECIAL, INCIDENTAL AND CONSEQUENTIAL DAMAGES ARE HEREBY EXCLUDED. There is no warranty with respect to the following, which may be supplied with this product: the filter. This warranty extends only to the original consumer purchaser and does not cover a defect resulting from abuse, misuse, neglect, use for commercial purposes, or any use not in conformity with the printed directions. This warranty gives you specific legal rights, and you may also have other legal rights which vary from state to state, or province to province. Some states or provinces do not allow limitations on implied warranties or special, incidental or consequential damages, so the foregoing limitations may not apply to you.

If you have a claim under this warranty, DO NOT RETURN THE APPLIANCE TO THE STORE! Please call our CUSTOMER SERVICE NUMBER. (For faster service please have model, series, and type numbers ready for operator to assist you.)

**CUSTOMER SERVICE NUMBERS**

In the U.S. 1-800-851-8900

In Canada 1-800-267-2826

[trueair.com](http://trueair.com)

**KEEP THESE NUMBERS FOR FUTURE REFERENCE!**

HAMILTON BEACH ♦ PROCTOR-SILEX, INC.  
263 Yadkin Road, Southern Pines, NC 28387

PROCTOR-SILEX CANADA, INC.  
Picton, Ontario K0K 2T0

840121000

[trueair.com](http://trueair.com)

2/04

## Free Manuals Download Website

<http://myh66.com>

<http://usermanuals.us>

<http://www.somanuals.com>

<http://www.4manuals.cc>

<http://www.manual-lib.com>

<http://www.404manual.com>

<http://www.luxmanual.com>

<http://aubethermostatmanual.com>

Golf course search by state

<http://golfingnear.com>

Email search by domain

<http://emailbydomain.com>

Auto manuals search

<http://auto.somanuals.com>

TV manuals search

<http://tv.somanuals.com>