

INSTALLATION INSTRUCTIONS

GENERAL INFORMATION

The 5894PI Passive Infrared Motion Detector/Transmitter is a 10-year battery-operated wireless device intended for use as part of a 5800 series wireless alarm system.

Designed for use in commercial and residential installations, the 5894PI is a wall-mounted unit with a standard lens that provides wide-angle protection up to a range of 35 ft (10.6m). For best coverage, mount the detector so that the likely direction of intruder motion is **across** the pattern.

When installed per the guidelines, the Tier-Balanced Optics technology in the 5894PI provides false alarm protection against pets and other animals up to 80 lbs.

This document provides installation instructions for the 5894PI, but the installer must be familiar with the installation instructions for the 5800 Wireless Alarm System with which the 5894PI is intended to be used.

FEATURES

- Tier-Balanced Optics provides pet immunity against animals up to 80 lbs.
- Wireless operation for fast installation.
- Dual-element pyroelectric sensor provides positive protection while minimizing false alarms.
- Selectable PIR sensitivity.
- Provision to turn LED on while Walk Testing (LED is turned off after testing).
- Tamper-protected cover and wall; detector transmits message if cover or detector is removed.
- Wall or corner mounting options.
- Patented Black Bug Guard.
- Temperature compensation.

SYSTEM DESCRIPTION

Optical System

The 5894PI uses efficiently designed Fresnel lenses with Tier-Balanced Optics.

Radio Transmitter

The built-in transmitter serves only as the communication link to the alarm system's Receiver/Control, and can send alarm, tamper, supervisory, and battery status messages to the system's receiver/control. The transmitter is not used for detection purposes. Each detector has a unique ID code permanently assigned at the factory. You must enroll this ID into the control system at the time of installation. This allows each detector used in the system to be uniquely identified. You must program the control to enroll the 5894PI as an "RF" type unit (i.e., supervised RF).

To conserve battery life during normal operation, no more than one transmission sequence will occur within a 3-minute period. There is no such time restriction in Test mode (refer to the Walk Test section).

SPECIFICATIONS

Pet Immune Lens:

35 ft x 45 ft (10.6m x 13.7m).
28 zones (8 over, 8 long range, 8 intermediate, 4 short-range).

Pulse Processing:

Intermediate, Standard, or Harsh, Installer-selectable. **Note: For pet immune applications, see Special Instructions for Installations with Pets on page 3.**

Detectable Walk Rate:

0.5–10 ft/Sec (0.15–3m/Sec).

Mounting Height:

7.0 ft (2.1m)

Walk Test Indicator:

Red LED with enable/disable link.

Batteries:

Three 3-volt Lithium batteries. Use only ADEMCO No. 466, Duracell DL123A, Panasonic CR123A, Sanyo CR123A, or Varta CR123A.

Operating Temperature:

32°F – 122°F (0°C – 50°C).

Operating Humidity:

Up to 95% RH (max.), non-condensing.

Dimensions:

3.0"W 5.0"H x 1.7"D
(76.3mm x 127.0mm x 42.6mm).

Approvals/Listings:

FCC, IC, cULus, C-Tick

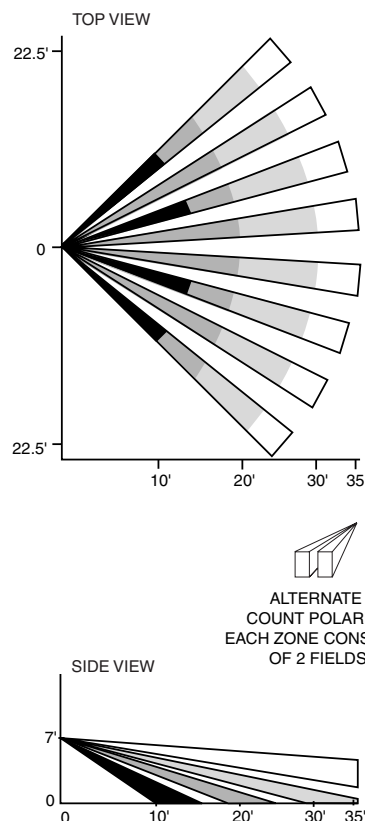

Figure 1. Protection Pattern

BATTERY ACTIVATION/INSTALLATION

1. Remove front cover by pressing the front cover latch and lifting the cover off. See Figure 2.

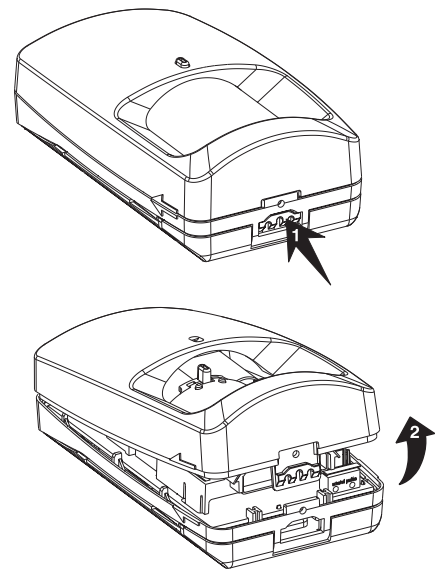

Figure 2. Remove the Front Cover

2. To *activate* the installed batteries, remove the battery pull-tab. (See Figure 3.) Make sure the batteries remain firmly seated in the battery holders.

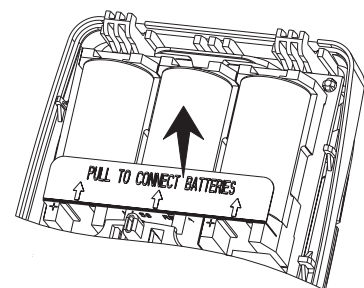

Figure 3. Remove Pull Tab to activate batteries

3. To *replace* the batteries, remove the old batteries from the holder. Then, **observing correct polarity**, install three new Lithium batteries into the battery holders, as shown in Figure 4. Make sure the batteries are firmly seated.
4. Replace the cover (snap fit).

Battery Caution

Risk of fire, explosion, and burns. Do not recharge, disassemble, heat above 100°C, or incinerate. Dispose of used batteries promptly. Keep away from children.

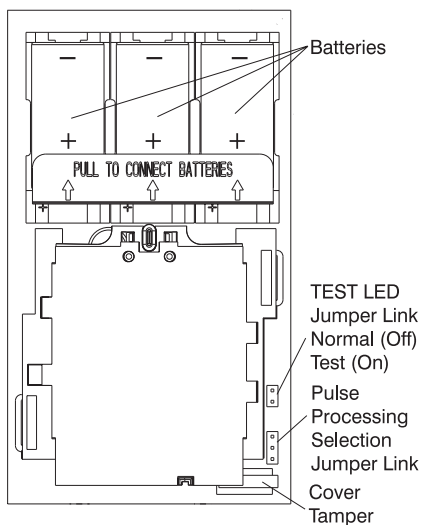

Figure 4. Printed Circuit Board (PCB)

Programming Note: If you have not programmed the detector's ID into the system (i.e., this is an initial detector installation), refer to the *PROGRAMMING* section below and perform the ID enrolling procedure before mounting or testing the detector.

PULSE PROCESSING OPTION

See Figure 4 for location of Pulse Processing selection jumper link.

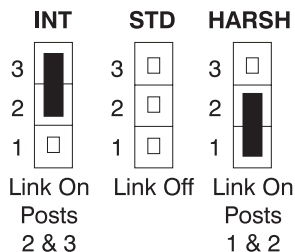

Figure 5. Pulse Processing Options

Intermediate Pulse Processing (INT) [High Sensitivity]: This setting is recommended for any location where an intruder is expected to cover only a small portion of the protected area. The detector tolerates normal environments on this setting.

Note: INT pulse processing is NOT recommended for pet immune applications.

Standard Pulse Processing (STD) [Medium Sensitivity]: This setting is the recommended for most applications. The detector tolerates environmental extremes on this setting.

Note: STD pulse processing is recommended for pet immune applications.

Harsh Pulse Processing (HARSH) [Low Sensitivity]: This setting is recommended for the severest of environments and should only be used in locations where an intruder is expected to cover moderate to large portions of the protected area.

PROGRAMMING

You must enroll the detector's ID during installation of the system. **You should program the 5894PI as an "RF" type unit (i.e., supervised RF), and the "Loop" number as "1."**

To program the detector, place the LED jumper in the TEST position (see Figure 4), the Pulse Count jumper in the STD position (see Figure 5), batteries installed and cover on. Temporarily cover the lens (a cloth will do) to prevent any activation by the detector.

When prompted for the device's serial number, you may either manually enter it or transmit from the unit (remove the cloth cover and motion your hand over the lens to activate the detector). Refer to the control panel installation instructions for programming details.

Remove the LED jumper to disable the LED (NORMAL position).

INSTALLATION

Installation Hints

- Do not install where the detector is exposed to direct sunlight or directly above strong sources of heat.
- Make sure the detection area does not have obstructions (curtains, screens, large pieces of furniture, plants, etc.) that may block the pattern of coverage.
- Avoid locating a unit in areas that contain objects likely to produce a rapid change in temperature, such as central heating, radiators, or ducts (or heaters of any kind), air conditioners, open flame, etc.
- Do not mount on an unstable surface.

RADIO TRANSMISSION PATH CHECK

Verify that a strong transmission path between the 5894PI and the system's Receiver/Control exists **before permanently mounting the detector**. Do this by performing the *Walk Test* (described later) with the detector temporarily mounted in its proposed location. The 5894PI will transmit when sensing motion (such as a person waving an arm or walking into an area). Sometimes, moving the detector only a few centimeters means the difference between a strong and weak transmission path. Experiment until you are satisfied that the location provides the strongest transmission path, yet is still practical for the protection pattern desired. This test also verifies that the detector has been correctly programmed into the system.

MOUNTING

Mount the unit to a firm vertical surface (flat on a wall or in a corner).

- Hold the mounting plate in one hand and slide the detector in the direction of the arrows molded on the outside of the plastic housing.

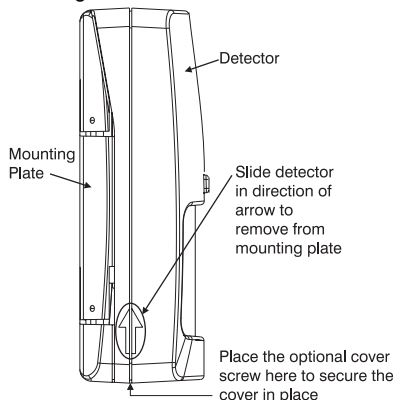

Figure 6. 5894PI Side View

- Use the mounting plate to mark the mounting holes on the mounting surface (See Figure 7).

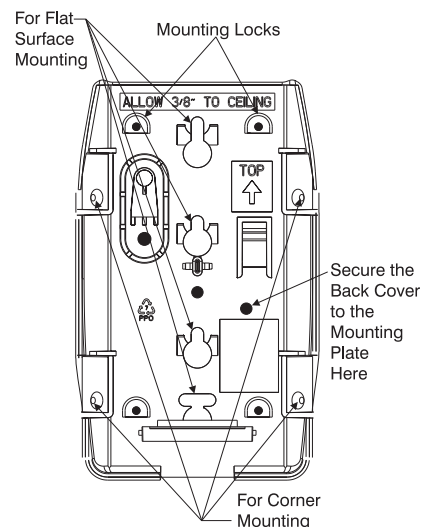

Figure 7. Mounting Plate

- Install the detector mounting plate using the hardware kit provided.
- Align the detector base over the mounting locks on the mounting plate, press the detector onto the locks and slide down until firmly locked into position.

Note: For battery replacement or service, slide the mounted detector in the direction of the arrows molded into the side of the detector to dismount the detector.

- Note:** Mounting Accessories also available:
- SMB-10 Swivel Mount Bracket (P/N 0-000-110-01)
 - SMB-10T Tampered Swivel Mount Bracket (P/N 0-000-155-01)
 - SMB-10C Ceiling Mount Bracket (P/N 0-000-111-01)

Note: Swivel Mount Brackets should not be used in pet applications.

LENS MASKING

The masking strips that have been supplied (Masking Kit P/N K9086) are designed for application to one or more lens segments to produce a protection pattern that suits the particular requirements of the protected area. Individual masking strips have been provided for each of the lens segments on the standard lens supplied with the PIR. Simply peel off the appropriate pressure-sensitive adhesive strip(s) and apply over the desired lens segment(s). Be sure to affix the masking strips to the *inside* of the lens (not the outer, smooth side). Each lens segment that is masked results in the elimination of one zone of protection from the coverage pattern. By masking segments of the lens, you can adjust the coverage to suit the area to be protected, or eliminate coverage from areas where you anticipate environmental disturbances that might reduce the PIR's stability (a heater or other heat-producing object for example).

Important: When hallway pattern masking is used, be sure the PIR is set for instant response.

TEST PROCEDURES

Important: Testing should be conducted with the protected area cleared of all people. Place the protective system's control in the Test mode for the Walk Test procedure. When the PIR senses movement, the system's console emits a beep, verifying that the PIR's transmitter signal has reached the control's wireless receiver.

The absolute range of all PIR units is subject to variation because of different types of clothing, backgrounds, and ambient temperature. For this reason, ensure that the most likely intruder routes are well within the PIR's protective zones and that Walk Testing is carried out along these routes.

WALK TEST

Test mode is initiated by removing and replacing the detector's front cover, or by removing and replacing the sensor from the mounting plate.

Note: Each time you remove and replace the front cover, or remove and replace the sensor in the mounting plate, the sensor will transmit every alarm signal for 64 alarm events.

1. Remove front cover, and set the pulse count jumper as required in the installation (INT, STD or HARSH),
2. Enable the LED by placing the jumper link in the TEST position (see Figure 4 for jumper location).

Note: Removing the front cover, or removing the sensor from the mounting plate, will also enable the LED.

3. Replace front cover and walk through protective zones, observing that the detector's LED lights whenever motion is detected (the LED serves as a Walk Test indicator during this procedure).
4. **After the Walk Test is completed, disable the LED by placing the LED jumper link in the Normal position. Failing to do so will reduce the battery life.** (see Figure 4.)

MAINTAINING PROPER OPERATION

In order to maintain the detector in proper working condition, it is important that the user observes the following:

1. Replace **all three** batteries within seven (7) days after a "low battery" message has appeared in the system's display.
2. Detectors should never be re-aimed or relocated without the advice or assistance of the alarm service company.
3. The physical surroundings of the protected area should not be changed. If furniture or stock is moved, or air conditioning or additional heating is installed, the PIR may have to be readjusted.
4. Walk Tests should be conducted frequently (at least weekly) to confirm continued proper coverage.

SPECIAL INSTRUCTIONS FOR INSTALLATION WITH PETS

To take full advantage of the pet immunity in the 5894PI, the guidelines below should be followed:

- Mount the center of the detector 7.0 feet high.
- **Set the Pulse Count to Standard or Harsh.**
- Mount where animals/rodents cannot come within six feet of the detector by climbing on furniture, boxes, or other objects.
- Do not aim the detector at stairways or furniture / objects that can be climbed by an animal.

Note: This unit will provide immunity to false alarms for an individual animal or a group of animals whose total weight is equal to or less than 80 pounds when the room temperature is above 50° F.

TROUBLESHOOTING

Trouble 1: INTERMITTENT ALARM

Probable Causes:

- A. Rapid temperature change. Check for electric or gas heaters, open flames, electric arcs, etc.
Remedy: Locate source and re-position detector.
- B. Drafts causing drapes, light fixtures, display material to move.
Remedy: Eliminate source of motion.

Trouble 2: LED INOPERATIVE DURING WALK TEST

Probable Causes:

- A. LED control jumper set to NORMAL position.
Remedy: Re-position jumper to TEST position (see Figure 4).
- B. LED malfunction. Check for broken/shorted leads.
Remedy: Return unit for service.

Trouble 3: LED OPERATIVE WITH LED JUMPER LINK SET TO NORMAL (OFF) POSITION

Probable Causes:

- A. The sensor is not mounted squarely on the wall, (the wall tamper switch is not depressed.)
Remedy: Re-position the sensor to make sure the wall tamper switch is fully depressed.
- B. The sensor's front cover is not installed.
Remedy: Replace the sensor's front cover.

Trouble 4: SUPERVISION FAILURE

Probable Causes:

- A. When enrolling the detector, a tamper signal was used to transmit the detector serial number, and the panel enrolled the detector with a loop type "4", or the wrong device was learned.
Remedy: Ensure the serial number and loop types are correct for each detector; if the detector loop type is programmed as "4", manually change it to "1" at the panel. If the wrong device was learned, enroll the detector again (see Programming on page 2).
- B. The detector was placed in a location where the RF signal is not strong enough.
Remedy: Repeat the directions to verify the transmission path (see the Radio Transmission Path Check section on page 2). If necessary, move the detector to a new location.

Trouble 5: UNIT DOES NOT APPEAR TO BE OPERATING

Probable Cause:

- A. Unit is not receiving power.
Remedy: Check for appropriate battery voltage. Install new batteries if necessary. Be sure to change all batteries.

Trouble 6: UNIT IS ALWAYS IN TEST MODE

Probable Cause:

- A. The sensor front cover was removed and replaced, or the sensor was removed and replaced in the mounting plate, so the sensor is transmitting every alarm signal for 64 alarm events.
Remedy: Wait for the sensor to transmit 64 alarm events.

LIMITATIONS OF THE PIR MOTION DETECTOR

While the Intrusion Detector is a highly reliable intrusion detection device, it does not offer guaranteed protection against burglary. Any Intrusion Detection device is subject to compromise or failure to warn for a variety of reasons:

- Passive Infrared Motion Detectors can detect intrusion only within the designed ranges as diagrammed in this installation manual.
- Passive Infrared Motion Detectors do not provide volumetric area protection. They do create multiple beams of protection, and intrusion can be detected only in unobstructed areas covered by those beams.
- Passive Infrared Detectors cannot detect motion or intrusion that takes place behind walls, ceilings, floors, closed doors, glass partitions, glass doors, or windows.
- Mechanical tampering, masking, painting, or spraying of any material on the lenses, windows or any part of the optical system can reduce the detection ability of the Passive Infrared Motion Detector.
- Passive Infrared Detectors sense changes in temperature; however, as the ambient temperature of the protected area approaches the temperature range of 90° to 105°F (32° to 40°C), the detection performance can decrease.
- This Passive Infrared Detector will not operate without the appropriate battery installed, or if the battery is weak or improperly connected (i.e., reversed polarity).
- Passive Infrared Detectors, like other electrical devices, are subject to component failure. Even though this equipment is designed to last as long as 10 years, the electronic components in it could fail at any time.

We have cited some of the most common reasons that a Passive Infrared Motion Detector can fail to catch intrusion. However, this does not imply that these are the only reasons, and therefore it is recommended that weekly testing of this type of unit, in conjunction with weekly testing of the entire alarm system, be performed to ensure that the detectors are working properly.

Installing an alarm system may make the owner eligible for a lower insurance rate, but an alarm system is not a substitute for insurance. Homeowners, property owners and renters should continue to act prudently in protecting themselves and continue to insure their lives and property.

We continue to develop new and improved protection devices. Users of alarm systems owe it to themselves and their loved ones to learn about these developments.

FCC Notice: This equipment has been tested and found to comply with the limits for a Class B digital device, pursuant to part 15 of the FCC Rules. These limits are designed to provide reasonable protection against harmful interference in a residential installation. This equipment generates, uses and can radiate radio frequency energy, and if not installed and used in accordance with the instructions may cause harmful interference to radio communications. However, there is no guarantee that interference will not occur in a particular installation.

If this equipment does cause harmful interference to radio or television reception, which can be determined by turning the equipment off and on, the user is encouraged to try to correct the interference by one or more of the following measures:

- 1) Reorient or relocate the receiving antenna,
- 2) Increase the separation between the equipment and receiver,
- 3) Connect the equipment into an outlet on a circuit different from that to which the receiver is connected.
- 4) Consult the dealer or an experienced radio/television technician for help.

Changes or modifications to this equipment not expressly approved by Honeywell may void the user's authority to operate this equipment.

LIMITED WARRANTY

Honeywell International Inc. ("Seller"), 165 Eileen Way, Syosset, New York 11791, warrants its product(s) to be in conformance with its own plans and specifications and to be free from defects in materials and workmanship under normal use and service for 24 months from the date stamp control on the product(s) or, for product(s) not having an Honeywell date stamp, for 12 months from date of original purchase unless the installation instructions or catalog sets forth a shorter period, in which case the shorter period shall apply. Seller's obligation shall be limited to repairing or replacing, at its option, free of charge for materials or labor, any product(s) which is proved not in compliance with Seller's specifications or proves defective in materials or workmanship under normal use and service. Seller shall have no obligation under this Limited Warranty or otherwise if the product(s) is altered or improperly repaired or serviced by anyone other than Honeywell factory service. For warranty service, return product(s) transportation prepaid, to Honeywell Factory Service, 165 Eileen Way, Syosset, New York 11791.

THERE ARE NO WARRANTIES, EXPRESS OR IMPLIED, OF MERCHANTABILITY, OR FITNESS FOR A PARTICULAR PURPOSE OR OTHERWISE, WHICH EXTEND BEYOND THE DESCRIPTION ON THE FACE HEREOF. IN NO CASE SHALL SELLER BE LIABLE TO ANYONE FOR ANY CONSEQUENTIAL OR INCIDENTAL DAMAGES FOR BREACH OF THIS OR ANY OTHER WARRANTY, EXPRESS OR IMPLIED, OR UPON ANY OTHER BASIS OF LIABILITY WHATSOEVER, EVEN IF THE LOSS OR DAMAGE IS CAUSED BY THE SELLER'S OWN NEGLIGENCE OR FAULT.

Seller does not represent that the product(s) it sells may not be compromised or circumvented; that the product(s) will prevent any personal injury or property loss by burglary, robbery, fire or otherwise; or that the product(s) will in all cases provide adequate warning or protection. Customer understands that a properly installed and maintained alarm system may only reduce the risk of a burglary, robbery, fire, or other events occurring without providing an alarm, but it is not insurance or a guarantee that such will not occur or that there will be no personal injury or property loss as a result. CONSEQUENTLY, SELLER SHALL HAVE NO LIABILITY FOR ANY PERSONAL INJURY, PROPERTY DAMAGE OR OTHER LOSS BASED ON A CLAIM THAT THE PRODUCT(S) FAILED TO GIVE WARNING. HOWEVER, IF SELLER IS HELD LIABLE, WHETHER DIRECTLY OR INDIRECTLY, FOR ANY LOSS OR DAMAGE ARISING UNDER THIS LIMITED WARRANTY OR OTHERWISE, REGARDLESS OF CAUSE OR ORIGIN, SELLER'S MAXIMUM LIABILITY SHALL NOT IN ANY CASE EXCEED THE PURCHASE PRICE OF THE PRODUCT(S), WHICH SHALL BE THE COMPLETE AND EXCLUSIVE REMEDY AGAINST SELLER.

This warranty replaces any previous warranties and is the only warranty made by Seller on this product(s). No increase or alteration, written or verbal, of the obligations of this Limited Warranty is authorized.

Honeywell

165 Eileen Way, Syosset, New York 11791

Copyright © 2004 Honeywell International Inc.



K5942V2 7/04

Free Manuals Download Website

<http://myh66.com>

<http://usermanuals.us>

<http://www.somanuals.com>

<http://www.4manuals.cc>

<http://www.manual-lib.com>

<http://www.404manual.com>

<http://www.luxmanual.com>

<http://aubethermostatmanual.com>

Golf course search by state

<http://golfingnear.com>

Email search by domain

<http://emailbydomain.com>

Auto manuals search

<http://auto.somanuals.com>

TV manuals search

<http://tv.somanuals.com>